

ABB solar inverters

Product Manual

UNO-DM-6.0-TL-PLUS-US

(6.0 kW)



The ABB logo, consisting of the letters "ABB" in a bold, red, sans-serif font.



IMPORTANT SAFETY INSTRUCTIONS

This manual contains important safety instructions that must be followed during installation, operation and maintenance of the ABB photovoltaic inverter.



SAVE THESE INSTRUCTIONS!

Keep this document in a safe place near the inverter for easy access during installation, operation and maintenance.



THE INSTALLER MUST READ THIS DOCUMENT IN ITS ENTIRETY BEFORE INSTALLING THIS EQUIPMENT.

The purpose of this document is to support the qualified technician, who has received training and/or has demonstrated skills and knowledge in construction, to install, operate and maintain the inverter. This manual covers only inverter, not any equipment (photovoltaic modules, external disconnects, etc) to which it is connected.

Warranty requirements are included in the Terms and Conditions of sale included with the inverter order; these include proper installation, operation as intended by ABB, and periodic preventative maintenance. NOTE: Any changes not approved by ABB void the warranty.



FCC REMARKS

The equipment has been tested and found to comply with the limits for a Class B digital device, pursuant to Part 15 of the FCC Rules. These limits are designed to provide reasonable protection against harmful interference in a residential installation. This equipment generates, uses and can radiate radio frequency energy and, if not installed and used in accordance with the instructions, may cause harmful interference to radio communications.

However, there is no guarantee that interference will not occur in a particular installation. If this equipment does cause harmful interference to radio or television reception, which can be determined by turning the equipment off and on, the user is encouraged to try to correct the interference by one or more of the following measures:

- Reorient or relocate the receiving antenna.*
- Increase the separation between the equipment and receiver.*
- Connect the equipment into an outlet on a circuit different from that to which the receiver is connected.*
- Consult the dealer or an experienced radio/TV technician for help.*



All pictures and illustrations shown in this user manual are indicatives and must be intended as support for installation instruction only. Actual product may vary due to product enhancement. Specifications subject to change without notice.

Product Manual

UNO-DM-6.0-TL-PLUS-US string inverters

1 - Introduction and general information



2 - Characteristics



3 - Safety and accident prevention



4 - Lifting and transport



5 - Installation



6 - Instruments



7 - Operation



8 - Maintenance



Introduction and general information

1

Warranty and conditions of sale

The terms and conditions of sale, including requirements for maintaining the warranty, are sent with each order. Refer to the terms and conditions when designing the site, installing the inverter and setting up a preventative maintenance program.

In particular, pay attention to physical clearances, any site noise limitations, maximum system input voltage, potential flammability hazards.

ABB accepts no liability for failure to comply with the instructions for correct installation and is not responsible for equipment it has not supplied.

Any modification, manipulation, or alteration of the hardware or software, voids the warranty.

ABB is not liable for defects or malfunctions arising from improper use of the equipment, failures or problems due to shipping damage or out-of-spec environmental conditions; lack of or incorrect preventative maintenance, tampering or repairs; use or installation by unqualified persons.

Table of Contents

Introduction and general information	4
Warranty and conditions of sale	4
Table of Contents	5
Scope and target audience	9
Purpose.....	9
Additional information and documentation	9
Operating and maintenance safety.....	9
Symbols and signs	10
Intended use	11
Limitations in intended use	11
Improper or prohibited use	11
Features	12
Introduction	12
Models and range of equipment	13
Identification of the equipment and manufacturer	14
Reference number index	16
Graphical representation of references	16
Accessory Board UNO-DM-COM KIT (optional)	17
Accessory Board UNO-DM-PLUS-Ethernet COM KIT (optional)	17
Technical data	18
Response to abnormal conditions	20
Grid support function.....	21
Torques	23
Outer dimensions.....	23
Bracket dimensions.....	24
Efficiency curves	25
Power limitation (Power Derating)	26
Power reduction due to environmental conditions.....	26
Characteristics of a photovoltaic generator	27
Strings and Arrays.....	27
Description of the inverter	28
Multiple-inverter system	28
Notes on system sizing	28
Inverter block diagram	28
PV plant block diagram	30
Operating diagram	30
Default functionality and components of the inverter	31
Functionalities available with accessory board	32
Safety devices	34
Anti-Islanding	34
Photovoltaic panel ground fault	34
Arc Fault Detection (AFD).....	34
Ground fault detection and interruption scheme	34
Other safeguards	35



Safety and accident prevention	36
Safety information and instructions	36
Signs and labels.....	36
Environmental conditions and risks	37
Thermal and electrical hazards.....	37
Clothing and protection of personnel.....	37
Residual risks	39
Table of residual risks	39
Lifting and transport	40
Transport and handling	40
Lifting.....	40
Unpacking and incoming inspection	40
Storage.....	41
Weights	41
Lifting.....	41
Packing list.....	42
Installation	43
Installation warnings	43
Installation site and position.....	44
Installation sites with high humidity	45
Wireless signal environmental checks.....	46
Recommendations for the wireless signal power	48
Wall mounting	49
Opening the front cover	50
Installation planning	51
AC overcurrent protection	51
Choice of grid output connection type (AC side)	51
Sizing the ground cable(s)	52
Sizing the AC cable.....	52
Clamps terminal use	53
Preliminary operations for connection of the PV generator	54
Independent or parallel input channels configuration.....	54
Channel configuration examples	55
Independent channel configuration (default configuration)	56
Parallel channel configuration	56
Checking the correct polarity of the strings	57
Checking of leakage to ground of the photovoltaic generator.....	57
Electrical connection to the PV field - DC side	58
Grid output connection (AC side)	60
Connection to AC terminal block.....	60
Grid standard setting of the country.....	61
Rapid Shutdown (RSD) connection	62
Communication and control signal connections to the accessory UNO-DM-COM KIT board ...	63
Description of terminal blocks on the UNO-DM-COM KIT board	64
Description of terminal blocks on the UNO-DM-PLUS-Ethernet COM KIT board	65
Connection of the RS485 line.....	66
Remote control connection	68
Demand Responce Mode 0 (Request by AS/NZS 4777).....	68
Configurable Relay connection (ALARM / LOAD MANAGER)	69
Closing the front cover	70



Instruments	71
Description of keyboard and LED Panel.....	72
Operation	73
Introduction and operation warnings	73
Monitoring and data transmission	74
User interface.....	74
Measurement tolerance	74
Commissioning (Via internal Webserver)	75
Commissioning (Using the inverter display)	83
Power, Alarm, GFI LEDs behavior	85
Specifications on operation of the LEDs.....	86
LED insulation fault	86
COMM Status, RSSI LEDs behavior	86
Description of the internal Webserver	87
Access to the internal Webserver	87
webserver menu structure	90
MAIN section.....	91
SETUP section.....	92
EVENTS Section.....	94
USER section.....	95
NETWORK section	96
TOOLS section.....	101
INFORMATION Section	110
Description of the Display menus	111
General information	111
Menu structure	112
System Menu	113
Inverter Menu	115
Display Menu	127
WLAN Logger Menu	128
Maintenance	129
Introduction and maintenance warnings	129
Routine maintenance	130
Troubleshooting	131
Internal Webserver and wireless communication troubleshooting.....	131
Inverter alarm codes	133
Power limitation messages	142
Dismantling the inverter	144
Calculation of second-level password (Service menu, Admin Plus)	145
Resetting the remaining time for grid standard variation from display	146
Verification of ground leakage	147
Behavior of a system without leakage	147
Behavior of a system with leakage	148
Measuring the insulation resistance of the PV generator.	149
Storage and dismantling	150
Storage of an uninstalled inverter for long periods.....	150
Storage of an installed inverter for long periods of non-use.....	150
Disposal.....	150



Attachments 151

- Port and network services used by the inverter** 151
 - IP Network Services 151
 - Network Hosts 152
 - Inverter network configuration 152
- Further information** 153
- Contact us** 154



Scope and target audience

Purpose

This product manual is a useful guide that will enable workers to safely operate the inverter and maintain it in good working order.



If the equipment is used in a manner not specified in this manual, the protection provided by the equipment may be compromised.



Additional information and documentation

In addition to this product manual, one may download additional product documentation, including the Auroral Manager software required for communicating with the inverter, by visiting www.abbsolarinverters.com.

The ABB solar inverter help desk may be reached at 1-877-261-1374, 6am - 6pm (PST) Monday-Friday, excluding major holidays.

Operating and maintenance safety













Personnel in charge of using and maintaining the inverter must be properly qualified and educated for the tasks, and must be able to read and correctly interpret this product manual.

The installation must be performed by qualified installers and/or licensed electricians, with experience in photovoltaic systems. Installation must be in accordance with the NEC and any other local electrical codes. The local electrical utility and/or authority having jurisdiction, AHJ, must approve any installation before it is connected to the electrical grid.

Anyone working on or around the photovoltaic system, especially the inverter, must choose and use appropriate personal protective equipment (PPE).

Symbols and signs

In the manual and/or in some cases on the equipment, the danger or hazard zones are indicated with signs, labels, symbols or icons.

Symbol	Description
	General warning - Important safety information. Indicates a potentially hazardous situation which, if not avoided, could result in death or serious injury.
	Dangerous Voltage - Indicates a potentially hazardous situation, in particular a high voltage, which, if not avoided, could result in death or serious injury. The inverter has high voltages and energy levels.
	Hot parts - Indicates a potentially hazardous situation, in particular a hot surface, which, if not avoided, could result in death or serious injury. Some surfaces in the inverter will become hot during operation and must not be touched until the parts have cooled down.
	Risk of injury due to the weight of the equipment. Take care during lifting and transport
	Indicates that it is mandatory to carry out the described operations using the clothing and/or personal protective equipment provided by the employer.
	System ground conductor connection point.
	Equipment Grounding Conductor (EGC) connection point.
	Rated temperature range.
	Direct current
	Alternating current
	Phase
	The DC input voltage positive terminal
	The DC input voltage negative terminal

Intended use

ABB is not be liable for any damage whatsoever that may result from incorrect or careless operation.

Do not use the inverter in a way for which is was not intended. The inverter MUST NOT be used by inexperienced staff, or even experienced staff if carrying out operations that fail to comply with the iinstuictions in this product manuals, or documentation shipped with the inverter.



The inverter is designed for transforming continuous electrical current (DC) supplied by photovoltaic array (PV) into alternating electrical current (AC) suitable for feeding to the public distribution grid.

Limitations in intended use

The inverter is designed for use with photovoltaic modules which have floating inputs.

Only photovoltaic modules may be connected to the inverter input. Do not connect batteries or other power supplies.

The inverter cannot be connected, on the DC side, in parallel to other inverters to convert energy from a photovoltaic array with power exceeding the nominal power of the single inverter.

The inverter may only be used in compliance with all its technical specifications.

Improper or prohibited use

DO NOT:

- *Install the inverter in environments subject to flammability or in adverse or disallowed environmental conditions, (temperature and humidity).*
- *Use the inverter with safety devices which are faulty or disabled.*
- *Use the inverter or part of it connected to other machines or equipment.*
- *Modify operating parameters that are not accessible to the operator, or modify the inverter to chance its performance or electrical isolation.*
- *Clean with corrosive products that could damage the inverter.*
- *Use or install the inverter or parts of it without having read and understood the contents of the product manual.*
- *Heat or dry rags, or clothing, on inverter. In addition to being hazardous, it would compromise component ventilation and cooling.*

Introduction

This chapter describes the features of the inverter, and identifies the principal components needed to understand the installation and operating instructions. Some terminology is defined. Technical datasheets, physical dimensions and safety ID plates are explained.

The customer/Installer takes full responsibility if, when reading this manual, it's not read in the proper order. All information assumes that that presented in previous chapters has been read and understood.

Models and range of equipment

For each model, the following variant is available:

- **Model with “SB-RA” suffix (e.g. UNO-DM-6.0-TL-PLUS-US-SB-RA).**

Meaning of the suffix SB-RA:

S = DC disconnecting switch .

B = Wireless communication

R = Rapid shutdown

A = ARC fault device



The choice of the inverter model must be made by a qualified technician who knows about the installation conditions, the devices that will be installed outside the inverter and possible integration with an existing system.

Identification of the equipment and manufacturer

The technical data provided in this manual does not substitute the data supplied on the labels affixed to the equipment.



The labels affixed to the equipment must NOT be removed, damaged, stained, hidden, etc., for any reason whatsoever.

The Regulatory label contains the following information:

1. Manufacturer
2. Model
3. Rating data
4. Certification marks



The labels are NOT to be hidden by foreign objects and parts (rags, boxes, equipment, etc.); they must be regularly cleaned and always kept in sight.

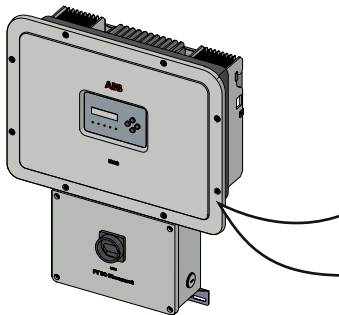





www.abb.com/solar

SOLAR GRID SUPPORT UTILITY INTERACTIVE TRANSFORMERLESS INVERTER

MODEL: UNO-DM-6.0-TL-PLUS-US-SE-RA



UL 1741



CSA C22.2 107.1

Country: Italy

AC RATING		
Rated Grid AC Voltage (Vacr)	208 V~ 1Ø	240 V~ 1Ø
Operating Voltage Range	183-228 V~	211-264 V~
Nominal Output Frequency	60 Hz (factory preset)	
Operating Frequency Range	50.0 (*) - 64.0 (‡) Hz	
Power Factor	>0.995 (‡)	
Nameplate Apparent Power (Smax)	6650 VA	
Nameplate Active Power (Pmax @cosφ= 1)	6000 W @ 45 °C amb.	
Rated Active Power (@Vacr, cosφ= ± 0.9)	5600 W	6000 W
cosφ Adjustability Range	0.1 - 1 (‡)	
Max. Output Current	30 A (rms)	
Max. Output Overcurrent Protection	40 A	

DC RATING		
Nominal Input Operating Voltage	340 V	355 V
Max. Input Voltage	600 V	
Range of Input Operating Voltage	90 - 580 V	
Range of Input Voltage @Full Power	160 - 480 V	
Max. Input Current - per channel	20 A	
Max. Input Short Circuit Current - per channel	24 A	

Operating Ambient Temperature: -25 to +60 °C (-13 to +140 °F), with Output Power Derating

Type of Enclosure: NEMA 4X

DC Ground Fault Detector/Interrupter is Provided Photovoltaic Arc-Fault Circuit Protection-Type1

(*) : Adjustable from 50.0 Hz to 59.9 Hz (‡) : Adjustable from 60.1 Hz to 64.0 Hz





(‡) : Adjustable from -0.8 to +0.8 @Smax

For more details about product specifications refer to the Instruction Manual

Contains FCC ID: X6W-V2P53

This device complies with Part 15 of the FCC Rules. Operation is subject to the following two conditions: (1) this device may not cause harmful interference, and (2) this device must accept any interference received, including interference that may cause undesired operation.

Besides the Regulatory label, an additional product label is also provided. The label displays the following information:

<p>ABB UNO-DM-X.X-TL-PLUS-US-XY-RA</p>     	<p>P/N: PXXXXXXXXX</p> <p>SN: YYWSSSSSS WK: WWYY</p> <p>WO: XXXXXXXX</p> <p>SO: SXXXXXXXXX Q1</p>	<ul style="list-style-type: none"> • Inverter model <ul style="list-style-type: none"> - X.X = Inverter power rating: - X = Integrated disconnect switch (-S) - Y = Integrated WLAN board (-B) • Inverter Part Number • Week/Year of manufacture • Inverter Serial Number consisting of: <ul style="list-style-type: none"> - YY = Year of manufacture - WW = Week of manufacture - SSSSSS = sequential number
---	---	--



An additional Wireless Identification label is provided. The label displays the following information:

<p>SN WLAN: SSSSSSSSSS</p> <p>PN WLAN: VKA.V2P53.1</p> <p>Mac Address: AA:BB:CC:DD:EE:FF</p> <p>----- Remove and apply on the Quick installation guide -----</p> <p>SN WLAN: SSSSSSSSSS</p> <p>SN Inverter: ZZZZ/ZZZZZ</p> <p>Mac Address: AA:BB:CC:DD:EE:FF</p> <p>PK: 0000-0000-0000-0000</p>	<ul style="list-style-type: none"> • WLAN board Serial Number • WLAN Board Part Number • WLAN Board MAC address: <ul style="list-style-type: none"> - To be used to obtain the SSID of the wireless access point created by the inverter: ABB-XX-XX-XX-XX-XX-XX (where "X" is a hex digit of the MAC address). - To be used to obtain the "Host Name": http://ABB-XX-XX-XX-XX-XX-XX.local (where "X" is a hex digit of the MAC address). - MAC address it's the only required information to register the inverter with Aurora Vision. • Inverter Serial Number • Product Key: <ul style="list-style-type: none"> To be used as wireless access point password, after 24 hours which the inverter is power on (then the default password "ABBSOLAR" is expired) or to be used to access to the internal webserver as username and password in case of lost credentials.
--	---



The Wireless Identification label is divided in two separate parts by a dashed line; take the bottom part and apply it on the cover page of the quick installation guide.



The officially required information is located on the Regulatory label. The product label or the Wireless Identification label are accessory labels which shows the information necessary for the identification and characterisation of the inverter by ABB.



Note: The labels are NOT to be hidden by foreign objects and parts (rags, boxes, equipment, etc.); they must be regularly cleaned and always kept in sight.

Reference number index

- | | | |
|----------------------------|--|--|
| 01, Bracket | 09, RSD terminal block | 16, DC disconnect switch |
| 02, Lock spring | 10, AC output terminal block | 18, Accessory boards |
| 03, Heat sink | 11, Wireless antenna | 19, Protective Earth (PE) connection point |
| 04, Inverter front cover | 12, DC Input terminal block | 20, Inverter |
| 05, Wiring box front cover | 13, 3/4" DC conduit opening (1" drill out marking) | 28, Wiring box |
| 06, LED panel | 14, 3/4" AC conduit opening | 29, Lower bracket |
| 07, Display | 15, 1/2" signal conduit drill out marking | |
| 08, Keyboard | | |



Graphical representation of references

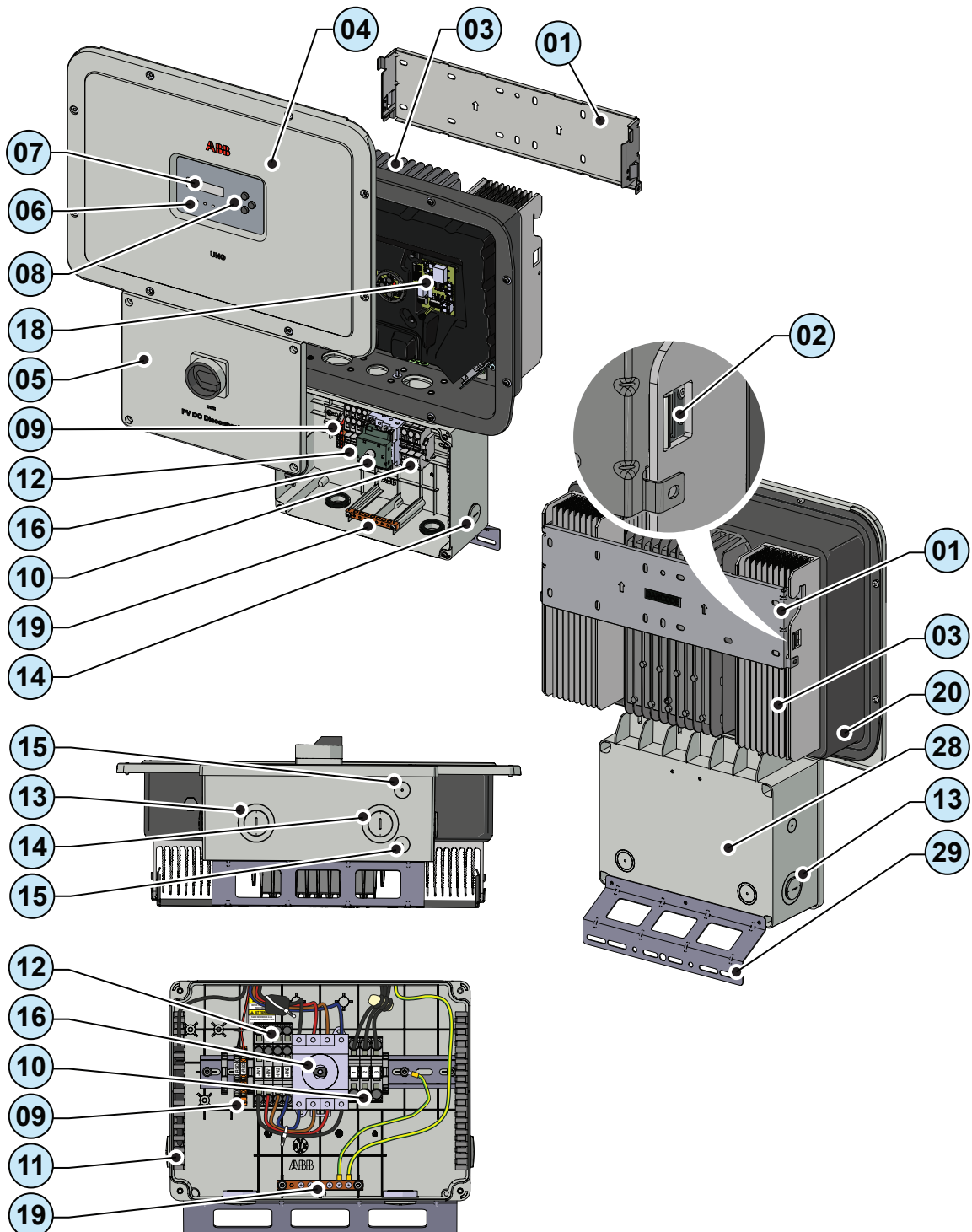

Accessory Board UNO-DM-COM KIT (optional)

The inverter can be equipped with advanced accessory board PN: UNO-DM-COM Kit (ordered separately), adding:

- An RS-485 serial interface
- Configurable relay:
- Remote switch-on/switch-off

- ⑱, UNO-DM-COM KIT
- ㉑, Inverter connector
- ㉒, RS485 Termination line jumper
- ㉓, DRM0 activation jumper
- ㉔, ALARM terminal block
- ㉕, Fixing point
- ㉖, RS485 and REM terminal block

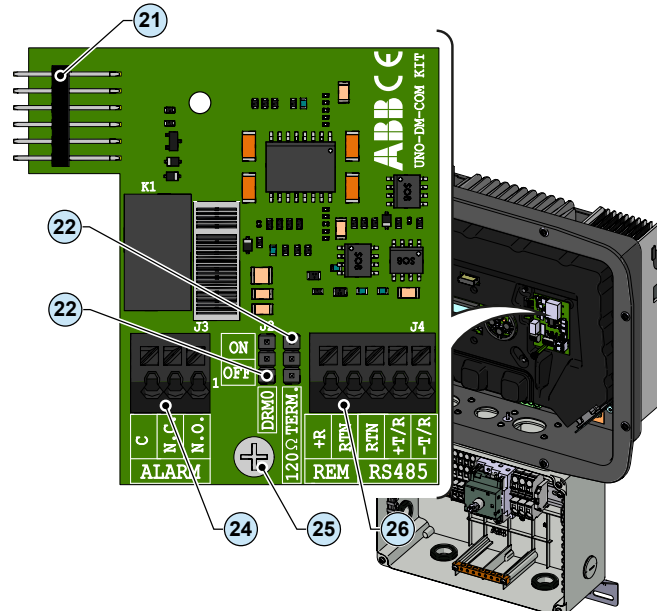

Accessory Board UNO-DM-PLUS-Ethernet COM KIT (optional)

The inverter can be equipped with advanced accessory board PN: UNO-DM-PLUS-Ethernet COM KIT (ordered separately), adding:

- An RS-485 serial interface and the Ethernet communication interface
- Configurable relay:
- Remote switch-on/switch-off

- ⑱, UNO-DM-PLUS-Ethernet COM KIT
- ㉑, Inverter connector
- ㉒, RS485 Termination line jumper
- ㉓, DRM0 activation jumper
- ㉔, ALARM terminal block
- ㉕, Fixing point
- ㉖, RS485 and REM terminal block
- ㉗, LAN Ethernet connector

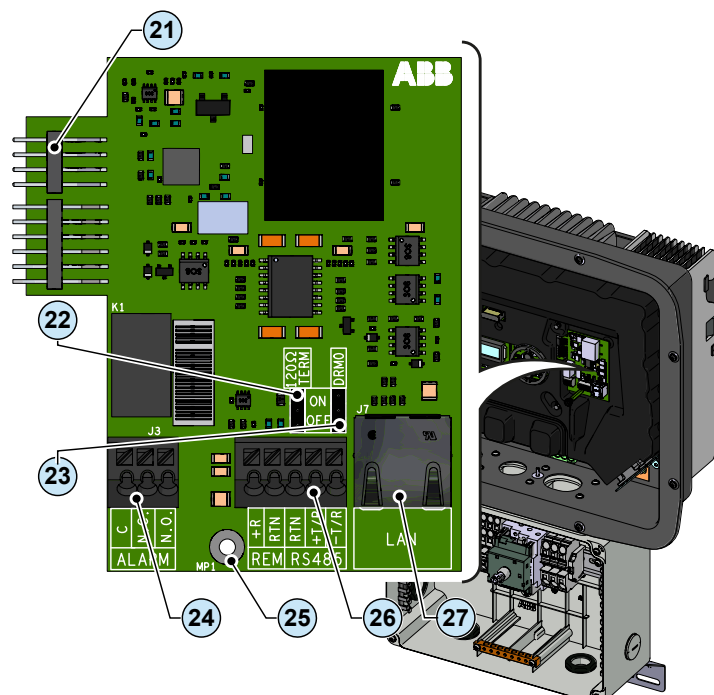

Technical data

UNO-DM-6.0-PLUS-US

Input side (DC)	
Absolute maximum voltage ($V_{max,abs}$)	600 V
Start-up voltage (V_{start})	default 200 V (120...350 V)
Operating MPPT voltage range ($V_{dcmin}...V_{dcmax}$)	0.7x V_{start} ...580 V ($\geq 90V$)
Maximum usable power ($P_{dcrMPPT}$) - each channel	4000 W
Number of independent MPPT channels	2
Full power MPPT voltage range ($V_{MPPTmin} ... V_{MPPTmax}$) with parallel MPPT configuration a P_{acr}	160...480 V
Maximum usable current ($I_{dc,max}$) - each channel	20.0 A
Maximum current ($I_{dc,max}$)	40.0 A
Maximum short circuit current ($I_{sc,max}$) - each channel	24 A
Number of wire landing terminals	2 pairs, capable of connecting two parallel strings
Array wiring termination	Terminal block, pressure clamp, AWG20-8
Input protection	
Reverse Polarity Protection	Yes, from current limited source
Over-voltage protection type	Varistor
PV array ground fault detection	Pre start-up RISO and dynamic GFDI
DC switch rating	32A@600V
Output side (AC)	
AC grid connection type	1 Φ /2W or Split- Φ /3W
Nameplate Apparent Power (S_{max})	6200 VA (208 Vac) 6650 VA (240 Vac)
Nameplate Output Active Power ($P_{max@cos\phi=1}$)	6000 W (208 Vac) 6000 W (240 Vac)
Output Active Power @ V_{acr} and $cos\phi=\pm 0,9$ (P_{Rated})	5600 W (208 Vac) 6000 W (240 Vac)
Nominal AC output voltage (V_{acr})	208Vac (1 Φ /2W) or 240Vac (Split- Φ /3W)
Adjustable voltage range ($V_{acmin}...V_{acmax}$)	183...228 Vac (1 Φ /2W) or 211...264 Vac (Split- Φ /3W)
Maximum current ($I_{ac,max}$)	30 A
Contributory fault current	40.0 A
Grid frequency (f_r)	60 Hz
Adjustable grid frequency range ($f_{min}...f_{max}$)	50...64 Hz
Power factor and adjustability range	>0.995, adj. +/-0.8
Total harmonic distortion at rated power	<2%
Grid wiring termination type	Terminal block, pressure clamp, AWG20-6
Output Protection	
Anti-islanding protection	Meets UL1741 / IEEE1547 requirements
Over-voltage protection type	Varistor, 2 (L1 - L2 / L1 - G)
Maximum AC OCPD rating	40.0 A
Operating Performance	
Maximum efficiency (η_{max})	97.4%
CEC efficiency	96.5% (208 Vac) 97.0% (240 Vac)
Stand-by consumption	8.0 Wrms
Night-time consumption	< 0.6 Wrms
Auxiliary Output	
Isolated Auxiliary Power Supply ⁽¹⁾	24Vdc, 0.4A max
Embedded Communication	
Embedded Communication interface	Wireless ⁽²⁾
Embedded Communication Protocol	ModBus TCP (SunSpec)
Commissioning Tool	Web User interface, Display, Aurora Manger Lite
Monitoring	Plant Portfolio Manager, Plant Viewer, Plant Viewer for Mobile

UNO-DM-6.0-PLUS-US

Optional board UNO-DM-COM Kit

Optional Communication Interface	RS485, Alarm/Load manager relay, Remote ON/OFF
Optional Communication Protocol	ModBus RTU (SunSpec), Aurora Protocol

Optional board UNO-DM-PLUS-Ethernet COM Kit

Optional Communication Interface	Ethernet, RS485, Alarm/Load manager relay, Remote ON/OFF
Optional Communication Protocol	ModBus TCP (SunSpec), ModBus RTU (SunSpec), Aurora Protocol

Environmental

Ambient air operating temperature range	-13°F to +140°F (-25°C to +60°C) derating above 113°F (45°C)
Relative Humidity	5-100% RH condensing
Acoustic noise emission level	< 50 db (A) @1m ⁽⁴⁾
Maximum operating altitude without derating	6560ft (2000m)
Environmental class	Outdoor

Mechanical specifications

Enclosure rating	Certified to NEMA Type 4X
Cooling system	Natural convection
Dimensions (H x W x D)	28.7 x 21.8 x 7.1in (728 x 553 x 180mm) ⁽³⁾
Weight	47.4lb (21.5kg) ⁽³⁾
Mounting system	Wall bracket
Conduit connections ⁽²⁾	Bottom: Markings for (2) concentric KOs 1", 3/4" and (2) KOs 1/2" Sides: Markings for concentric KOs 1", 3/4" ⁽³⁾

Safety

Insulation level	Transformerless (floating array)
Safety and EMC standard	UL1741, IEEE1547.1, CSA-C22.2 N. 107.1-01, UL1998 UL 1699B, FCC Part 15 Class B
Grid standard	UL 1741 SA, IEEE 1547, Rule 21, Rule 14 (HI)
Safety approval	cTUVus

1. The auxiliary output is used to supply the RSD contactors when required
2. WLAN IEEE 802.11 b/g/n @2,4GHz
3. When equipped with DC switch and wiring box
4. @ Pure sine wave condition.

Note. Features not specifically listed in the present data sheet are not included in the product



Response to abnormal conditions

Abnormal grid conditions

The inverter is programmed to respond to abnormal grid conditions, as specified in the below table:

Condition	Utility Source		Max. time (sec) ² at 60Hz before cessation of current
	Voltage (V)	Frequency (Hz)	
A	$<0.50 V_{nom}^1$	Rated (60Hz)	Default setting ³ 0.16 (Adj. 0.16 to 1.5)
B	$0.50 V_{nom}^1 \leq V < 0.70$	Rated (60Hz)	Default setting ³ 3 (Adj. 0.16 to 30)
C	$0.70 V_{nom}^1 \leq V < 0.88$	Rated (60Hz)	Default setting ³ 2 (Adj. 0.16 to 30)
C	$1.10 V_{nom}^1 < (*)$	Rated (60Hz)	Default setting ³ 1 (Adj. 0.16 to 30) (*)
D	$1.20 V_{nom}^1 \leq V (*)$	Rated (60Hz)	Default setting ³ 0.16 (Adj. 0.001 to 0.16 sec)
E	Rated	Default setting ³ $f > 60.5 \text{ Hz}$ (Adj. 60.1 to 64.0 Hz)	Default setting ³ 0.16 (Adj. 0.16 to 300 sec)
F	Rated	Default setting ³ $f < 59.3 \text{ Hz}$ (Adj. 56.0 to 59.9 Hz)	Default setting ³ 0.16 (Adj. 0.16 to 300 sec)
G	Rated	Default setting ³ $f < 57.0 \text{ Hz}$ (Adj. 50.0 to 56.0 Hz)	0.16 (Fixed)
H	Rated	Default setting ³ $f > 63.0 \text{ Hz}$ (Adj. 62.0 to 64.0 Hz)	0.16 (Fixed)

1. V_{nom} is the nominal output voltage rating.

2. Trip limit and trip time accuracy specification is as follows: Voltage: +/-2%, Frequency: +/- 0.10Hz, Time: 2 grid cycles (33ms @ 60Hz).

3. Default settings aligned with IEEE 1547-2003 requirements.

To adjust voltage and frequency and disconnect times to meet local utility requirements, make modifications are made using:

- The inverter embedded web user interface. The Admin password is required to unlock the "installer" functionalities.
- The LCD display. A time-limited service password is required, contact ABB solar inverter technical support 1-877-261-1374.
- Aurora Manager LITE software. Connect the inverter equipped with UNO-DM-COM kit UNO or UNO-DM-PLUS-Ethernet COM kit to a PC through a RS-485/USB adapter. Download the manual at www.abb.com/solarinverters. An User ID and a password is required to unlock the "installer" functionalities of the software, contact ABB solar inverter technical support 1-877-261-1374.

Fault currents and durations

During a grid fault including a short circuit condition, the inverter may inject current into the grid as specified below:

Utility voltage (V)	Fault current RMS (A)		
	1 cycle	3 cycle	5 cycle
208	17.4	15.9	15.8
240	17.1	16.5	16.0

Output power derating at high ambient temperature

Under high ambient temperatures, the inverter is designed to automatically reduce its output power. Detailed derating curves by model are provided in the product manual found on www.abb.com/solarinverters.

Grid support function

The inverter is equipped with advanced grid support functionality that is useful to support reactive loads and also assist in reliable operation of the utility grid in the presence of a large number of distributed energy generation sources. This section provides an overview of the available grid support functions.

The parameters related to the grid support functions that are in this inverter can be modified by:

- Accessing the embedded Web User Interface.
- Accessing to settings under the Service menu requires a time-limited password, which can be obtained by calling ABB solar inverter technical support at 1-877-261-1374.



1. Voltage ride-through

This inverter provides parameters to respond to undervoltage and overvoltage events. The inverter is designed to operate normally within the specified operating range. If voltage excursions occur, the inverter is designed to continue operating normally or cease to export power for a specified delay. After this programmed delay, the inverter disconnects from the grid if the voltage is still out of its normal range. The voltage ride-through parameters can be adjusted.

2. Frequency ride-through

This inverter provides parameters to respond to underfrequency and overfrequency events. If frequency excursions occur, the inverter is designed to continue operating normally for a specified delay. Beyond this programmed delay, the inverter disconnects from the grid in the event of an abnormal voltage condition. The frequency ride-through parameters can be adjusted.

3. Reactive power modes

This inverter is designed to export active as well as reactive power into the utility grid. The inverter provides several modes of operation for reactive power control and are described below:

- Disable: This is the default setting. Under this setting, the inverter exports with a power factor of 1.0.
- Fixed power factor control (Fixed cos-phi): In this mode, the operator can set the output power factor to a fixed value. When enabled, Set percentage will appear on the display, allowing the setting of the value of Cos-Phi as a percentage from 0.1 to 100.
- Power factor as function of output power (Std cosphi 0.9): In this mode, the inverter reduces the output power as a function of the output power at a given operating point.
- Dynamic Volt/VAR control (Std Q(U)): In this mode, the level of reactive power exported by the inverter is a function of the operating grid voltage, also known as a Volt/VAR curve.

4. Power reduction

This inverter has two modes for active power reduction:

- Power limitation: When enabled, this mode limits the active power that the inverter can export to the grid. The setting is specified as a percentage of the rated power of the inverter, from 0% to 100% in steps of 1%.
- Frequency/Watt function (Set F Derating): In this mode, the inverter limits the active power as a function of the grid frequency. The default frequency/watt can be adjusted.

5. Ramp controls

The inverter is designed to control the rate at which output power is increased, either at startup, or after a temporary low power condition on the PV array (such as fast shading). The following ramp controls are provided on this inverter.

- Normal ramp: The normal ramp defines the maximum rate at which the inverter can increase the output power under normal operation. The normal ramp control limits the dramatic fluctuations in the output power in order to prevent instabilities on the utility grid. The normal ramp rate can be adjusted.
- Slow ramp: The soft-start ramp defines the maximum rate at which the inverter can increase the output power when the inverter is first starting up. This startup may occur on a daily basis or when the inverter restarts after an abnormal grid event has ended.



Refer to the dedicated application note “Grid Support Function - Application Guideline” in the ABB Solar website for more details about the grid support functions.

Torques

To maintain the NEMA 4X rating of the inverter and for correct installation, the following torques must be used:

Front cover fastening screws ⑤	2.5Nm (1.8 ft-lb)
Screw for Protective Earth (PE) connection point ⑱	2.0Nm (1.5 ft-lb)

Outer dimensions

The outer dimensions (inches) include the wall installation bracket.

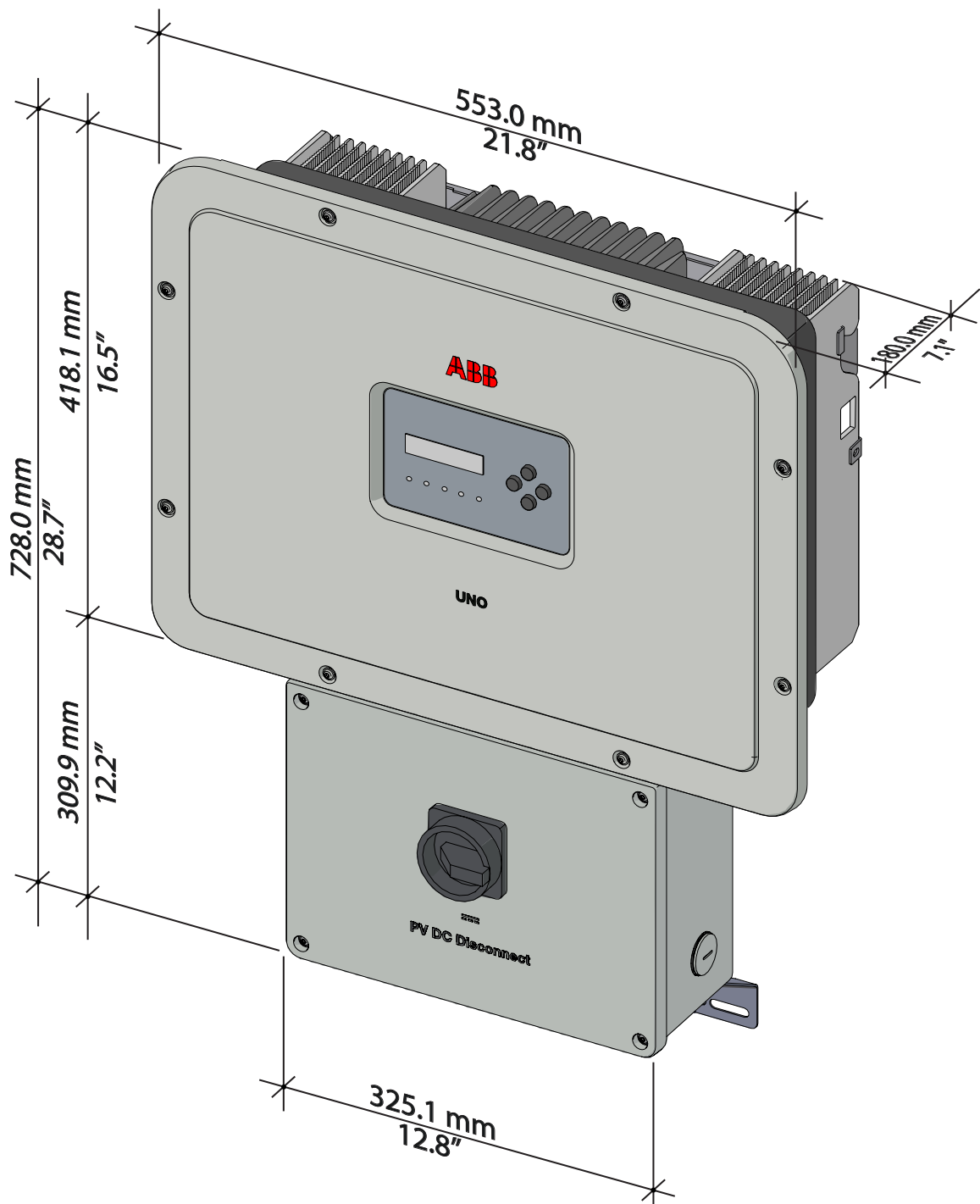

Bracket dimensions

The dimensions of the wall mounting bracket are expressed in inch.

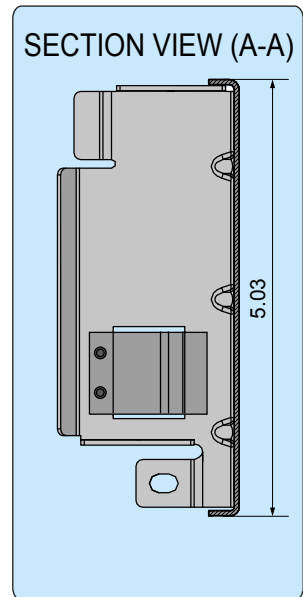
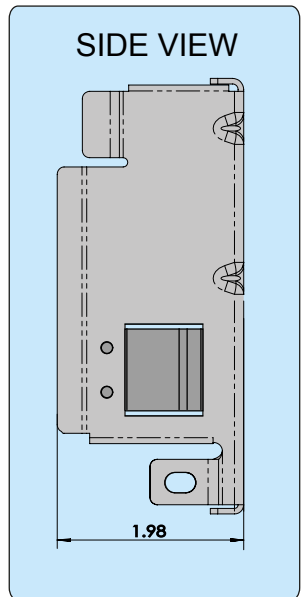
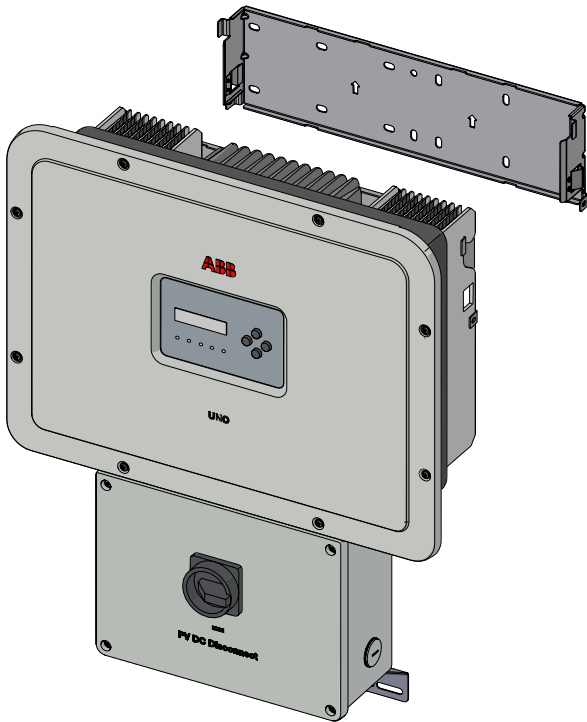
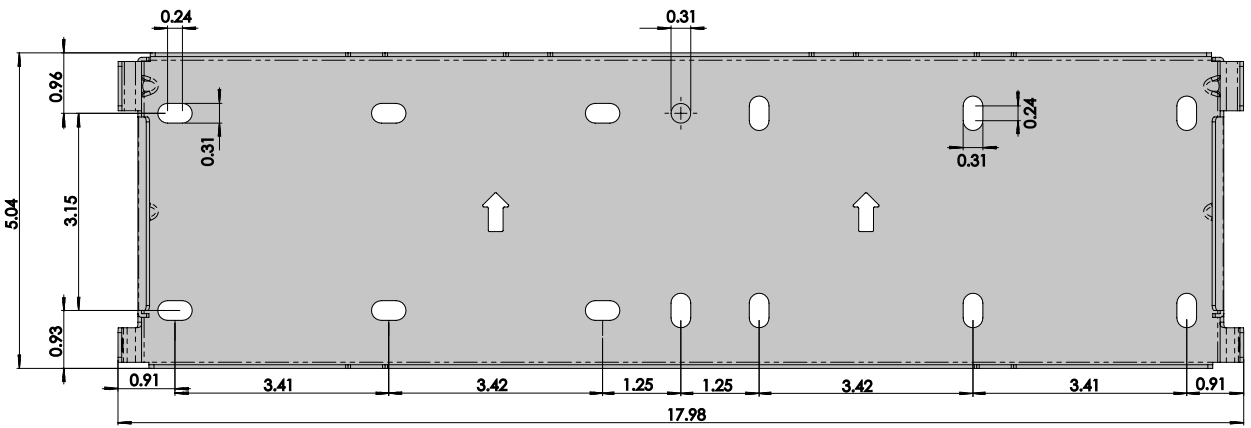
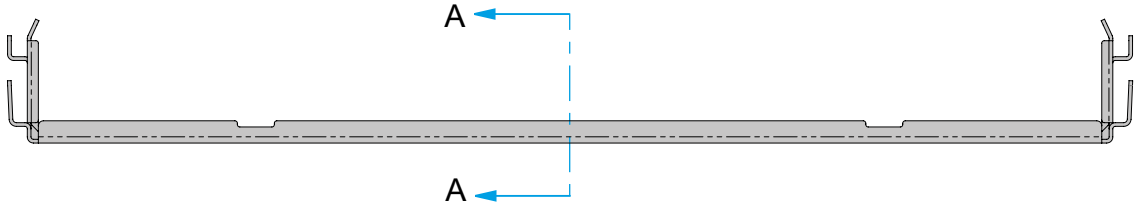

Efficiency curves

The equipment was designed considering current energy conservation standards, to avoid waste and unnecessary leakage.

Graphs of the efficiency curves of all models of inverter described in this manual are shown below.



The efficiency curves are linked to technical parameters that are continually being developed and improved and should therefore be considered approximate.

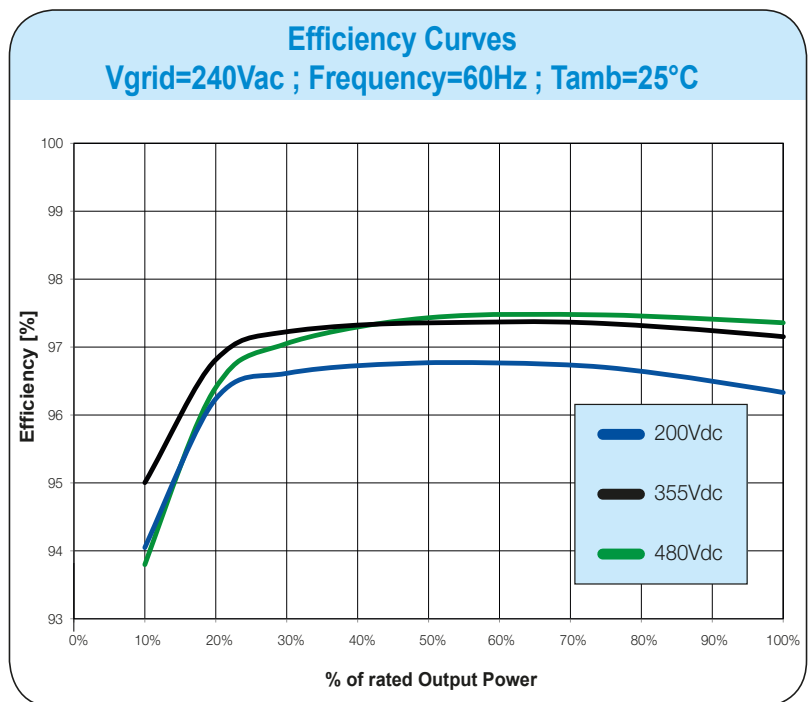
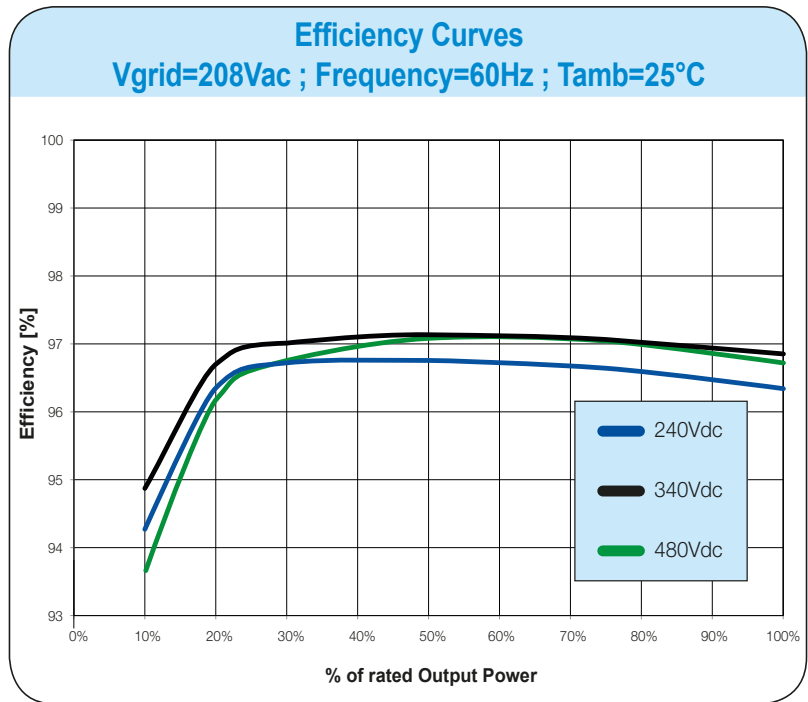

Power limitation (Power Derating)

In order to allow inverter operation in safe thermal and electrical conditions, the unit automatically reduces the value of the power fed into the grid.

Power limiting may occur due to:

- Adverse environmental conditions (thermal derating)
- Percentage of output power (value set by the user)
- Grid voltage over frequency (mode set by user)
- Grid overvoltage $U > 10\text{min Der.}$ (enabling carried out by user)
- Anti-islanding
- High input voltage values
- High input current values.

Power reduction due to environmental conditions

The power reduction value and the inverter temperature at which it occurs depend on the ambient temperature and on many operating parameters. Example: input voltage, grid voltage and power available from the photovoltaic field.

The inverter can therefore reduce the power during certain periods of the day according to the value of these parameters.

In any case, the inverter guarantees the maximum output power even at high temperatures, provided the sun is not shining directly on it.

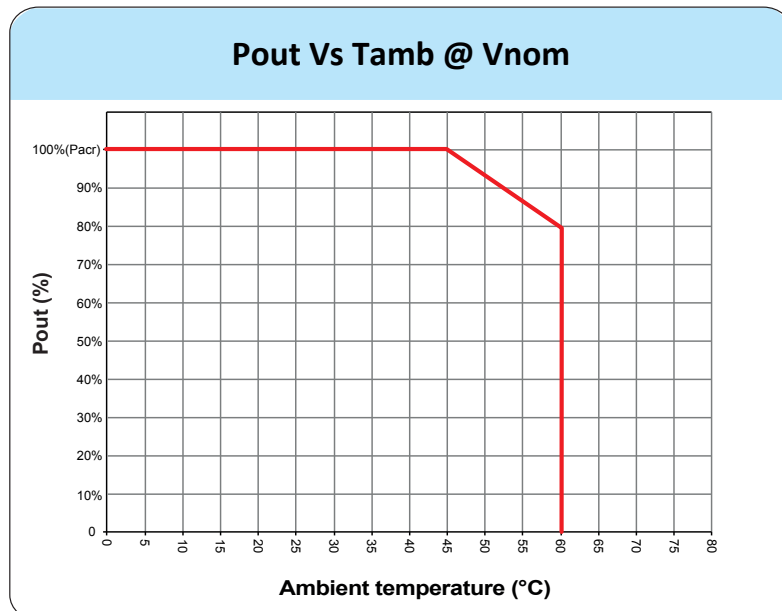

Characteristics of a photovoltaic generator

A PV generator consists of an assembly of photovoltaic modules that transform solar radiation into DC electrical energy and can be made up of:

Strings: number (X) of PV modules connected in series

Array: group of X strings connected in parallel

Strings and Arrays



The string technology was developed to significantly reduce the installation costs of a photovoltaic system, mainly associated to wiring on the DC side of the inverter and subsequent distribution on the AC side. A photovoltaic panel consists of many photovoltaic cells mounted on the same support.

- A string consists of a certain number of panels connected in series.
- An array consists of two or more strings connected in parallel.

Large photovoltaic systems can include multiple arrays connected to one or more inverters.

The greater the number of panels in each string, the lower the cost and the less complex the wiring connections of the system.

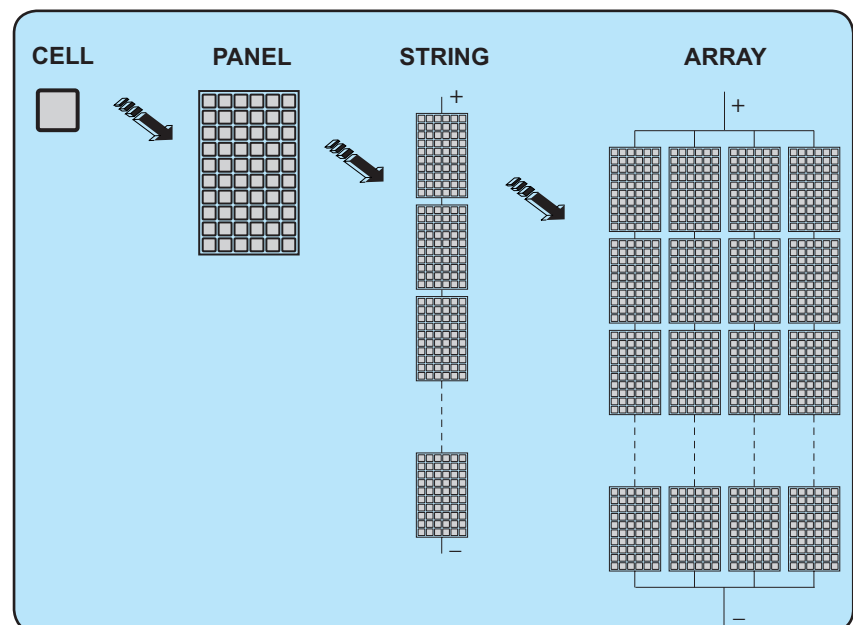

The current of each array must fall within the limits of the inverter.

Description of the inverter

This string inverter converts the direct current from a single PV array into alternating current, and feeds it into the electrical distribution grid.

This conversion, known as inversion from DC to AC, is done in efficiently, and electronically, without rotating machinery.

When connected in parallel with the grid, the alternating current from the inverter flows directly into a domestic or industrial distribution circuit, which is in turn connected to the public distribution grid.

The inverter automatically reduces the power fed into the grid under adverse environmental conditions, such as high temperature, unsuitable input voltages or grid instability.



Multiple-inverter system

Multiple inverters may be used at large-capacity sites. Each inverter must have its own individual PV array input, and on the AC side, and its own AC disconnect to the grid.

Each inverter will work independently from the others and will supply the grid with the maximum power available from its section of photovoltaic panels.

Notes on system sizing

Decisions on how to design a photovoltaic system depend on a number of factors, such as the type of panels, the space available, the location of the system, energy production goals, choice of inverter, etc.

A setup program to help correctly size the photovoltaic system is available on the ABB website (<http://stringsizer.abb.com>).

Inverter block diagram

The diagram shows the internal structure of the inverter. It has two stages:

- DC/DC input converter (boost)
- DC-AC output inverter

The DC-DC converter and the DC-AC inverter work at high switching frequencies, and are small and relatively light.

The converter input has maximum power point tracking (MPPT) to optimize energy production.

The inverter has no internal isolation transformer (no galvanic insulation between input and output), which reduces weight and increases efficiency. It has all protection necessary for safe operation and compliance with safety standards.

The inverter's operation and management of its protection features are controlled by two independent digital signal processors (DSP) and a central microprocessor. The connection to the grid is thus controlled by two independent computers, in full compliance with requirements for connection to the grid, and for safe and secure operation.

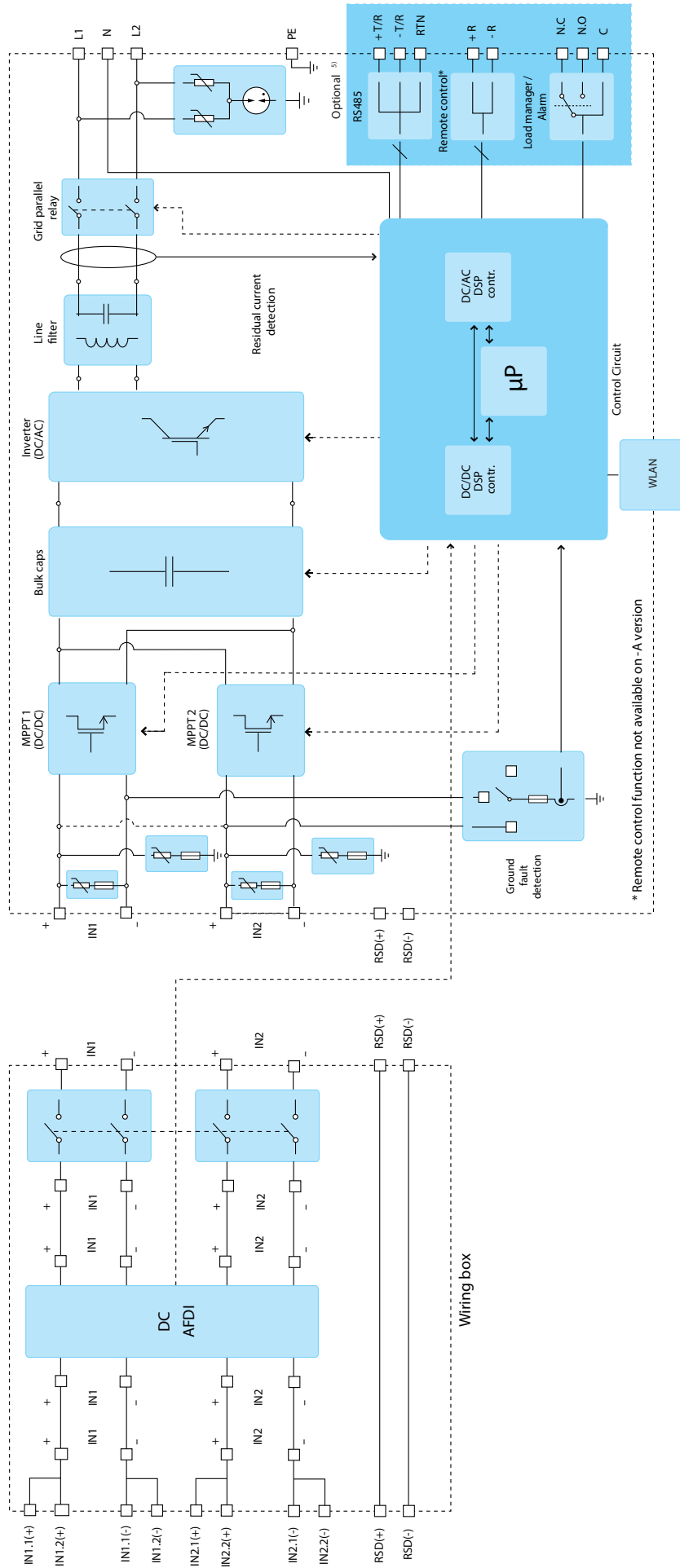

PV plant block diagram

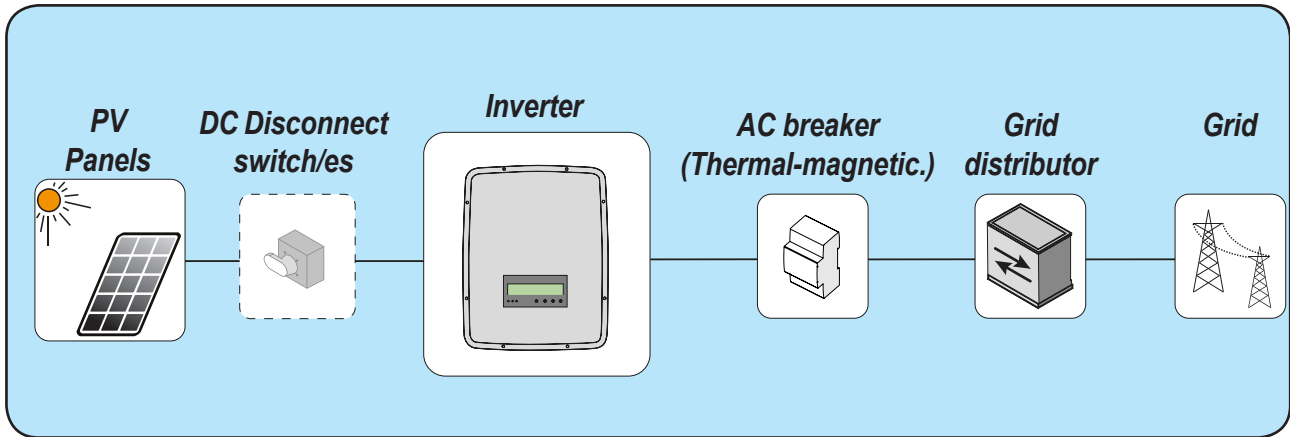

Operating diagram

The plant diagram shows how the integrated WLAN board allows the inverter to connect to a LAN local network using a wireless connection. The WLAN board features an advanced integrated webserver that enables to establish a direct connection to a PC, smartphone or tablet, allowing for inverter setup and local monitoring of the inverter.

When the inverter is connected to the WLAN network with access to the Internet, the device allows data to be transferred to the Aurora Vision® CLOUD platform for Internet monitoring using the Plant Portfolio Manager / Plant Viewer / Plant Viewer for Mobile (Mobile App).

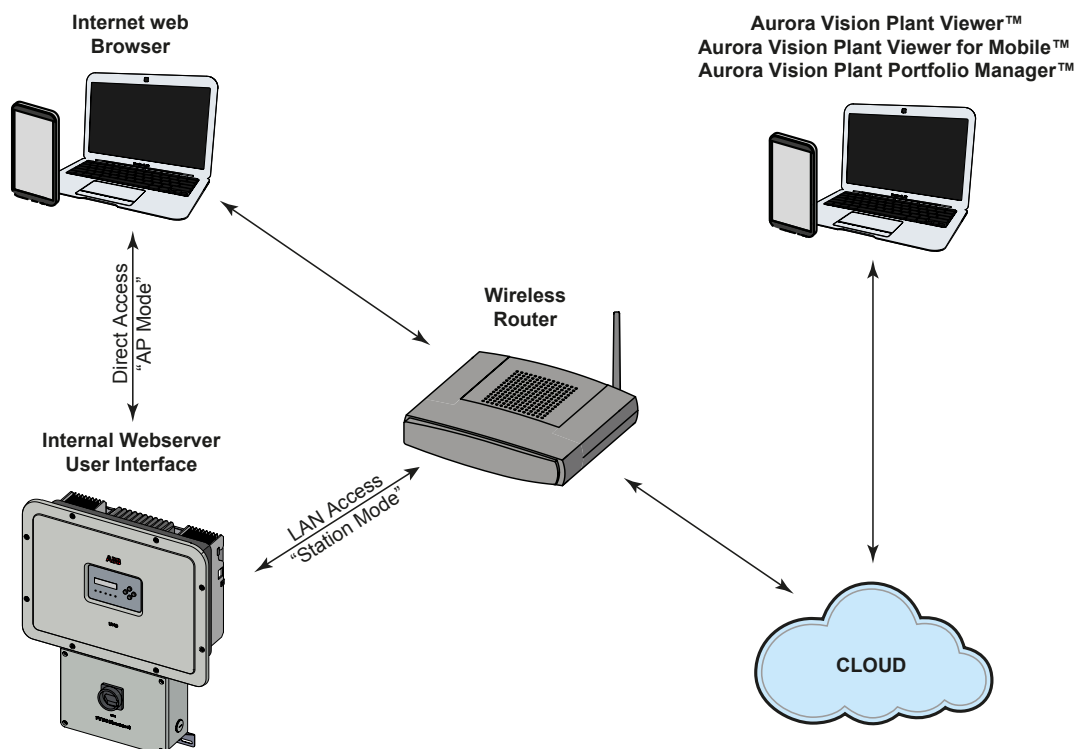

Default functionality and components of the inverter

- Advanced internal webserver

The UNO-DM-TL-PLUS inverters are equipped with a WLAN board IEEE802.11 b/g/n and with an internal webserver that allow commissioning of the system, a full access to all main configuration and parameters of the inverter and can act as local monitoring solution. It can be accessed by using from any wireless capable device like laptop, tablet or smartphone via a common browser.



- Aurora Vision Plant Management Platform

Aurora Vision is a cloud based platform enabling remote monitoring and asset management of ABB devices in range of solar power application.

Aurora Vision consists of a three different product:

1. **Plant Portfolio Manager** is a full featured web based application used by solar power professionals to monitor and manage a portfolio of solar power plants using ABB inverters.
2. **Plant Viewer** is an easy to use web based serviced application used by non-solar power professionals (such as homeowners or small business owners) to monitor solar power plants they own.
3. **Plant Viewer for Mobile** is the mobile version of **Plant Viewer** enabling non-solar power professionals to remotely monitor their own PV plants by using smart phones, tablets and iPod Touch with IOS and Android operating systems.

All three product previously mentioned work together to allow solar power professional and site owners to collaboratively manage solar power plant.

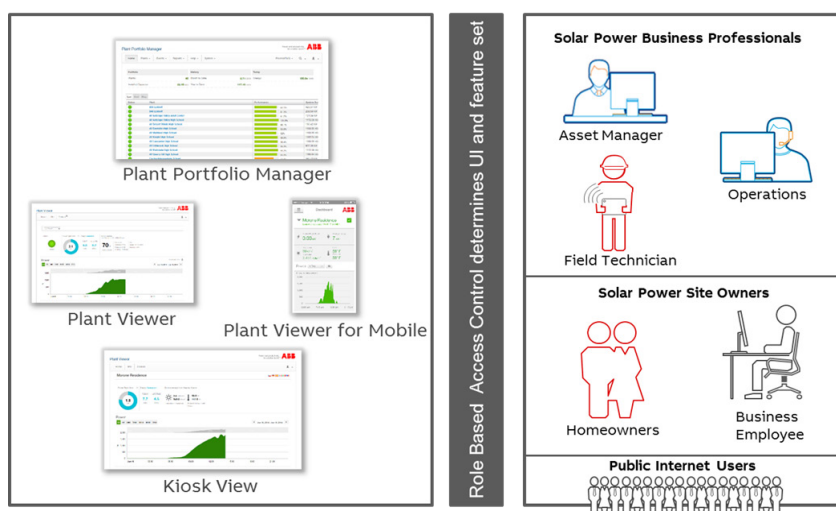

Please contact the ABB technical support for getting your own plant portfolio manager account (mainly for installers and plant administrators). Please get your Plant Viewer and Plant Viewer for Mobile by accessing the website www.auroravision.net and click on "Register with Plant Viewer" button (mainly for site owners).



- Remote Firmware Update Function

The inverter firmware can be updated remotely using the internal web-server dedicated section.

- Reactive power feed into the grid

The inverter is able to produce reactive power and can feed this power into the grid via the phase factor setting. Managing the feed can be set by the internal webserver, the display or through the configuration software (Aurora Manager Lite).

Power feeding modes vary according to the country of installation and the grid companies. For detailed information on the parameters and characteristics of this function, contact **ABB** directly.

- Limiting the active power fed into the grid

The inverter, if enabled and set using the display or the Aurora Manager configuration software, can limit the amount of active power fed into the grid by the inverter to the desired value (expressed as a percentage).

- Rapid shutdown (RSD) power supply

The inverter has 24Vdc (0.4A max) power supply on a spring-loaded terminal block inside the wiring box, which is designed to be used to power-up a RSD device.

Functionalities available with accessory board

The inverter can be equipped with advanced accessory board (UNO-DM-COM KIT or UNO-DM-PLUS-Ethernet COM KIT) adding either:

- An RS-485 serial interface or the Ethernet communication interface enabling the inverter to be used in one of the following operating mode:

Modbus Sunspec certified interface:

Thanks to the Modbus RTU/TCP communication protocol (Sunspec compliant), the inverter can be easily integrated with third party monitoring and control system by using the accessory board (UNO-DM-COM KIT or UNO-DM-PLUS-Ethernet COM KIT).



Please contact the ABB technical support or get access to Sunspec alliance website for getting the Modbus register map supported by the inverter.

- Configurable relay:

The advanced accessory board provides also a configurable switching relay, which can be used in different operating configurations that can be set in the dedicated menu.

A typical example of application is the activation of the relay in the event of an alarm.

- Remote switch-on/switch-off

This command can be used to switch off/switch on the inverter via an external (remote) command.

This function must be enabled in the menu and when active, switching on the inverter, besides being dictated by the presence of normal parameters which allow the inverter to be connected to the grid, also depends on the external command for switching on/off.



Safety devices

Anti-Islanding

In the event of a local utility company grid outage, or when the equipment is switched off for maintenance, the inverter must be physically disconnected to ensure protection of people working on the grid, all in accordance with the relevant national standards and laws. To prevent possible islanding (the condition in which a distributed generator continues to power a location even though electrical grid power from the electric utility is no longer present), the inverter is equipped with an automatic disconnection system called an Anti-islanding system.



Photovoltaic panel ground fault

This inverter must be used with photovoltaic modules connected with “floating” connections -- that is with positive and negative terminals that are not grounded. An advanced ground fault protection circuit continuously monitors the ground connection and disconnects the inverter when a ground fault is detected. The ground fault condition is indicated by a red LED on the front panel.

Arc Fault Detection (AFD)

This safety function allows the inverter to recognize series electrical arcing on DC cables. If arcing is detected, the inverter turns itself OFF, disconnects from the grid, and remains disconnected until manually reset. An AFD fault is reset by pressing the button on the left side of the DC wiring box, but a thorough check of the DC cables and panels must be completed first, to locate the source of the arcs. The AFD circuitry runs a self-test at each power up.

Ground fault detection and interruption scheme

As required by UL1741 CRD 2010, the inverter incorporates two separate methods for detecting a ground fault in the ungrounded PV array. These are described below:

Method 1: Pre-Start (Static RISO)

Any time conditions are suitable for the inverter to be connected to the grid, internal circuitry measures the insulation resistance (RISO) of the PV array conductors to ground. If the result of this static insulation resistance test is less than the pre-programmed threshold, the connection is aborted, the inverter will show an error, and illuminate the red LED GF indicator on the inverter's front panel. This test is conducted prior to any attempt to connect to the grid; e.g., at daybreak and any other time during the day where the inverter has been disconnected from the grid.

Method 2: Post Grid Connection (Dynamic Leakage Current)

While the inverter is connected to the grid, the inverter circuitry continuously checks for ground fault conditions using a differential measurement of the AC line, searching for any values that would indicate leakage of current to ground. Measurement of the ground leakage current is carried out simultaneously by two independent and redundant processors. If either processor detects an unacceptable value as defined below, the inverter will immediately be disconnected from the grid, and it will illuminate the red LED GF indicator on the inverter front panel.

The inverter responds differently depending on the level and duration of leakage current detected. If any of the following conditions is detected in measured values of differential current (IDIF) or a rapid change of IDIF over time ($\Delta\text{IDIF}/\Delta t$), the inverter will automatically disconnect from the grid and the red front panel GF LED will illuminate:

- If $\text{IDIF} > 300 \text{ mA}$ for a period of 300 msec
- If $\Delta\text{IDIF}/\Delta t > 30 \text{ mA/sec}$ for a duration of 300 msec
- If $\Delta\text{IDIF}/\Delta t > 60 \text{ mA/sec}$ with duration of 150 msec
- If $\Delta\text{IDIF}/\Delta t > 150 \text{ mA/sec}$ with duration of 40 msec

As a further safety precaution, in compliance with UL1741 CRD 2010, the inverter conducts an isolation monitor interrupter self-test before connecting to the grid, or every 24 hours, whichever is sooner. This test confirms that the circuitry needed to perform the isolation test is operating normally, and has not been damaged.

Ground fault errors are permitted to occur up to four times within a 24-hour period, after which a fifth ground fault error within a 24 hour period requires a manual reset. The system must be given a thorough examination before the reset, the cause of the ground fault located and corrected. This is intended to ensure equipment with a ground fault is not connected to the grid.

Other safeguards

The inverter also has:

- Constant monitoring of the grid voltage to ensure the voltage and frequency remain within operating limits;
- Internal temperature control to automatically limit the power (if necessary) to prevent overheating.

The numerous control systems and redundancy ensure safe operation.



Safety information and instructions

ABB accepts no liability for failure to comply with the instructions for correct installation. ABB is not responsible for equipment upstream or downstream from the inverter. .

It is essential to provide installers, operators and maintenance personnel with correct information. They must therefore read and comply with the information and instructions in the product manual.

The instructions provided in the product manual do not replace the safety devices and operation labels on the product, and they do not replace the safety regulations in force in the country of installation.



Do not use the PV system if any operating anomalies are identified. .

All repairs must be completed by trained ABB authorized service personnel, using ABB-approved components.

Signs and labels

The labels on the equipment must NOT be removed, damaged, defaced, hidden, etc.

The labels must be regularly cleaned and kept in sight, i.e. NOT hidden by foreign objects and parts (rags, boxes, equipment, etc.)

The technical data provided in this manual does not in any case replace that shown on the labels affixed on the equipment.

Environmental conditions and risks

The inverter is designed to be installed outdoors, in environmental conditions meets ambient temperature, air circulation and other specifications.



Do not install the inverter in a flammable or explosive environment.

Operator must be properly trained and qualified personnel to come into close proximity to the equipment, and highlight, with notices or other means where necessary, the hazardous areas or operations at risk: magnetic fields, hazardous voltages, high temperatures, possible discharges, generic hazard, etc.

Thermal and electrical hazards

Do not remove covers until voltage has been completely removed from the inverter. Follow guide for voltage discharge and component cool off time.

When the device has just been switched off, it may have hot parts as a result of overheating of the heated surfaces (e.g.: transformers, accumulators, coils, etc.) so be careful where you touch.

Clothing and protection of personnel

NFPA standards (which OSHA recommends and consults) require the equipment owner to field-label electrical equipment with labels containing the available incident energy and required level of PPE, to protect both in-house and contract workers from electric shock and arc flash.

Label requirements are determined by site-specific arc flash studies and depend on the inverter model, types and exact locations of external disconnects upstream and downstream of the inverter, by voltages and power levels at any given installation.

NFPA 70E Article 130.3 states that the analysis must be reviewed at least every 5 years or whenever a major modification occurs. This means that the label should include a date, and the date must be documented.

The system is not ready for commissioning until PPE labels have been installed.



Personnel must not wear clothes or accessories that could start fires or generate electrostatic charges or, in general, clothing that can compromise personal safety.

Maintenance operations may only be performed *after* the inverter has been disconnected from the grid and from the PV array.



All operations on the equipment must be performed with adequately insulated clothing and instruments.

E.g.: insulating gloves, class 0, RC category

The maintenance technician must:

- ensure that the inverter is properly locked out/tagged out, so no one else can switch on or operate the device during the maintenance operations
- report any anomaly or damage due to wear or aging so that the correct safety conditions can be restored.

The installer or maintenance technician must always pay attention to the work environment.

Residual risks



Despite the warnings and safety systems, there are still some residual risks that cannot be eliminated.

These risks are listed in the following table with some suggestions to prevent them.

Table of residual risks

RISK ANALYSIS AND DESCRIPTION	SUGGESTED REMEDY
Noise pollution due to installation in unsuitable environments or where individuals routinely work and/or animals dwell most of the time.	Reassess the environment or the place of installation.
Suitable local ventilation that does not cause overheating of the equipment and is sufficient not to create discomfort to people in the room.	Restore suitable ambient conditions and air the room.
External weather conditions, water seepage, low temperatures, high humidity, etc.	Maintain ambient conditions suitable for the system.
Overheating of surfaces at temperature (transformers, coils, etc.) can cause burns.	Use suitable PPE. Wait for the parts to cool down before opening the inverter. Do not restrict cooling openings or heatsinks.
Inadequate cleaning compromises cooling and does not allow the safety labels to be read.	Clean the equipment, labels and work environment
Accumulation of electrostatic energy can generate hazardous discharges.	Ensure components have discharged their energy before working on them.
Inadequate training of staff.	Ask for a supplementary course.
During installation, temporarily mounting the equipment or its components may be risky.	Prevent unauthorized access to the installation area. Use sufficient people and PPE.



Lifting and transport

4

Transport and handling



Protect the inverter from shocks, humidity, corrosive environments (e.g. salt), vibration, etc during transport and handling.

During handling, do not make any sudden or fast movements that can create dangerous swinging.

Lifting

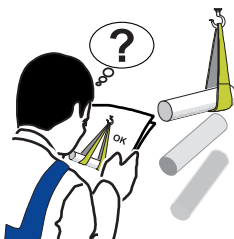

Equipment used for lifting the inverter must be rated for its weight. Do not lift more than one inverter at a time.

Unpacking and incoming inspection

Packaging (cardboard, cellophane, staples, adhesive tape, straps, etc.) may cause cuts and/or injuries if not handled with care. It should be removed with the proper equipment.

Packaging must be disposed of in accordance with any local regulations.

When the packaging is opened, confirm the inverter and components are not damaged and that nothing is missing.

Immediately report any damage or missing parts to the delivery carrier and to ABB Service.

Storage

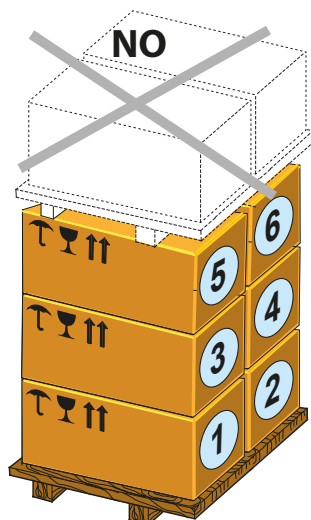

A maximum of 6 inverter may be stacked as shown in the side figure

*DO NOT stack with other equipment or products.
Assembly brackets ① and/or accessory components are inside the packages.*

Weights

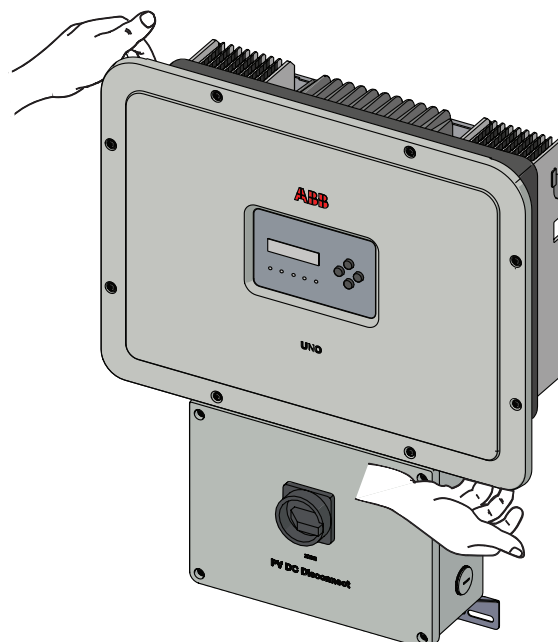

Table: Weights	Weight (Kg/lb)	Lifting points (no.#)
UNO-DM-6.0-PLUS-US	47.4lb (21.5kg)	2

Lifting





The inverter can be lifted by hand by one person without handles or eye bolts. During the operations of lifting make sure to grab the inverter chassis (dark grey surface) located on the rear of the inverter front cover ④. Don't grab the inverter front cover ④ only (light grey part)!

Lifting points:

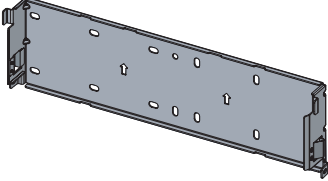

Packing list

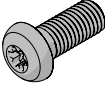
All components required for installation (listed in the below table) are shipped with the inverter.

Components	Quantity	
	Bracket for wall mounting	1
	M5x10 Wall bracket locking screw (to be used if required)	2
	M5 Wall bracket locking washer (to be used if required)	2
	(Spare part) T20 screw for front cover	1
	Cables for the configuration of the input channels in parallel	1+1
	Technical documentation	1

Installation warnings



The inverter must be correctly installed, in a suitable location, to operate properly and safely.



Installers must know and understand applicable NEC requirements and any local codes for photovoltaic systems.



Installers must know and understand OSHA and other applicable safety requirements, including lockout/tagout procedures.



Remember that when the photovoltaic panels are exposed to sunlight they provide continuous DC voltage to the inverter. Before installation may begin, photovoltaic panels must be shaded or isolated.



Before installation may begin, the inverter must be disconnected from the grid (power disconnect switch open and external AC disconnect locked out/tagged out) .



Limit installation to licensed electricians experienced in PV plant wiring.



Obtain approval of the local AHJ before connecting the inverter to the electrical grid



The equipment owner must post the PPE level (per NFPA TDE-2012, Table 13

Installation site and position

- Consult technical data to confirm the environmental specifications will be met
- Installation of the unit in a location exposed to direct sunlight must be avoided (otherwise the warranty will be voided) as it may cause:
 - power limitation phenomena in the inverter (with a resulting decreased energy production by the system)
 - premature wear of the electrical/electromechanical components
 - premature wear of the mechanical components (gaskets) and of the user interface (display)
- Do not install in closed spaces where air does not freely circulate
- Do not install in spaces inhabited by people or animals due to the potential audible noise level of an operating inverter.
- Always ensure that the airflow around the inverter is not restricted or blocked, so as to prevent overheating.
- Do not install the equipment near flammable substances
- Do not install the equipment on wooden walls or supports, or other flammable substances.
- Maintain minimum clearance from objects blocking air circulation and maintain minimum spacing between inverter as indicated in the figures.

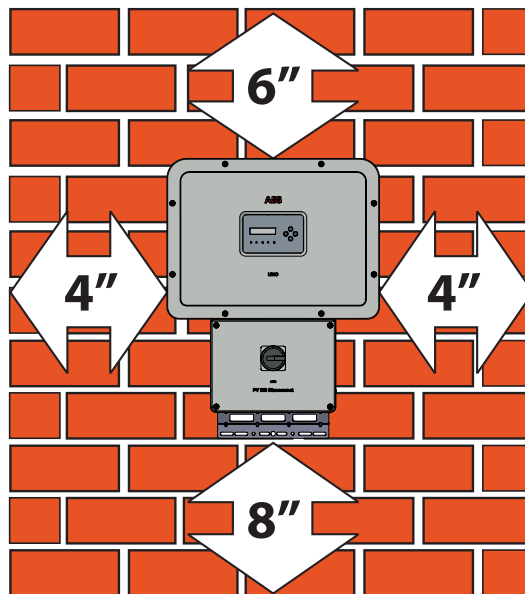

- Maintenance on device hardware and software entails removing the front covers. Check that the correct installation safety distances are observed in order to allow routine check and maintenance operations.
- Install on a wall or strong structure capable of bearing the weight
- Ensure sufficient working area in front of the inverter for wiring box access
- If possible, install at eye level so that the display and LEDs can be easily seen
- Install at a height that takes account of the weight of the equipment
- All installations over 6500' (2,000 meters) must be assessed by ABB Technical Sales to determine the proper datasheet derating
- Install vertically with a maximum inclination of 5° (forward or backward).

If this condition cannot be met, the inverter could undergo derating due to high temperature because of poor heat dissipation.

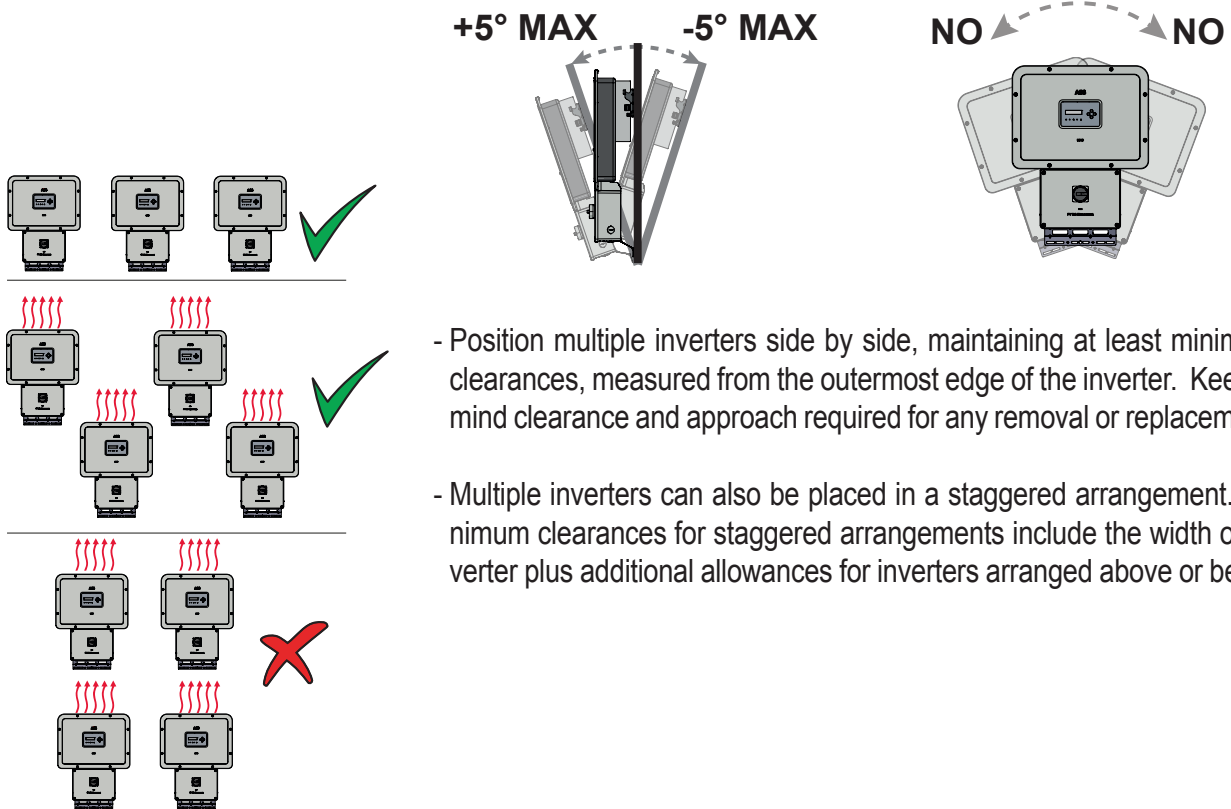

- Position multiple inverters side by side, maintaining at least minimum clearances, measured from the outermost edge of the inverter. Keep in mind clearance and approach required for any removal or replacement!
- Multiple inverters can also be placed in a staggered arrangement. Minimum clearances for staggered arrangements include the width of inverter plus additional allowances for inverters arranged above or below



Do not block access to the external AC and DC disconnects.



Please refer to the warranty terms and conditions to avoid any possible warranty exclusions due to improper installation.

Installation sites with high humidity



Do not open covers to install the inverter if there is precipitation or >95% humidity. Always carefully seal all unused openings.

Even though the device is equipped with an anti-condensation valve, air with extremely high levels of humidity can lead to moderate/low condensation phenomena inside the inverter.

In fact since the inverter is almost completely insulated from the outside once the covers are back in place, after the installation, still some damp air could remain trapped inside the wiring boxes and determine moderate condensation level lately when the temperature drops down at night.

Wireless signal environmental checks

The WLAN board of the inverter uses radio waves to transmit and receive data, it is therefore important to assess this factor in order to have optimal installation.

- Walls in reinforced cement and surfaces covered in metal (doors, shutters, etc.) can markedly reduce the reach of the device which even in optimal conditions, should be of approximately 50 metres in free space.
- It is therefore recommended that before installing the inverter, the strength of the wireless signal is checked, using a mobile device (smartphone, tablet or notebook) and connecting to the wireless router from a position which is close to the installation site of the inverter.

Some installation examples are provided below in different conditions and with the maximum recommended distances between the Inverter and the wireless router.

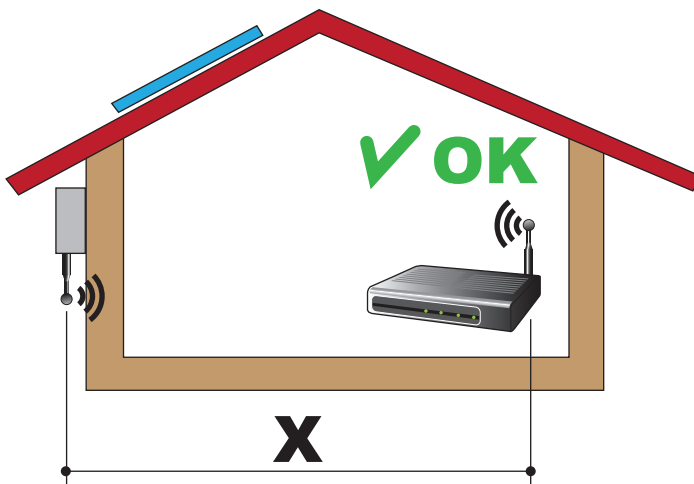

Material of the structure: Wood

Distance X between the Inverter and the wireless Router: less than 10m/33ft

Installation: permitted

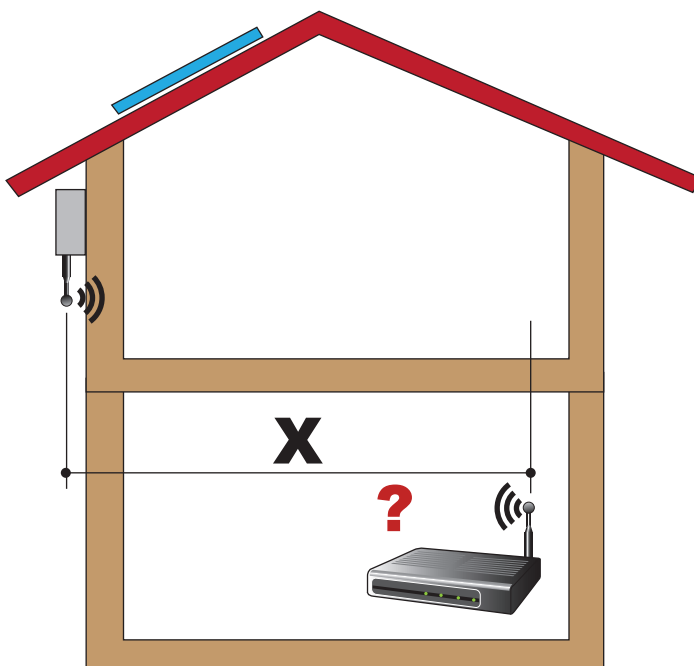

Distance X between the Inverter and the wireless Router: greater than 10m/33ft and/or with obstacles or floors to pass through.

Installation: to be evaluated. Assess the quality of the RF signal and the possibility of extending the signal with a repeater or transferring the Wireless router to the floor above.

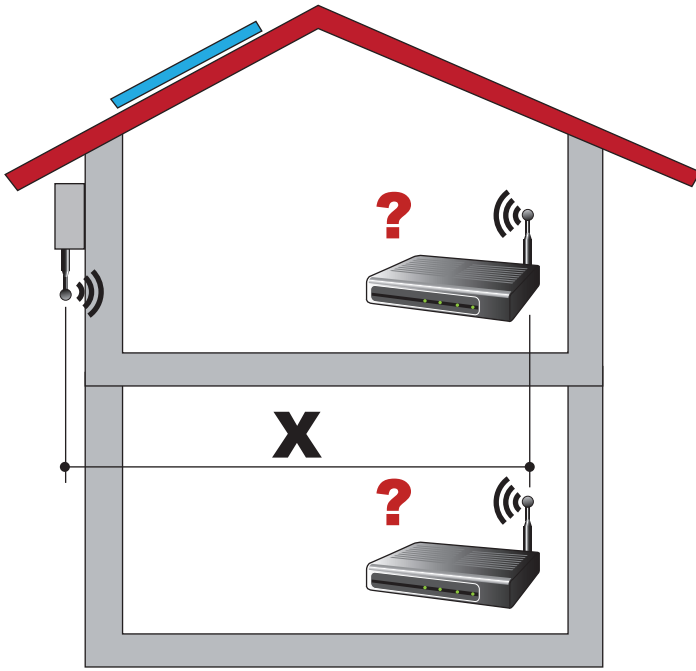

Material of the structure: Concrete

Distance X between the Inverter and the wireless Router: any distance

Installation: to be evaluated. Assess the quality of the RF signal and the possibility of extending the signal with a repeater.

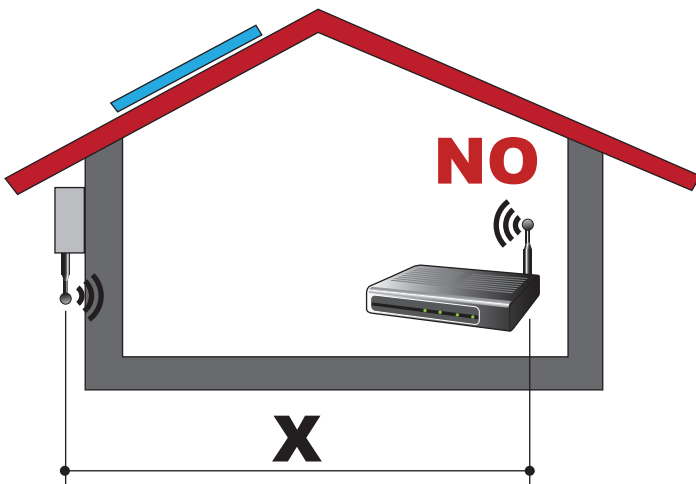

Material of the structure: Metal or reinforced concrete

Distance X between the Inverter and the wireless Router: any distance

Installation: not permitted. Assess the possibility of externally positioning the wireless router antenna (extension) or position the wireless router near a window (in the line of sight of the inverter)



Material of the structure: any material

Distance X between the Inverter and the wireless Router: less than 30m/100ft

Installation: permitted provided that the router is in the line of sight of the inverter (through a window)

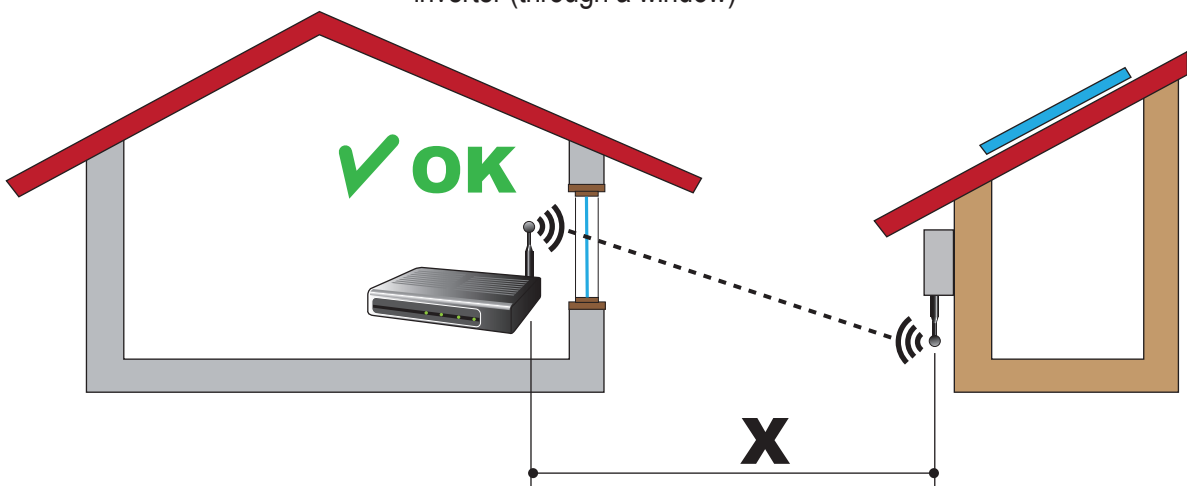

Recommendations for the wireless signal power

The radio signal level between the inverter and the wireless router can be improved in a number of ways:

1. Find a new position for the router considering the different types of materials which the radio signal will have to pass through:

Material	Relative signal reduction
Open field	0% (strength of approximately 50 metres)
Wood / Glass	From 0 to 10%
Stone / Plywood	From 10 to 40%
Reinforced concrete	From 60 to 90%
Metal	Up to 100 %

The quality of the RF signal can be assessed during the installation stage where the signal is displayed in dBm.

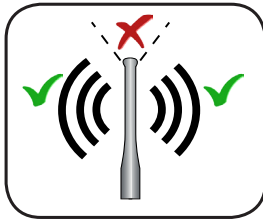

The antenna has a dead zone at its tip, which should not be positioned facing the wireless router, as shown in the figure.

2. Install a wireless signal repeater and place it in an area between the inverter and the router, trying to make sure that the most critical obstacles are avoided.

Wall mounting



During installation do not place the inverter with the front covers ④ ⑤ facing the ground.

Install the inverter by following this procedure:

1. Position the bracket ① on the vertical support (pole, wall, frame, etc) and use it as drilling template. It is the installer's responsibility to choose an appropriate number and distribution of attachment points. The choice must be based on the type of wall, frame or other support, the type of anchors to be used, and their ability to support 4 times the inverter's weight (4 x 47.4lb = 190 lbs for all models).

Attach the bracket to the wall with at least 4 attachment screws. Depending on the type of anchor chosen, drill the required 4 holes (minimum) ④ to mount the bracket.

2. Attach the bracket to the wall or frame



Risk of injury due to the weight of the equipment.

3. Lift the inverter and hang it to the bracket ① by inserting the two supports in the slots on the inverter (Figure ②).

4. Proceed to anchor the inverter to the bracket by pressing the lower part toward the wall or frame until the two springs ② on the bracket ① set the inverter in position (Figure ②).

5. Secure the lower bracket of the inverter to the wall or frame using an appropriate type of anchor.

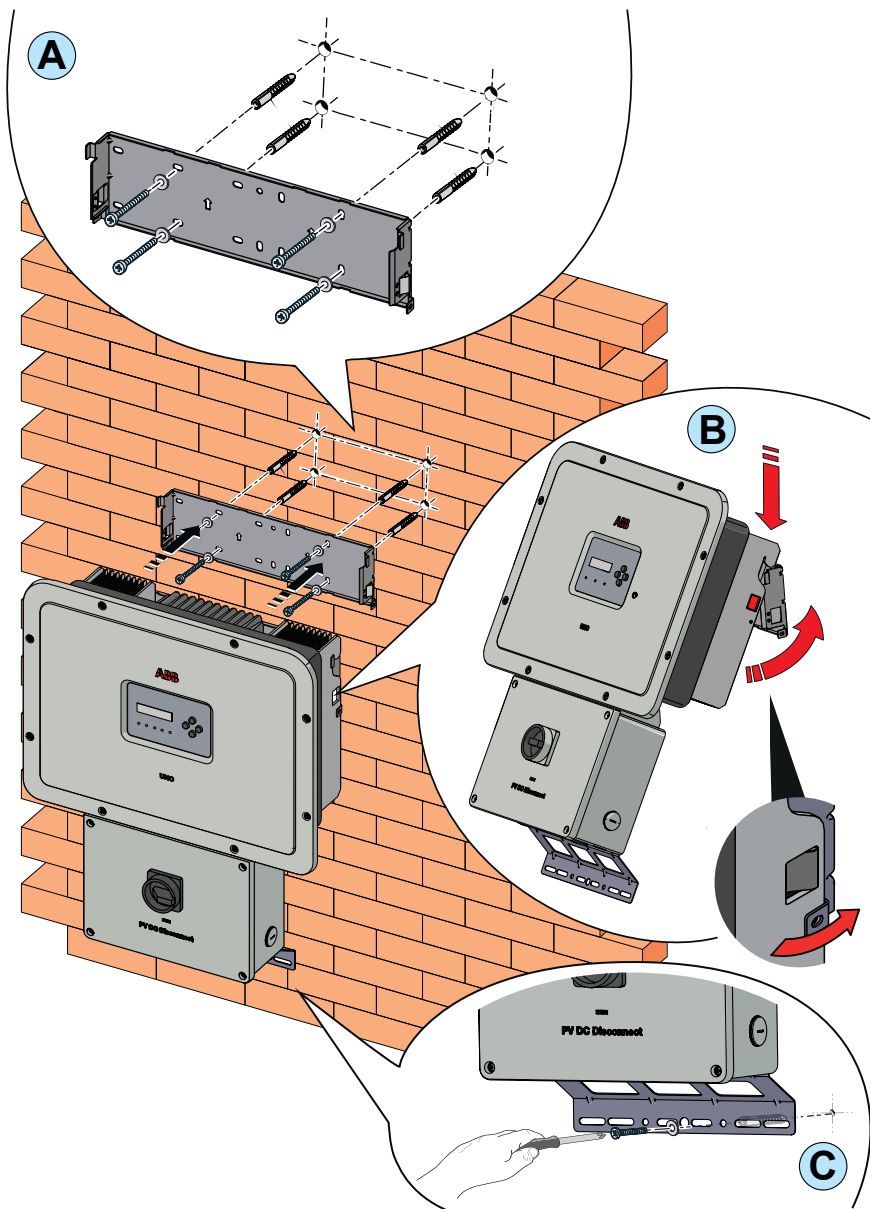

Opening the front cover



WARNING! ELECTRIC SHOCK HAZARD! Hazardous voltages may be present inside the inverter. The access to the internal zones of the inverter must be carried out after a minimum waiting time of 5 minutes since the inverter was disconnected from the grid and from the photovoltaic generator.



The main connections are made on the wiring box of the inverter by removing the 4 screws, using a TORX T20 key, of the front cover ⑤. If required to install the accessory boards and make the necessary connections, unscrew the 8 screws, using a TORX T20 key, and open the front cover ④ of the inverter compartment; while removing the screws, pay special attention since additional screws are not supplied.



Do not open the inverter in the case of rain, snow or a high level of humidity (>95%)



Caution! It's necessary to hold the front cover during the screws removal to avoid his falling (the front covers aren't secured to the inverter's chassis).

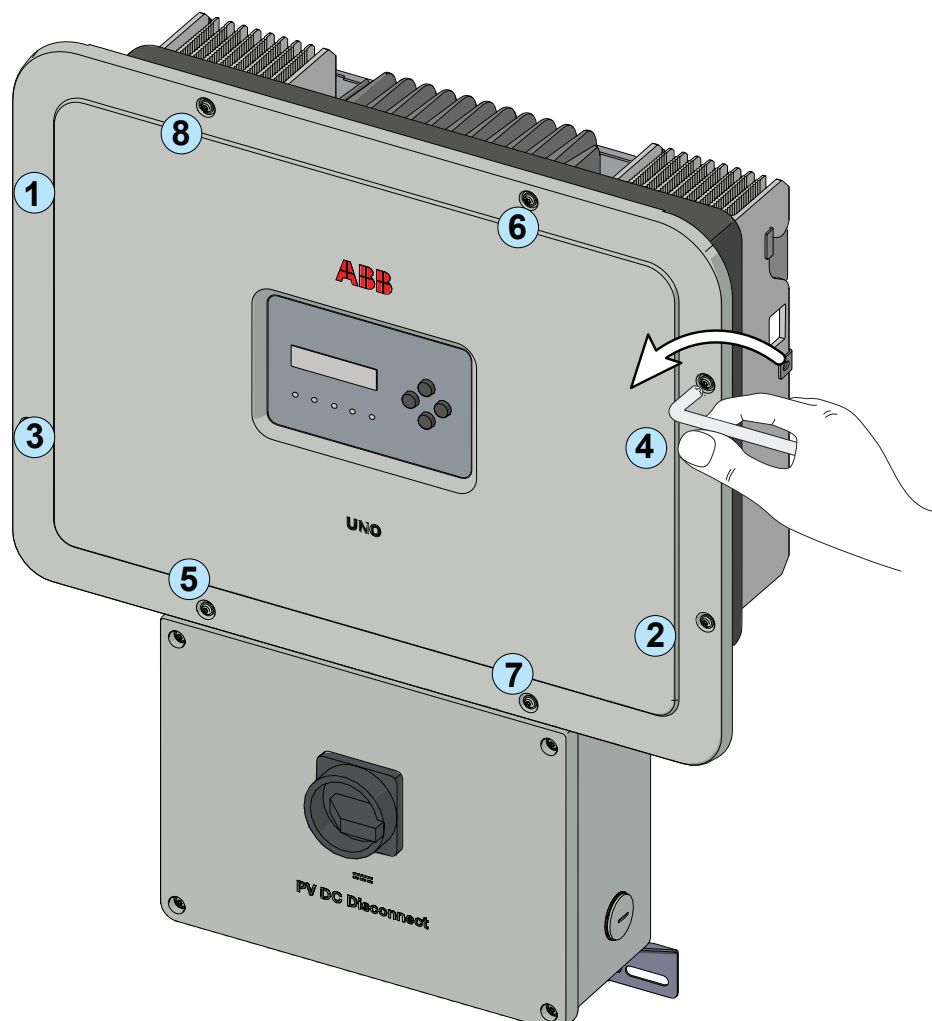

Installation planning

Always respect the nominal ratings of voltage, current, and power defined in the technical data table, when designing your system.



Observe the following considerations in design:

To reduce the risk of fire, connect only to a circuit provided with a branch circuit overcurrent protection in accordance with NEC (ANSI/NFPA 70). See Maximum AC OCPD requirement in following paragraph.



This UNO inverter is designed without an isolation transformer and is intended to be installed per NFPA 70, 690.35 with an ungrounded PV array.



An automatic overcurrent device (e.g. circuit breaker) must be installed between the UNO inverter and the AC utility grid. It is the responsibility of the end user to provide protection for the AC output circuit.

AC overcurrent protection

AC output overcurrent protection is not provided in the inverter; it is the responsibility of the end user to provide overcurrent protection for the AC output circuit. To reduce the risk of fire, connect only to a dedicated circuit provided with overcurrent protection in accordance with the NEC (ANSI/NFPA 70):



UNO-DM-6.0-TL-PLUS-US

Type	Typical installations use a 2-pole/600V rated, bi-directional thermal-magnetic circuit breaker, UL489 or equivalent.
Maximum Current/Voltage	UNO-DM-6.0-TLPLUS → 40A/600V for 208V and 240V grid

Choice of grid output connection type (AC side)

Determine which AC output is applicable for the inverter model being installed. The AC wiring connections based on the AC grid type are shown in the table below.

GRID STANDARD TYPE DE RÉSEAU						
	208V~ 3PH - Δ			240V~ SPLIT-PHASE		
TERMINAL BORNE	1	2	3	1	2	3
WIRE CÂBLE	L1	L2	-	L1	L2	N



Caution! Connect the ground before the grid connections.

Sizing the ground cable(s)

ABB inverters must be grounded at the protective earth (PE) connection point ⑲ ⊕ terminal.

Size the cable(s) in accordance with NEC and any local codes.



The wire must be large enough to handle the maximum ground fault current that the PV system might experience.



The warranty is void if the inverter isn't connected to ground through the appropriate terminals.

Follow site wiring diagrams and grounding plans. At a minimum expect this to include:

- A PV array equipment ground connection
- Inverter protective earth (PE) connection

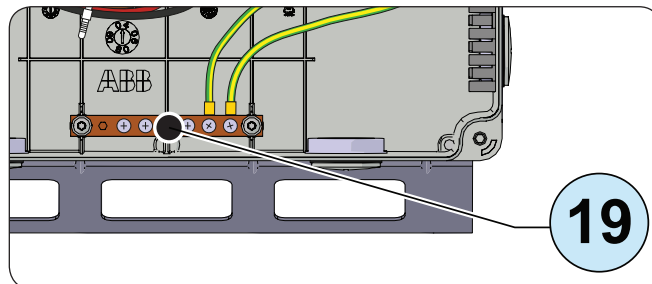

The Protective Earth (PE) connection point ⑲, located inside the wiring box, accept 4 wires 8AWG to 4AWG, copper (Torque to 2.0Nm / 1.5 ft-lb).

Sizing the AC cable

The AC output conductors must be sized according to operating temperature range and continuous current ratings.

- Size conductors per NEC Article 310.
- Use 90°C wire only;
- AC wiring terminals ⑰ are spring pressure type and accommodate a wire size range of 20-6 AWG

Note that undersized wiring may cause nuisance tripping (disconnection) of the inverter. Too-high wiring impedance increases the AC voltage seen at the inverter terminals. In compliance with UL1741 and IEEE1547, the inverter may need to disconnect from the grid under otherwise normal grid operating conditions: IEEE1547 default settings mandate the inverter operate only if its terminal voltage is in the $[+10\%/-12\%] \cdot V_{nom}$ range. To limit these issues, the system designer must consider the worst case grid voltage conditions and wiring run lengths between the inverter to the point of common connection, and size wiring appropriately. For North America, based on ANSI B values, the worst case voltage range is $\pm 6\%$ of V_{nom} and line voltage drop in this case should be limited to *less than* 3% of V_{nom} . Lower is better, so not to dissipate harvested power as heat.

Clamps terminal use

All power conductors will be inserted in spring clamp terminals.

The figure shows an example of how to make the wires connection:

- Insert a small flat screwdriver in the slot and lightly press the screwdriver from top to bottom; insert the screwdriver until the spring opens.
- Insert the cable in the spring clamp.
- Remove the screwdriver.
- When connections are complete, give each wire a pull test

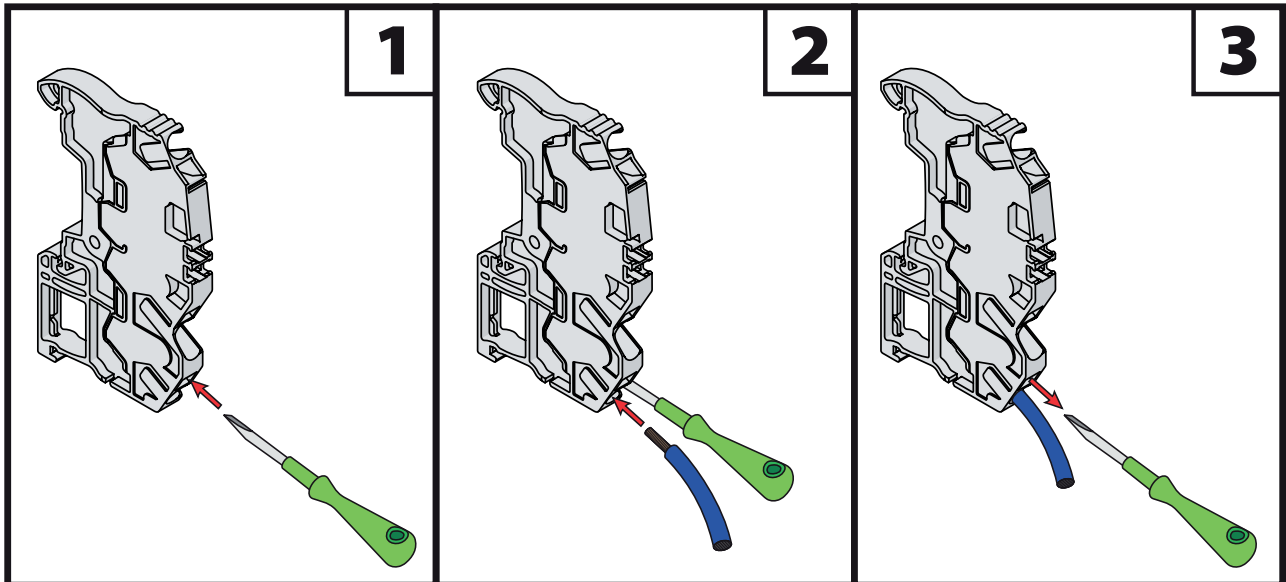

Preliminary operations for connection of the PV generator

Independent or parallel input channels configuration

The inverter is equipped with two input channels (thus benefiting from two trackers for MPPT maximum power point tracking) which work independently of one another, which can be paralleled by leveraging a single MPPT.

Strings of photovoltaic modules having the same type and number of panels in series must be connected to each single channel; they must also have the same installation conditions (in terms of orientation to the SOUTH and inclination from the horizontal plane).

When connecting the two input channels in parallel, you must comply with the above requirements in order to benefit from the ability to leverage the full power of the inverter output on a single channel.

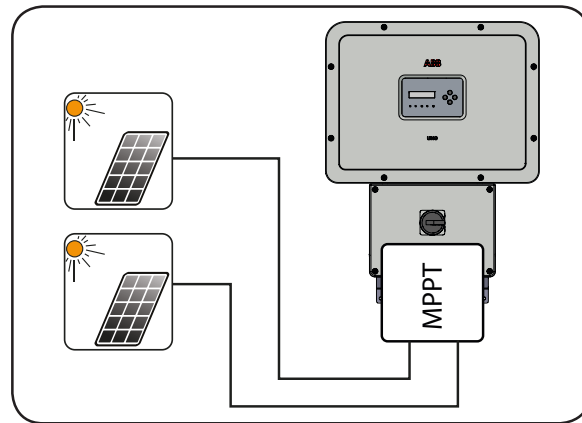

The dual MPPT structure however allows management of two photovoltaic generators which are independent of each other (one for each input channel), and which may differ between themselves with regard to installation conditions, type and number of photovoltaic modules connected in series. A necessary condition for the two MPPT to be used independently is that the photovoltaic generator connected to each of the inputs has a lower power than the power limit of the single input channel and a maximum current lower than the current limit of the single input channel.

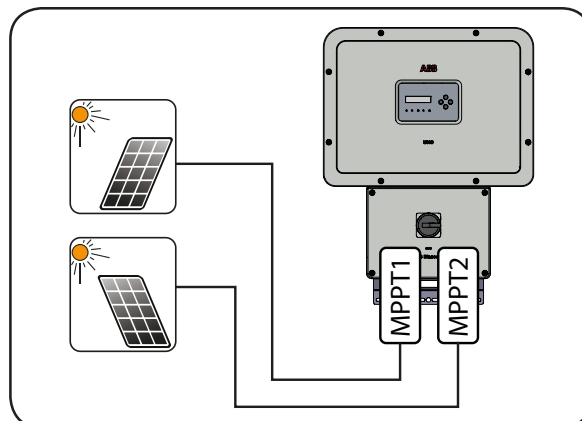

All input parameters that must be met for correct inverter operation are shown in the "technical data" table.

Channel configuration examples

PV generator characteristics	MPPT configuration	Notes
<p>The photovoltaic generator consists of strings having a different number of modules in series from each other.</p> <p>The photovoltaic generator consists of strings that have different installation conditions from each other.</p>	<p>MPPT configuration has to be INDEPENDENT</p>	<p>A NECESSARY condition so that the two MPPTs can be used in independent mode is for the photovoltaic generator connected to each of the inputs to have a power lower than the power limit of the single input channel AND a maximum current lower than the current limit of the single input channel.</p>
<p>The photovoltaic generator consists of strings having the same number of modules in series as each other.</p> <p>The photovoltaic generator consists of strings that have the same installation conditions, that is to say, all the strings have the same inclination from the horizontal and the same orientation to the SOUTH.</p> <p>The photovoltaic generator connected to each of the inputs has a power lower than the power limit of the input channel AND a current lower than the current limit of the input channel.</p>	<p>Possibility of choosing between the configuration with MPPT as INDEPENDENT or PARALLEL</p>	<p>A NECESSARY condition so that the two MPPTs can be used in independent mode is for the photovoltaic generator connected to each of the inputs to have a power lower than the power limit of the input channel AND a maximum current lower than the current limit of the input channel.</p> <p>An ADVISABLE (*) condition so that the two MPPTs can be connected in parallel is for the photovoltaic generator connected to the two inputs to consist of strings made by the same number of modules in series and for all the modules to have the same installation conditions.</p>
<p>(*) <i>This condition is advisable from the point of view of the energy production of the system, not from the point of view of inverter operation.</i></p>		
<p>The photovoltaic generator consists of strings having the same number of modules in series as each other.</p> <p>The photovoltaic generator consists of strings that have the same installation conditions, that is to say, all the strings have the same inclination from the horizontal and the same orientation to the SOUTH.</p> <p>The photovoltaic generator connected to each of the inputs has a power higher than the power limit of the input channel OR a current higher than the current limit of the input channel.</p>	<p>MPPT configuration has to be PARALLEL</p>	<p>A SUFFICIENT (*) condition so that the two MPPTs must be used in parallel mode is for the photovoltaic generator connected to each of the inputs to have a power higher than the power limit of the single input channel OR a maximum current higher than the current limit of the single input channel.</p> <p>An ADVISABLE (**) condition so that the two MPPTs can be connected in parallel is for the photovoltaic generator connected to the two inputs to consist of strings made by the same number of modules in series and for all the modules to have the same installation conditions.</p>
<p>(*) <i>This condition is sufficient from the point of view of the energy production of the system, not from the point of view of inverter operation.</i></p> <p>(**) <i>This condition is advisable from the point of view of the energy production of the system, not from the point of view of inverter operation.</i></p>		



Independent channel configuration (default configuration)

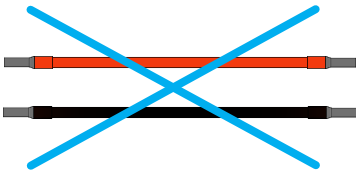

This configuration is set at the factory and involves the use of the two input channels (MPPT) in an independent mode. This means that the jumpers (supplied) between the positive and negative poles of the two DC input channels ⑫ must not be installed, and that the “independent” channel mode should be set during the commissioning phase via internal webserver (step 4) or through the inverter display menu “**Inverter > Settings > Input Mode**”.

Parallel channel configuration



This configuration involves the use of the two input channels (MPPT) connected in parallel. This means that the jumpers (supplied) between the positive and negative poles of the two DC input channels ⑫ must be installed, and that the “parallel” channel mode should be set during the commissioning phase via internal webserver (step 4) or through the inverter display menu “**Inverter > Settings > Input Mode**”.

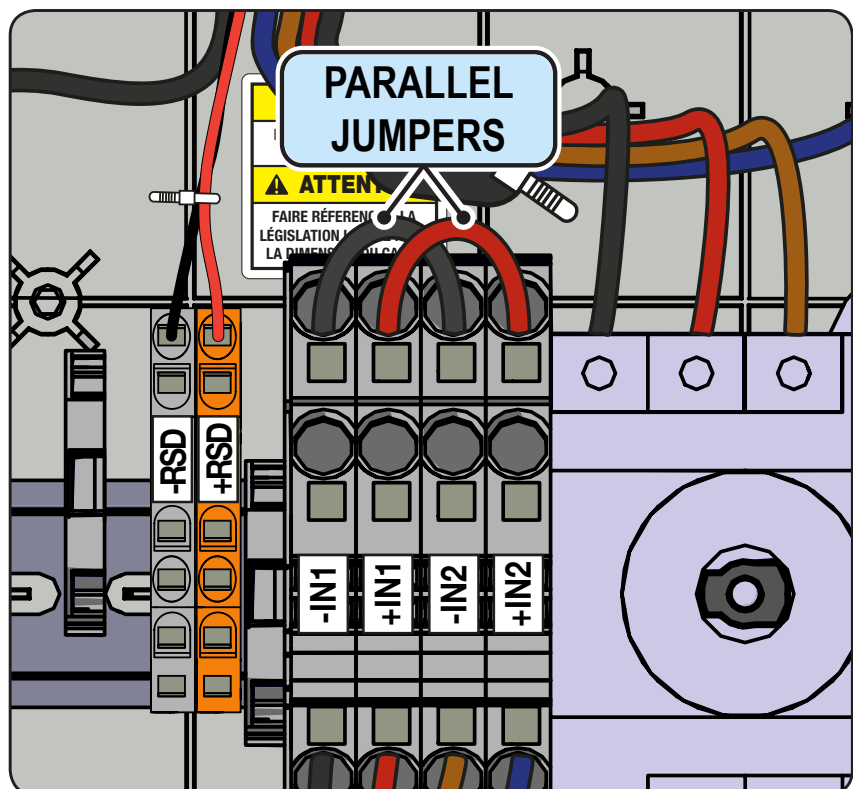

Checking the correct polarity of the strings

Using a voltmeter, check that the voltage of each string has the correct polarity and falls within the input voltage limits of the inverter (see technical data).



Polarity inversion can cause serious damage.

If the open circuit voltage of the string is near the maximum value accepted by the inverter, consider that low ambient temperatures cause an increase in the string voltage (different according to the photovoltaic module used). In this case it is necessary to carry out a check of the sizing of the system and/or a check on the connections of the modules of the system (e.g.: number of modules in series higher than the design number).

Checking of leakage to ground of the photovoltaic generator

Measure the voltage present between the positive and negative pole of each string with respect to ground.

If a voltage is measured between an input pole and ground, it may be that there is a low insulation resistance of the photovoltaic generator and the installer will have to carry out a check to solve the problem.



Do not connect the strings if a leakage to ground has been detected, as the inverter might not connect to the grid.

Electrical connection to the PV field - DC side

After having carried out preliminary checks and therefore having verified that there are no problems in the photovoltaic system, and the channel configuration has been selected (parallel or independent) you may connect the inputs to the inverter.

Confirm the correct polarity in the input strings.

Confirm there is no ground leakage current in the PV array.

When exposed to sunlight, the PV panels supply DC direct voltage to the inverter.

The inverter's DC switch disconnects the DC current from the PV panels. In the "OFF" position the inverter will stop producing power, but DOES NOT disconnect the AC from the grid. To prevent electrocution hazards, all the connection operations must be carried out with the external AC disconnect switch, downstream of the inverter (grid side), open and locked out.



The transformerless design requires that the PV array to be floating with respect to ground per NEC 690.35.

DC PV string wire must be UL-listed wire per NEC 690.35 with rated minimum 600V.

PV output conductors (wiring) must consist of sheathed (jacketed) multi-conductor cables or single insulated conductors (wires) which must be installed in an approved raceway. These conductors must be isolated from the enclosure and system grounding, as required by NEC 690.35. This is the responsibility of the installer.



Confirm that the maximum PV array short circuit current for each DC input channel is within the inverter specification. Array equipment grounding must be installed per the requirements of the NEC and is the responsibility of the installer. A configuration program that can help to correctly size the photovoltaic system is available on at <http://www.stringsizer.abb.com>.



- Turn the DC switch OFF
- Loosen the four captive screws on the wiring box cover (Torx 20) and remove the cover
- Remove the threaded plastic plug and nut from the DC cable opening ⑬.
- Insert the appropriate water-tight conduit connector and tighten to the chassis to maintain NEMA 4X compliance.

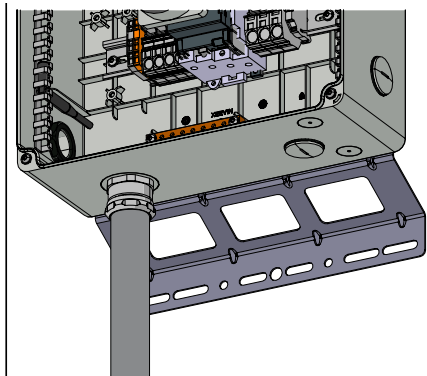
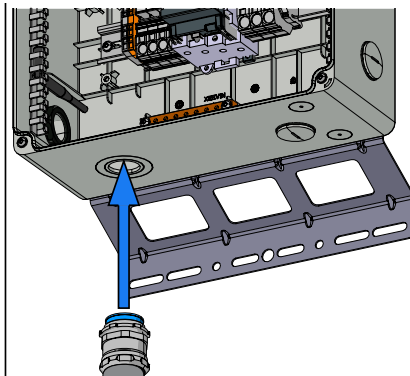
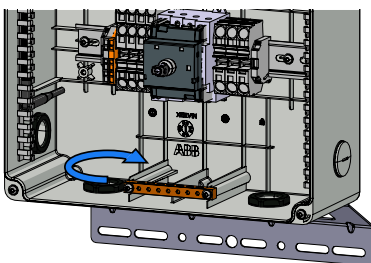

- Run the DC wires through the openings dedicated to the DC conduit.



Conduit must be sealed using water-tight fittings to maintain NEMA Type 4X enclosure integrity.

- Connect the DC wiring to DC input terminal blocks ⑫. DC wiring terminals are spring pressure type and accommodate a wire size range of 20-8AWG. Connect the strings in either independent or parallel mode, following the appropriate set of instructions below:

DC connection with INDEPENDENT MPPT configuration

If two PV arrays with each be below the maximum input current rating of the inverter, they may be connected as “IND” array, each with its own MPPT. In this case, do nothing with the jumper wires which came with the inverters.

- Connect the positive side of the first PV array to +IN1, and its negative side to -IN1.
- Connect the positive side of the second PV array to +IN2 and its negative side to -IN2. Up to four strings can be connected in independent mode.
- During commissioning, confirm that the input mode is set to IND.

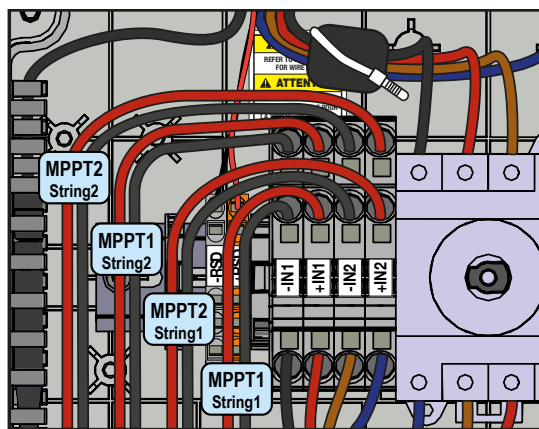

DC connection with INDEPENDENT MPPT configuration

If a PV array’s output current is more than the rating for a single inverter channel:

- Connect the red jumper wire between the +IN1 and +IN2 terminal block inputs. Then connect the jumper wire black wire between the -IN1 and -IN2 terminals. Remember later to set the input mode to PAR from the display (Settings>Input Mode>Parallel).
- Connect the array to the IN1 (MPPT1) and IN2 (MPPT2) input positions, running separate wires for positive (+) and negative (-) for each array.

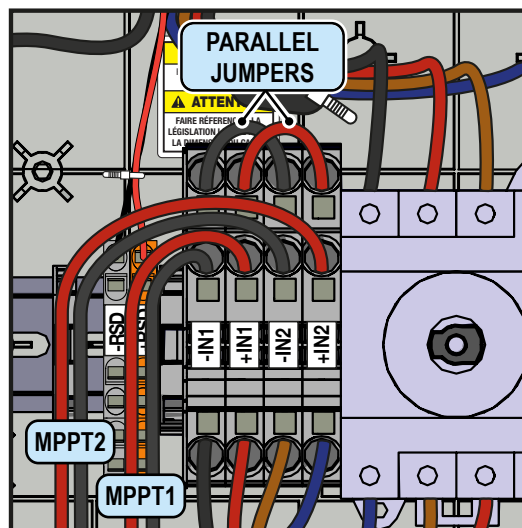

Grid output connection (AC side)





Wire must be sized based on ampacity requirements of the NEC or other applicable prevailing code.

To prevent electrocution hazards, all the connection operations must be carried out with the external AC disconnect switch downstream of the inverter (grid side) open and locked out.

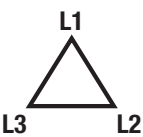

Any failure of the inverter when it is not connected to ground through the appropriate terminal is not covered by the warranty.

AC grid wiring is based on the grid standard shown in the utility configuration table below.

GRID STANDARD TYPE DE RESEAU						
	208V~ 3PH - Δ			240V~ SPLIT-PHASE		
TERMINAL BORNE	1	2	3	1	2	3
WIRE CÂBLE	L1	L2	-	L1	L2	N

Connection to AC terminal block

- Run an approved raceway between inverter and external AC OCPD.
- Remove the threaded plastic plug and nut from the AC cable opening ⑭.
- Insert the appropriate water-tight conduit connector and tighten to the chassis to maintain NEMA 4X compliance.

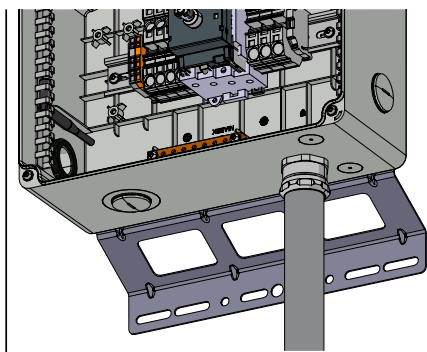
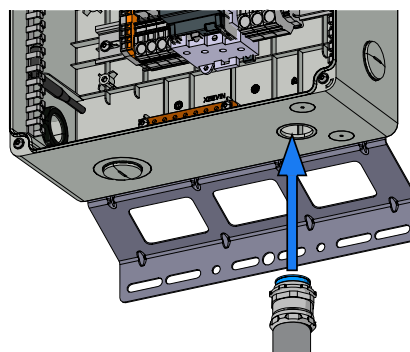
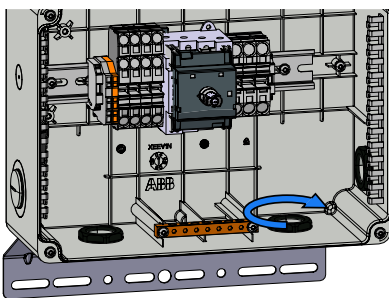

- Make appropriate conduit runs from grid and pull the AC conductors through the raceway to the inverter.



Conduit must be sealed using water-tight fittings to maintain NEMA Type 4X enclosure integrity.

- Connect the conductors to the correct terminals on the AC output terminal block ⑩ (wire size range of 20-6 AWG) based on the AC grid standard used in the table above.

- Connect the main AC ground cable in the raceway to protective earth (PE) connection point ⑰.



If several inverters are installed to a three-phase AC GRID, always distribute the inverters between the phases in order to reduce power imbalance between the phases. Always refer to the local standards.

Grid standard setting of the country

In addition to the selection of grid voltages based on the installation site, grid parameters may be dictated by the utility company or authority having jurisdiction according to the country in which the inverter is installed.

The selection of the country standard must be done during commissioning wizard phase. See dedicated paragraph on Chapter 7.



Rapid Shutdown (RSD) connection

The installer must use an external rapid shutdown device compliant with the 2014 NEC.

Automatic shutdown occurs at the rooftop box when utility power is lost or when the PV system's AC disconnect switch is opened. In jurisdictions requiring a dedicated activation switch, install an emergency stop button external to the inverter.

The wiring box has 24Vdc (0.4A max) on a spring-loaded terminal block to the left of the PV input area, which is designed to be used to power a RSD device.

RSD wiring terminals accommodate a wire size range of 26-12 AWG.

- Install RSD device wires in the RSD terminal block;
- +24V wire to +RSD terminal,
- 24V wire to - RSD terminal

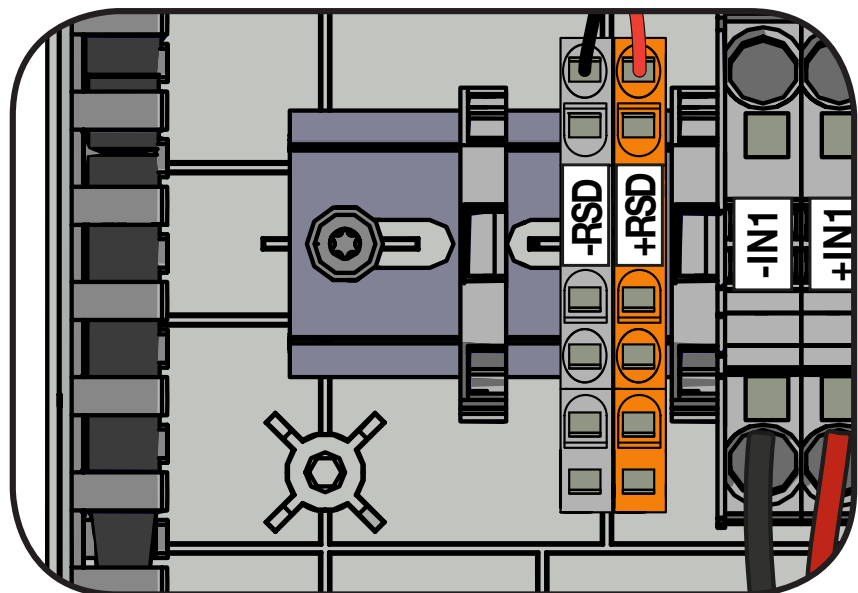

NOTE: If a RSD device was installed into the plant, it also will need to connect the AC grid to allow the inverter to power-up!

Communication and control signal connections to the accessory UNO-DM-COM KIT board

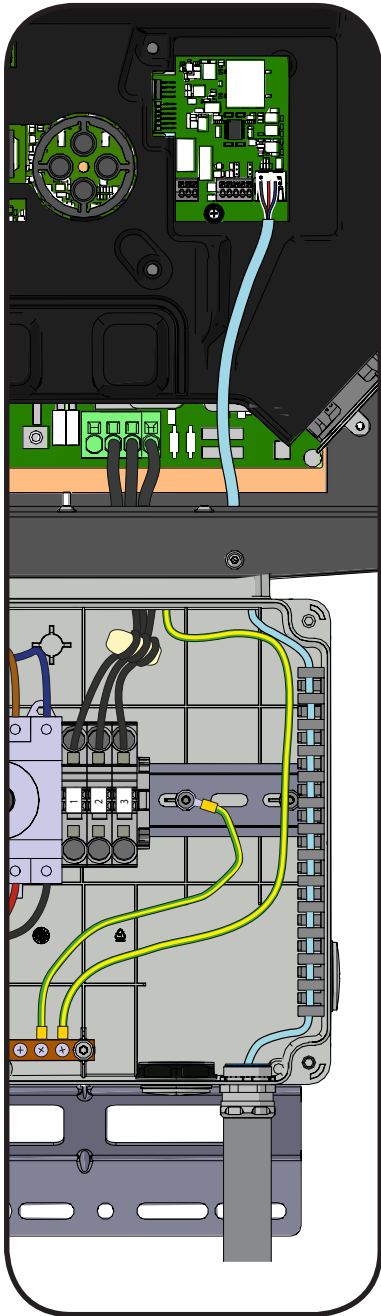

To connect the signal cables to the UNO-DM-COM KIT or UNO-DM-PLUS-Ethernet COM KIT board is necessary to:

- Remove both front covers (wiring box ①⑤ and inverter compartment ①④)
- Insert the appropriate water-tight conduit connector on signal conduit opening ①⑤ and tighten to the chassis to maintain NEMA 4X compliance. *Conduit must be sealed using water-tight fittings to maintain NEMA Type 4X enclosure integrity.*
- Run the cables through the signal cable conduit
- Run the cables through the plastic cable tray on the internal right side of the wiring box
- Run the cables through the specific cable conduit present on the plastic shield of the mainboard.

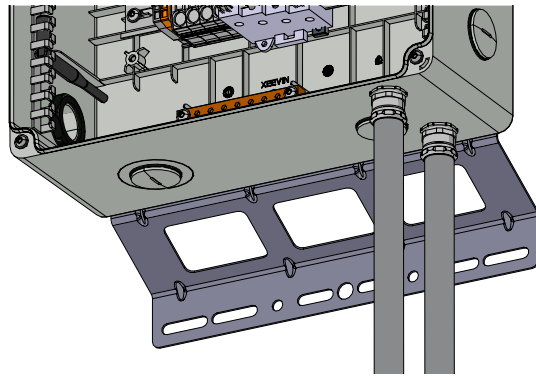
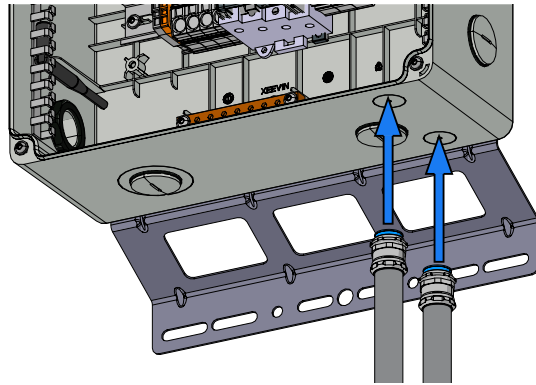

The connection of the wires to the terminals is performed as follows:

1. Press and hold the button corresponding to the terminal where the wire is to be connected
2. Insert the cable
3. Release the button
4. Pull the wire to check the tightness.

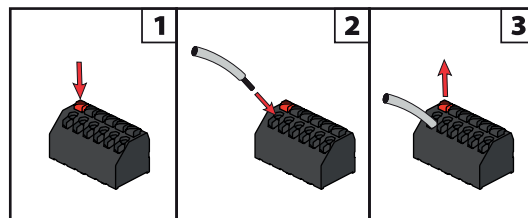

Description of terminal blocks on the UNO-DM-COM KIT board

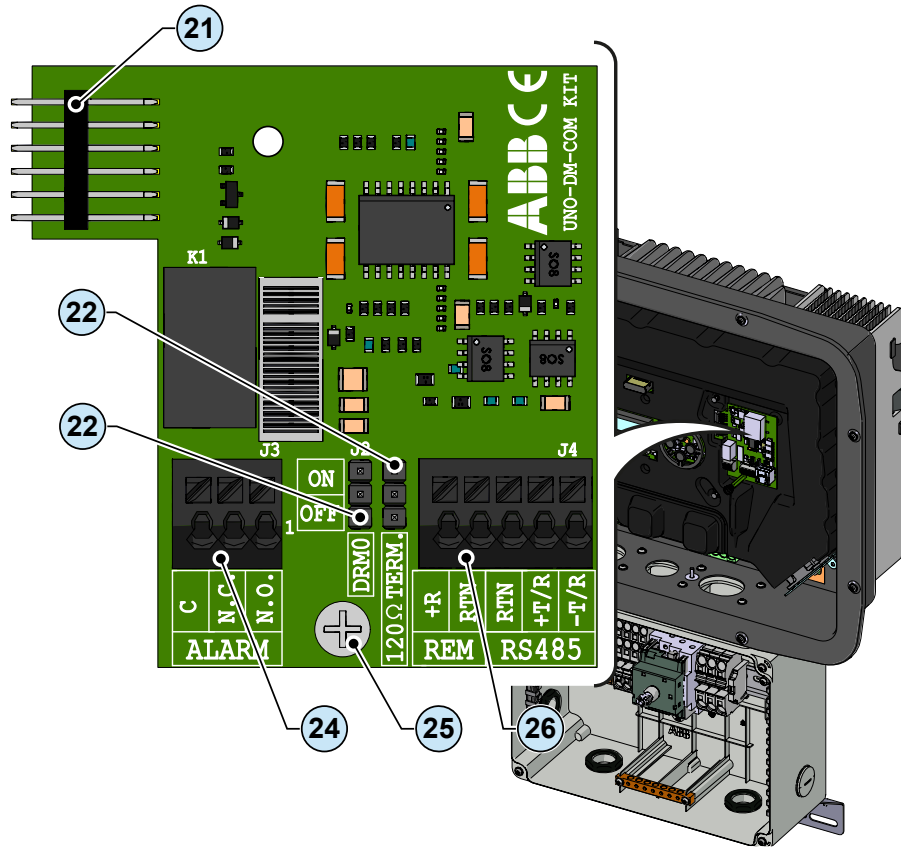

Description of multifunctional relay terminal block ②④:

Terminal name	Terminal number	Description
ALARM	N.C.	"Normally closed" terminal of multifunctional relay
	C	"Common" terminal of multifunctional relay
	N.O.	"Normally open" terminal of multifunctional relay

Description of communication and control signal terminal block ②⑥:

Terminal name	Terminal number	Description
REM	+R	Remote external ON/OFF command
	RTN	Reference (RTN) of the Remote external ON/OFF command
RS485	RTN	Reference (RTN) of the RS485 communication line
	+T/R	+T/R of the RS485 communication line
	-T/R	-T/R of the RS485 communication line

Description of terminal blocks on the UNO-DM-PLUS-Ethernet COM KIT board

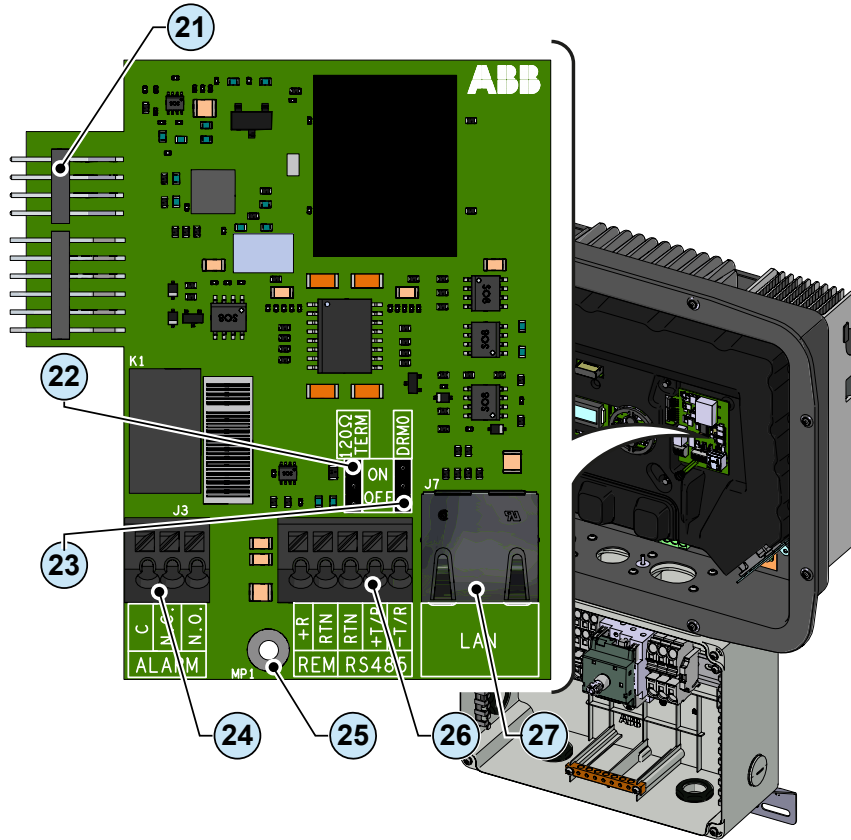

Description of multifunctional relay terminal block ②④:

Terminal name	Terminal number	Description
ALARM	N.C.	"Normally closed" terminal of multifunctional relay
	C	"Common" terminal of multifunctional relay
	N.O.	"Normally open" terminal of multifunctional relay

Description of communication and control signal terminal block ②⑥:

Terminal name	Terminal number	Description
REM	+R	Remote external ON/OFF command
	RTN	Reference (RTN) of the Remote external ON/OFF command
RS485	RTN	Reference (RTN) of the RS485 communication line
	+T/R	+T/R of the RS485 communication line
	-T/R	-T/R of the RS485 communication line

Connection of the RS485 line

On the inverter models which equip the UNO-DM-COM KIT or UNO-DM-PLUS-Ethernet COM KIT board it is possible to use the RS485 communication port for: Integrating the inverter with a third party monitoring and control systems; Carrying out “daisy-chain” (“in-out”) connections of multiple inverters installation; Setting internal inverter parameters with the dedicated advanced configuration software “Aurora Manager Lite”.



The inverter RS485 communication protocol must be properly configured depending on the device to which it communicates. The RS485 protocol can be changed through the relevant section of internal webserver (see the specific chapter) or through the display and the keyboard (see the specific chapter).

The connection of the serial communication cable must be made to the specific RS485 connector ②⑥ present on the UNO-DM-COM KIT board.

For connection of the RS485 communication line is necessary a three-wire shielded cable. The cable specifications are described in the following table:

Cable type	AWG	Characteristic impedance	Operating voltage	Operating temperature
Shielded	22 - 24	120 Ohm	≥300 V	-20...+60 °C

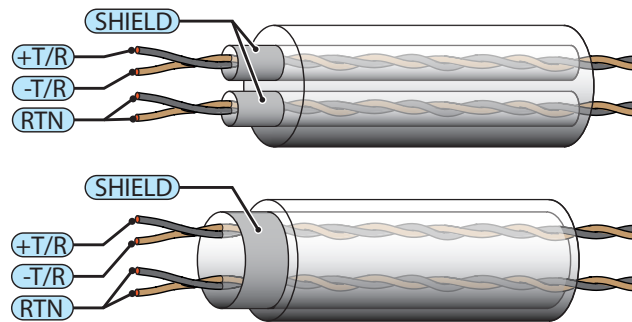

Shield continuity must be provided along the communication line and must be grounded at a single point. It is recommended not to exceed a length of 1000m for the communication line.

The cabling of the RS485 line must be wound up to the toroidal provided in the package (1 winding); this toroidal shall be conveniently placed near the cable gland which is in the bottom part of the inverter.

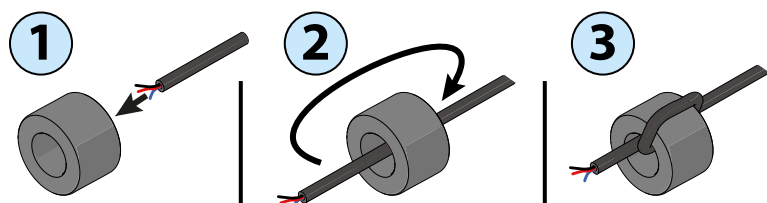

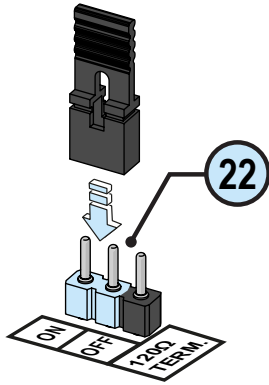

The RS485 HALF-DUPLEX communication line is made up of two transmission and reception cables (+T/R and -T/R) and a communication reference cable (RTN): all three cables must be connected in daisy-chain configuration (it's recommended to make connection external to the inverter).

The RS485 connection can be made by using the terminal block 26.

The last inverter of a daisy chain shall be terminated: within the last inverter itself the provided jumper at the pins marked "120Ohm TERM." shall be placed in ON position in order to enable the termination the RS485 communication line 22 with a resistance present onboard.

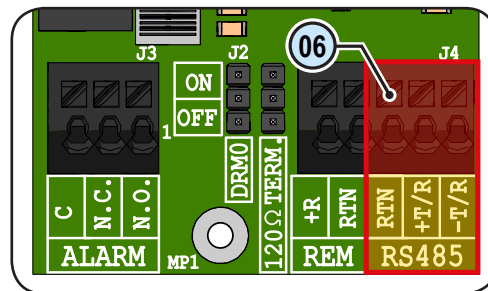

After the connection is completed RS485 inverter address have to be chosen between 1 and 63.

The setting of the address on the inverter is done through the relevant section of internal webserver (see the specific chapter) or through the display and the keyboard (see the specific chapter).

Each inverter is supplied with the preset RS485 address "2" and with the jumper termination resistance 22 in the OFF position.

Remote control connection

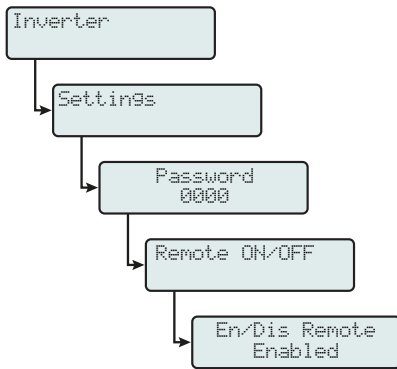

The connection and disconnection of the inverter to and from the grid can be controlled through an external control.

The function must be enabled in the specific section of internal webserver (see the specific chapter) or through the display and the keyboard in the specific menu (see the side picture). If the remote control function is disabled, the switching on of the inverter is dictated by the presence of the normal parameters that allow the inverter to connect to the grid. If the remote control function is operating, besides being dictated by the presence of the normal parameters that allow the inverter to connect to the grid, start-up of the inverter also depends on the state of the terminal **R+** compared to the terminal **RTN** present on the connector ②⑥.

When the **R+** signal is brought to the same potential as the **RTN** signal (that is to say when a short-circuit is created between the two connector terminals), the inverter is disconnected from the grid.

The remote control OFF condition is shown on the display.

Connections for this command are made between input “**R+**” and “**RTN**”.

Since this is a digital input, there are no requirements to be observed as regards cable cross-section (it only needs to comply with the sizing requirement for passing cables through the cable glands ②⑩ and the terminal connector ②⑥). The cable specifications are described in the following table:

AWG	Operating voltage	Operating temperature
22 - 24	≥300 V	-20...+60 °C

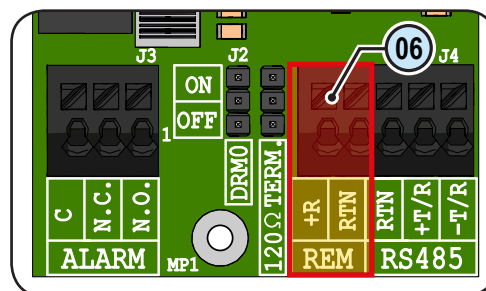

Demand Response Mode 0 (Request by AS/NZS 4777)

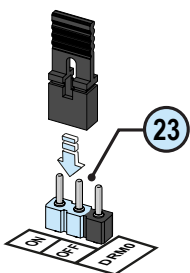

Where requested by the AS/NZS 4777 standard, it's possible to use the REM terminal block ②⑥ for the Demand Response Mode 0 (DRM0) functionality. The function could be activated by placing the provided jumper ②③ in “ON” position.



In case of the DRM0 function is activated without the proper wiring of the REM terminal block ②⑥, the inverter will no longer be able to connect to the grid. For further information regarding the DRM0 function refer to the AS/NZS 4777 standard.

Configurable Relay connection (ALARM / LOAD MANAGER)

The UNO-DM-COM KIT or UNO-DM-PLUS-Ethernet COM KIT boards is equipped with a relay with configurable activation that allows connection of external devices which for example, signal malfunctions to manage loads with a specific configurable power input threshold, according to the mode selected in the specific section of internal webserver (see the specific chapter) or in the display menu "INVERTER > SETTINGS > ALARMS > SET ALARM TYPE". The connection must be made to the specific ALARM terminal block ②4.

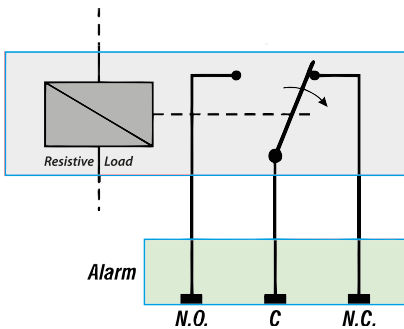
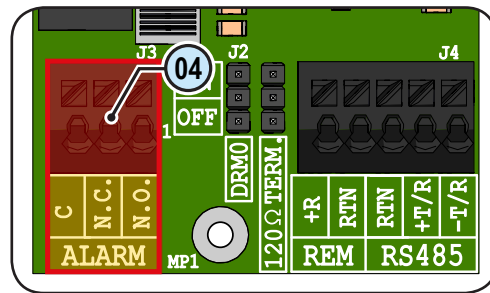

The configurable relay can be used with normally open contact (being connected between the NO terminal and the common contact C) and with normally closed contact (being connected between the NC terminal and the common contact C).

Different types of devices (light, sound, etc.) can be connected to the relay, provided they comply with the following requirements:

Relay Rating:

Maximum Voltage: 240 Vac

Maximum Current: 1 A

The cable specifications are described in the following table:

AWG	Operating voltage	Operating temperature
22 - 24	≥300 V	-20...+60 °C

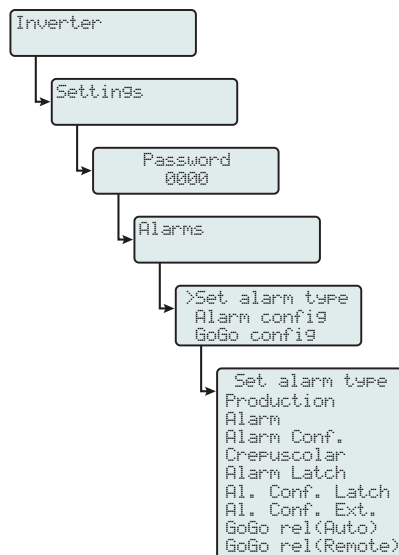

This contact can be used in different operating configurations that can be selected by accessing the specific section of internal webserver (refer to the specific chapter) or in the dedicated display menu (see side picture).

Closing the front cover

At the end of the inverter connection and configuration stage and before proceeding with the commissioning, the inverter's covers ④ and the wiring box covers ⑤ must be closed.

During the installation of the cover, the installation sequence must be respected as well as the tightening torque of the screws (set out in the paragraph on technical data) in order to maintain NEMA Type 4X enclosure integrity.

- Insert and screw in the fixing screws.
- Tighten the screws respecting the sequence and the tightening torque (2.5 Nm / 1.8 ft-lb).

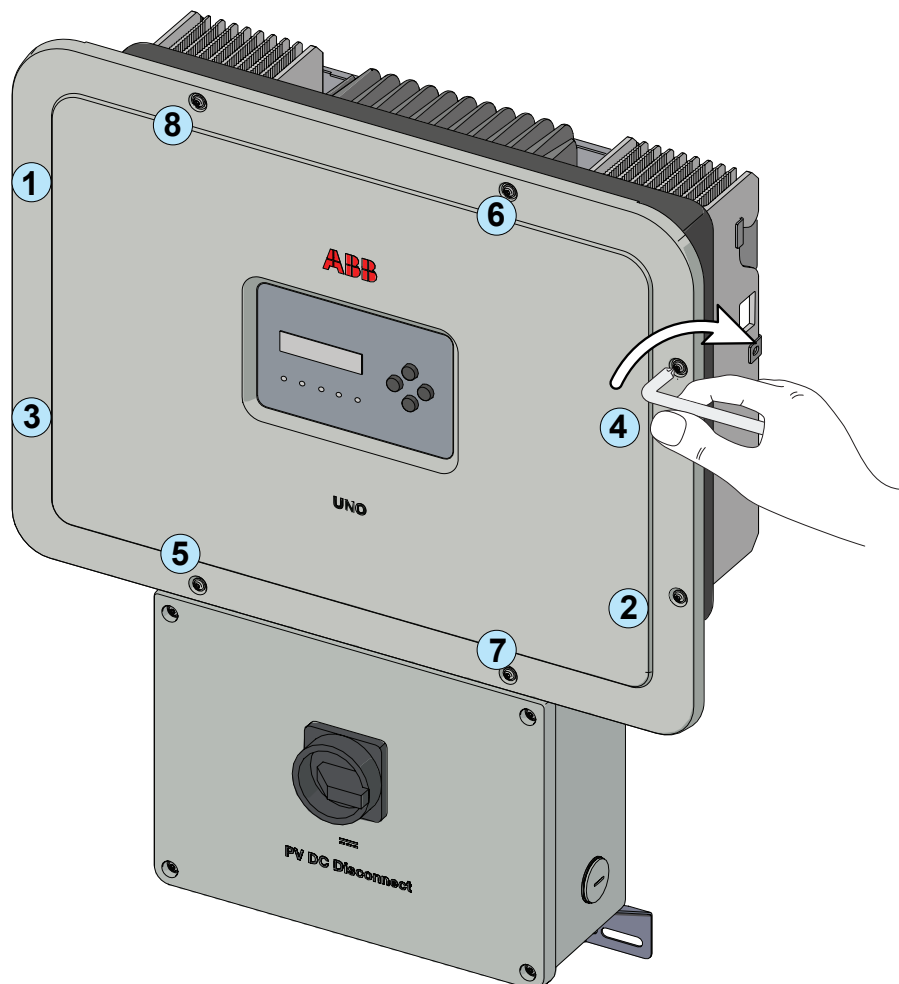

After having installed the front cover, it is possible to proceed with the commissioning of the inverter.

Instruments

6

To prevent damage to the equipment and to the operator is to have a thorough knowledge of the inverter instruments. We, therefore, advise to carefully read this manual; in case of uncertainty on the information to request more detailed information.

The ABB solar inverter help desk may be reached at 1-877-261-1374, 6am - 6pm (PST) Monday-Friday, excluding major holidays.



Do not use the inverter or the PV plant if the operator:

- is not trained or qualified to work on this PV plant;*
- does not understand how the system works;*
- is not sure what will happen when the buttons or switches are operated;*
- notices any operating anomalies;*
- has doubts based on his/her experience, the product manual and/or information from other operators.*

ABB cannot be held responsible for damage to the equipment or the operator resulting from lack of knowledge, insufficient qualifications or lack of training.

Description of keyboard and LED Panel

Using the combination of the keyboard keys below the display, values can be set or data can be viewed by scrolling.

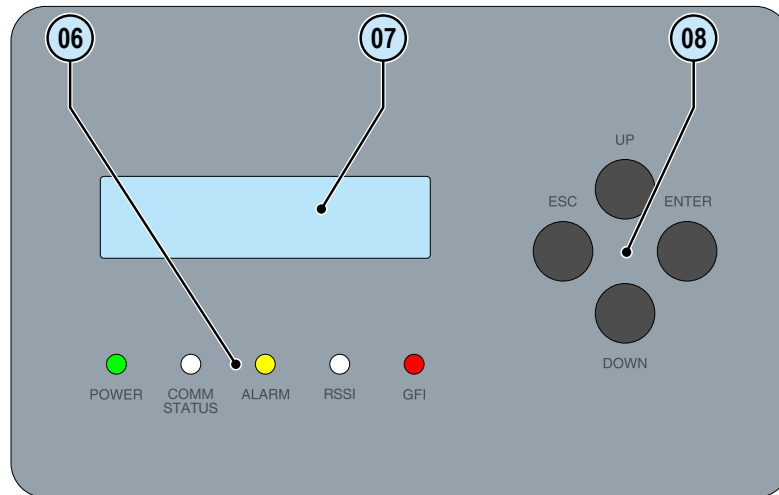

LED	Description
POWER (GREEN)	On if the inverter is working correctly. Flashes when checking the grid or if there is insufficient sunlight.
COMM STATUS (MULTICOLOR)	Operation status of wireless communication line: Blink Red: Communication error (no communication available) Green: Communication OK
ALARM (YELLOW)	The inverter has detected an anomaly. The anomaly is shown on the display.
RSSI (MULTICOLOR)	Communication type and quality of the wireless communication signal (for "Station Mode"): Blink Blue: Wireless board is working in Access Point mode (AP Mode) OFF: No signal Blink Red: Low signal strength Blink Yellow: Medium signal strength Blink Green: High signal strength
GFI (RED)	Ground fault on the DC side of the PV generator. The error is shown on the display.

The LEDs, in various multiple available combinations, can signal multiple conditions other than the original single condition; see the various descriptions explained in the manual.

Button	Description
ESC	It is used to access the main menu in order to go back to the previous menu or to go back to the previous digit to be edited.
UP	It is used to scroll up the menu options or to scroll through the numerical scale in ascending order.
DOWN	It is used to scroll down the menu options or to scroll through the numerical scale in descending order.
ENTER	It can be used to confirm an action, to access the main menu or the submenu for the selected option (indicated by the > symbol) or to switch to the next digit to be edited. When the ENTER key is pressed, cyclic display of the parameters can be: Blocked or Cyclical .

The Keys, in various multiple available combinations, allow you to access actions other than the original single action; see the various descriptions explained in the manual.

Introduction and operation warnings

Before commissioning the inverter, it is necessary to have a thorough knowledge of the Instruments chapter 6 and the functions that is possible to enable in the commissioning phase.

When the inverter is commissioned operates automatically without the aid of an operator; the operating state should be controlled through the equipment's instrumentation (LED's, Aurora Manager LITE).



The input voltage must not exceed the maximum values shown in the technical data, section 2 in order to avoid damaging the equipment.

Monitoring and data transmission

User interface

The inverter is able to provide information about its operation through the following instruments:

- Warning lights (luminous LEDs)
- LCD display showing operating data
- Mobile app and webservice
- Data transmission on the dedicated RS-485 serial line. The data can be collected by a PC or a data logger equipped with an RS-485 port. Contact the ABB support service with any queries about device compatibility.

Measurement tolerance

The data supplied by the inverter may differ from measurements taken by certified measuring instruments (e.g. output meters, multimeters and grid analysers); since the inverter is not a measuring instrument it has wider tolerances for the measurements it makes.

The tolerances are generally:

$\pm 5\%$ for real-time measurements with output power below 20%

$\pm 3\%$ for real-time measurements with output power above 20%

$\pm 4\%$ for all statistical data.



Commissioning (Via internal Webserver)



Do not place objects of any kind on the inverter during operation! Do not touch the heat sink while the inverter is operating! Some parts may be very hot and could cause burns.



Before proceeding with commissioning, make sure you have carried out all the checks and verifications indicated in the section on preliminary checks.



The screenshots shown in this chapter are indicative and it could be changed without any notification.

Commissioning could be carried out via wireless connection to the inverter's internal webserver. Initial setup of the system must therefore be carried out via a tablet, notebook or smartphone with a wireless connection.

- Close the DC disconnect switch to supply the inverter with input voltage from the photovoltaic generator.



The inverter is powered SOLELY by the voltage generated by the photovoltaic generator: the presence of grid voltage alone is NOT SUFFICIENT for the inverter to switch on.



NOTE: If a RSD device was installed into the plant, it also will needed to connect the AC grid to allow the inverter to power-up!



Make sure irradiation is stable and adequate for the inverter commissioning procedure to be completed.

- Set the external AC disconnect switch downstream to the inverter to "ON" position.
- Once powered, the inverter will automatically create a wireless network (approx. 60 seconds after its switch-on) that will be visible as an Access Point from the user devices previously mentioned (tablet, smartphone, etc.).
- Enable the wireless connection on the device which is being used for the board setup (tablet, smartphone or PC) and connect it to the Access Point created by the inverter system: the name of the wireless network created by the system that the connection should be established with, will be:

ABB-XX-XX-XX-XX-XX-XX

where "X" is a hex digit of the wireless MAC address (MAC address can be found on the "Wireless Identification Label" placed on the side of the inverter or applied during the commissioning phase to the quick installation guide on cover page).



The screens shown below pertain to a tablet with the Android operating system. Screens on other devices or operating systems may differ.



- When required digit the network password **ABBSOLAR**



After 24 hours with the inverter is power-on, the access point default password “ABBSOLAR” will be disabled and any subsequent access to the internal webserver will be possible only using the **PRODUCT KEY** (printed on the “Wireless identification label” and applied during the commissioning phase to the quick installation guide on cover page) as access point password.

- Open an internet browser (reccomended browser: Chrome versions from v.55, Firefox versions from v.50) and enter the pre-set IP address **192.168.117.1** to access the setup pages (web user interface). A guided setup procedure will open that will enable you to impose the necessary settings for correct commissioning of the inverter.



The language of the wizard could be changed by clicking on the upper status bar

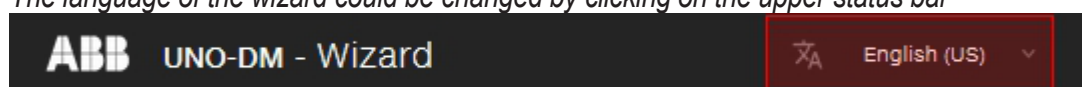

The required informations during the procedure are:

STEP 1 - Administrator/User login credentials

- Set the **Administrator** account user and password (minimum 8 character for password): Administrator account can open and view the contents of photovoltaic site. Additionally, they can make changes to inverter settings. User and password are CASE SENSITIVE.

- Set the **User** account user and (optional) password (minimum 8 character for password): User account can only read data. It cannot make any changes. User and password are CASE SENSITIVE.

STEP 2 (Optional) - Residential wireless network connection.

The inverter WLAN board can operate in two different operating modes: “Station Mode” or “Access Point Mode” (also known as “AP Mode”)

- “AP mode”: Only local communication is enabled in this mode; In particular, the WLAN board acts like an «access point» generating a wireless network to which the user can connect locally, to monitor or configure the inverter / photovoltaic system, using the direct access to the Internal Webserver integrated in the WLAN board

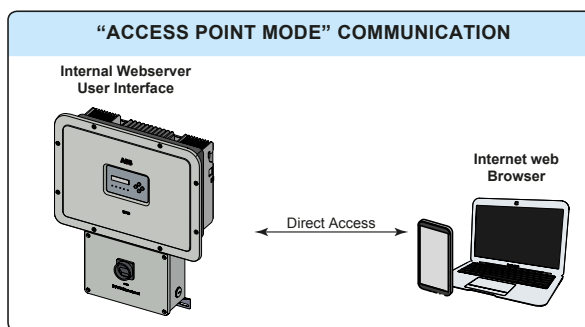

- “Station Mode”: In this operating mode, not only local but also remote monitoring is enabled through access to the LAN connection or through the Aurora Vision® CLOUD platform.

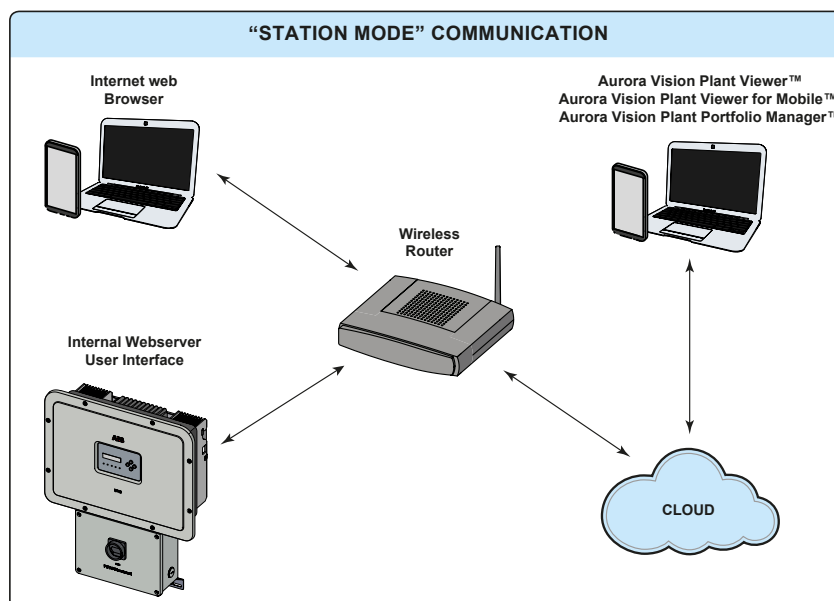

Where possible, “Station Mode” is always preferable. Thanks to the internet connection, this mode ensures better operation.

This setup stage relates to connecting the inverter to the own residential wireless network.

If it is not possible to connect the inverter to the wireless network, or you do not want to do so, select the “Skip this step” button. In this situation, communication between the inverter and the tablet/smartphone/PC will continue to be point to point (“AP Mode”).

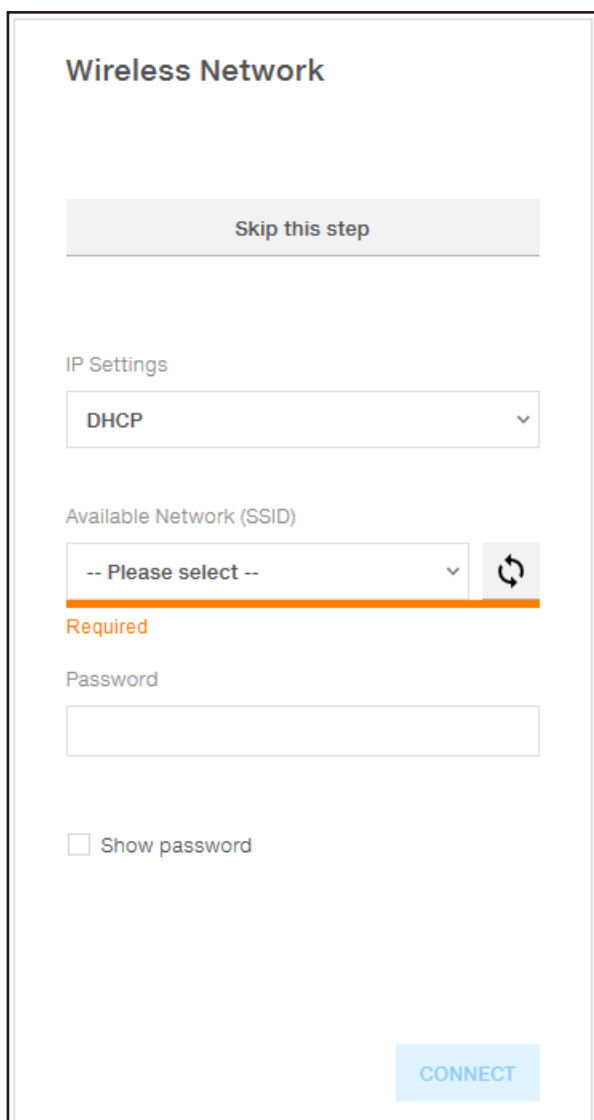

Wireless Network

Skip this step

IP Settings

DHCP

Available Network (SSID)

-- Please select --

Required

Password

Show password

CONNECT

The parameters relating to the home wireless network (set on the router) that must be known and set during this step are:

- IP Settings: DHCP or Static.

If you select the DHCP function (default setup) the router will automatically assign a dynamic IP address to the inverter whenever it tries to connect to the user network.

With Static, the user can assign a fixed IP address to the system. The data which has to be entered in order for IP static address assigning to take place will appear. Complete the additional fields at the bottom of the screen (all the fields are mandatory with the exception of the secondary DNS server).

- Available networks (SSID):

Identify and select your own (home) wireless network from all those shown in the SSID field (you can carry out a new search of the networks that can be detected with the Update button ).

Once the network has been selected, confirm.

- Password: Wireless network password.

Enter the password for the destination network (if necessary) and start the connection attempt (it will take a few seconds).

Click on "Connect" button to switch the inverter wireless connection from point to point to the home wireless network.

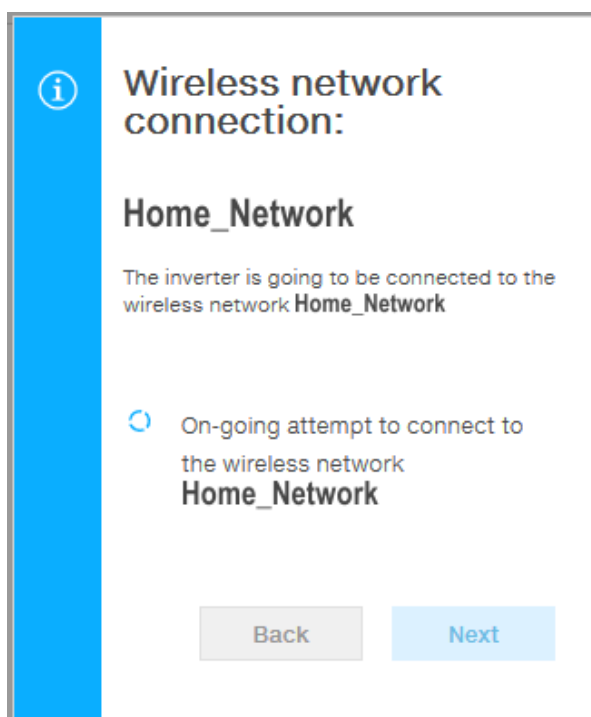

Wireless network connection:

Home_Network

The inverter is going to be connected to the wireless network **Home_Network**

On-going attempt to connect to the wireless network **Home_Network**

Back Next

A message will ask for confirmation. Click "Next" to connect the inverter to the home wireless network.

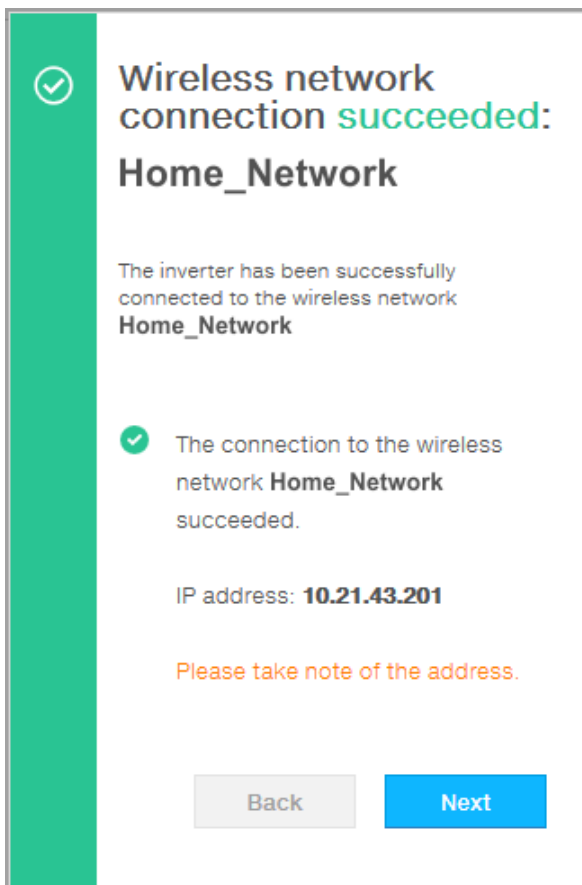

Once the inverter is connected to the domestic wireless network, a new message will confirm that the connection is acquired.

The message provides the IP Address assigned by the home wireless network router to the inverter that can be used each time you want to access the internal webserver, with the inverter connected to the home wireless network. **Take note of it.**

Click on “Next” button to proceed to the next stage of the configuration wizard.



The IP address assigned may vary for reasons connected to the wireless home router setup (for example, a very brief DHCP lease time). If verification of the address is required, it is usually possible to obtain the client list (and the corresponding IP addresses) from the wireless router administration panel.



If the inverter loses the connection with the home wireless network (and therefore, loses the internet connection), it will once again enable its own access point.



The most common causes of losing connectivity might be: different wireless network password, faulty or unreachable router, replacement of router (different SSID) without the necessary setting updates.

STEP 3 - Date, Time and Time zone

Date and Time

✔ Network Time Protocol server has been detected and it will be used to keep the system clock synchronized.

Date ●

Feb 22, 2017

SET by the NTP server

Time ●

3:28 PM

SET by the NTP server

Time Zone

Europe/Berlin GMT+01:00

BACK NEXT

Set the Date, Time and Time zone (The inverter will propose these fields when available).

Date and Time

⊙ Network Time Protocol server has not been detected. Clock isn't synchronized. The displayed date and time come from the inverter or have been manually set up.

Please set the correct system date and time if needed.

Date and time will be automatically updated as soon as an NTP server is available.

Date

2/8/17

Time

11 : 56 AM

Time Zone

Europe/Berlin GMT+01:00

BACK NEXT

When it's not possible for the inverter to detect the time protocol, these fields have to be manually entered.

Click on "Next" button to proceed to the next stage of the configuration wizard.

STEP 4 - Inverter country standard, Input configuration and Meter configuration

- Country standard: selection of grid standard:

Set the grid standard of the country in which the inverter is installed.



From the moment that the grid standard is set, you have 24 hours to make any changes to the value, after which the “Country Select > Set Std.” functionality is blocked, and the remaining time will have to be reset in order to have the 24 hours of operation available again in which to select a new grid standard (follow the procedure “Resetting the remaining time for grid standard variation” described in the relevant section).



Any inverters installed, or commissioned, in California after September 8, 2017 must be set to the Rule 21 country code USA - RULE21 @ 240 single [R21 240sp] or USA - RULE21 @ 208 single [R21 208sj].

Country standard

Grid Standard

-- Please select --

Required

Input mode

PV Input Channels Configuration

Independent

Meter

Meter Model

none

BACK
END

- Input mode:

(See the relevant section of this manual to know how set the input mode)

1. **Independent**
2. **Parallel**

- Meter:

Select None. No UL certified meter are available at the moment.

Saving parameters

① After country standard is changed the inverter will be rebooted. The procedure may take several minutes. Please wait.

BACK
END

Confirm the settings by clicking “END” and it will reboot at the finish of test phase.

A notification will confirm that the wizard is completed.

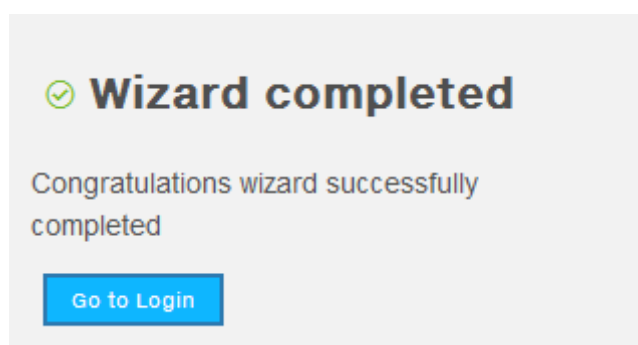

• After the wizard is completed, the message “Initializing...Please Wait” is displayed on the inverter display. Regardless of the input voltage value, the inverter displays various messages and changes the behaviour of the “Power” and “Alarm” LEDs ^⑥:

Input voltage	Message on display	LED Status	Description
Vin < Vstart	Waiting Sun	Power = Flashing Alarm = OFF	The input voltage is not sufficient to enable connection to the grid.
Vin > Vstart	Missing Grid	Power = Flashing Alarm = ON	The input voltage is sufficient to enable connection to the grid: the inverter waits for the grid voltage to be present to make the parallel connection.



The inverter is powered SOLELY by the voltage generated by the photovoltaic generator: the presence of grid voltage alone is NOT SUFFICIENT for the inverter to switch on.



Once both AC and DC switches are closed and the wizard commissioning procedure is finished, the inverter starts the grid connection sequence: the inverter performs the grid voltage check, measures the PV array insulation resistance against earth and carries out other self-diagnosis checks. During the preliminary checks on the parallel connection with the grid, the “Power” LED keeps flashing, the “Alarm” and “GFI” LEDs are off.

- During the check on the grid voltage and the measurement of the insulation resistance, the voltage, grid frequency and insulation resistance values measured by the inverter are displayed. The inverter ONLY creates a parallel connection with the grid if the grid and insulation resistance parameters fall within the ranges foreseen by current regulations.
- If the outcome of the preliminary checks on the grid parallel is positive, the inverter connects to the grid and starts to export power to the grid. The “Power” LED remains fixed on while the “Alarm” and “GFI” LEDs are off.



To address any problems that may occur during the initial stages of operation of the system and to ensure the inverter remains fully functional, you are advised to check for any firmware updates in the download area of the website www.abb.com/solarinverters (instructions for updating the firmware are given in this manual).

Commissioning (Using the inverter display)



Do not place objects of any kind on the inverter during operation! Do not touch the heat sink while the inverter is operating! Some parts may be very hot and could cause burns.



Before proceeding with commissioning, make sure you have carried out all the checks and verifications indicated in the section on preliminary checks.

The procedure for commissioning the inverter consists of the following steps:

- Close the DC disconnect switch to supply the inverter with the photovoltaic generator voltage. If the inverter is equipped with a DC disconnect switch, set the DC disconnect switch  to the ON position.



The inverter is powered SOLELY by the voltage generated by the photovoltaic generator: the presence of grid voltage alone is NOT SUFFICIENT for the inverter to switch on.



NOTE: If a RSD device was installed into the plant, it also will need to be connected to the AC grid to allow the inverter to power-up!



Make sure irradiation is stable and adequate for the inverter commissioning procedure to be completed.

```
Config. Wizard
ENTER to START
```

ENTER

```
Time hh:mm
Date DD MMM YYYY
```

ENTER

```
INPUT MODE
Independent
```

ENTER

```
GRID=Xxxxxxxx
Lang=Xxxxxxxx
```

- Set the external AC disconnect switch downstream to the inverter to “ON” position.

- When the inverter is connected to the power supply, the display will show a guided configuration procedure and the yellow ALARM led is fast blinking. Press ENTER to set the following:

- Inverter date and time
- Selection of the current input mode: Independent or Parallel (See the relevant section of this manual to know how to set the proper input mode)
- Selection of grid standard and corresponding display language.



For the list of available grid standards and the relative details, contact ABB Technical Sales (1-877-261-1374).



From the moment that the grid standard is set, you have 24 hours to make any changes to the value, after which the “Settings > Country Select > Set Std.” functionality is blocked, and the remaining time will have to be reset in order to have the 24 hours of operation available again in which to select a new grid standard (follow the procedure “Resetting the remaining time for grid standard variation” described in the relevant section).

- After having set the Country Standard (grid standard), the message "Initializing...Please Wait" is displayed. Regardless of the input voltage value, the inverter displays various messages and changes the behaviour of the "Power" and "Alarm" LEDs :

Input voltage	Message on display	LED Status	Description
$V_{in} < V_{start}$	Waiting Sun	Power = Flashing Alarm = OFF	The input voltage is not sufficient to enable connection to the grid.
$V_{in} > V_{start}$	Missing Grid	Power = Flashing Alarm = ON	The input voltage is sufficient to enable connection to the grid: the inverter waits for the grid voltage to be present to make the parallel connection.

Once both AC and DC switches are closed the inverter starts the grid connection sequence: the inverter performs the grid voltage check, measures the PV array insulation resistance against earth and carries out other self-diagnosis checks. During the preliminary checks on the parallel connection with the grid, the "Power" LED keeps flashing, the "Alarm" and "GFI" LEDs are off.





- During the check on the grid voltage and the measurement of the insulation resistance, the voltage, grid frequency and insulation resistance values measured by the inverter are displayed. The inverter ONLY creates a parallel connection with the grid if the grid and insulation resistance parameters fall within the ranges foreseen by current regulations.
- If the outcome of the preliminary checks on the grid parallel is positive, the inverter connects to the grid and starts to export power to the grid. The "Power" LED remains fixed on while the "Alarm" and "GFI" LEDs are off.



























To address any problems that may occur during the initial stages of operation of the system and to ensure the inverter remains fully functional, you are advised to check for any firmware updates in the download area of the website www.abb.com/solarinverters (instructions for updating the firmware are given in this manual).

Power, Alarm, GFI LEDs behavior

The following table shows all the possible activation combinations of “Power” “Alarm” and “GFI” LEDs on the LED panel  according to the operating status of the inverter.

-  = LED On
-  = LED flashing
-  = LED Off
-  = Anyone of the conditions described above

LED status	Operating state
Power:  Alarm:  GFI: 	Firmware programming The inverter firmware is being programmed
Power:  Alarm:  GFI: 	Night mode (inverter automatically switches off) The inverter is in night time switch-off mode (input voltage less than 70% of the set start-up voltage).
Power:  Alarm:  GFI: 	Inverter initialisation This is a transitional state due to the verification of the operating conditions. During this stage the inverter checks that the conditions for connecting to the grid are met.
Power:  Alarm:  GFI: 	The inverter is connected and is feeding power into the grid Normal operation. During this stage, the inverter automatically tracks and analyses the photovoltaic generator's maximum power point (MPP).
Power:  Alarm:  GFI: 	Disconnection from the grid Indicates no grid voltage. This condition does not allow the inverter to connect to the grid (the inverter display shows the message "Missing Grid").
Power:  Alarm:  GFI: 	Indication of Warning (W message codes) or Error (E message codes) Indicates that the inverter control system has detected a warning (W) or error (E). The display shows a message indicating the type of problem found (see Alarm messages).
	<ul style="list-style-type: none"> • Ventilation anomaly Indicates an anomaly in the operation of the internal ventilation system that could limit output power at high ambient temperatures.
	<ul style="list-style-type: none"> • Failed association of internal inverter components (after replacement) Indicates that the installed wiring box (only in the event of a replacement) was already associated with another inverter and cannot be associated with the new inverter
Power:  Alarm:  GFI: 	<ul style="list-style-type: none"> • Overvoltage surge arresters triggered (where fitted) Indicates that any class II overvoltage surge arresters installed on the AC or DC side have been triggered
	<ul style="list-style-type: none"> • String protection fuses triggered (where fitted) Indicates that one or more input string protection fuses that may be installed have been triggered
	<ul style="list-style-type: none"> • Autotest (for Italian grid standards only) The inverter is performing an Autotest
Power:  Alarm:  GFI: 	Anomaly in the insulation system of the photovoltaic generator Indicates that a leakage to ground from the PV generator has been detected, causing the inverter to disconnect from the grid.



Specifications on operation of the LEDs

In correspondence to each status of the inverter indicated by the constant or intermittent lighting of the specific LED, the display ⑦ also shows a message identifying the operation which is being carried out or the defect/anomaly recorded (see specific chapter).



In the case of malfunction it is extremely dangerous to intervene personally to try and eliminate the defect. The instructions below must be followed scrupulously; if you do not have the necessary experience and training to intervene safely, please contact a specialist.

LED insulation fault

Interventions after warning of insulation fault

When the GFI LED comes on, first try to reset the warning by pressing the multi-function ESC button on the keyboard ⑧.
Should the inverter reconnect normally to the grid, the fault was due to temporary phenomena.



You are advised to have the plant inspected by the installer or a specialist should this malfunction occur repeatedly.

Should the inverter not reconnect to the grid, isolate it on both the AC and DC sides (by using the disconnect switches), then contact the installer or authorised center to repair the fault in the photovoltaic generator.



COMM Status, RSSI LEDs behavior

The following table shows all the possible status of “COMM Status” and “RSSI” LEDs on the LED panel ⑥ according to the operating status of the wireless board.

LED	Description
COMM STATUS (MULTICOLOR)	Operation status of wireless communication line: Blink Red: Communication error (no communication available) Green: Communication OK
RSSI (MULTICOLOR)	Communication type and quality of the wireless communication signal (for “Station Mode”): Blink Blue: Wireless board is working in Access Point mode (AP Mode) OFF: No signal Blink Red: Low signal strength Blink Yellow: Medium signal strength Blink Green: High signal strength

Description of the internal Webserver

The UNO-DM-TL-PLUS inverters are equipped with an advanced integrated webserver and user interface that allow a full access to all configuration and commissioning parameters from any electronic device (laptop, tablet and smartphone).



The screenshots shown in this chapter are indicatives and it could be changed without any notification.

Access to the internal Webserver

To access to the internal webserver is required to connect a device equipped with wireless connection (such as tablet, laptop or smartphone).

Depending on the connection method chosen during the inverter commissioning phase (“Station Mode” or “AP Mode”) it’s required to follow one of the two procedures described below:

Connection to the inverter in “Station Mode”

- Enable the wireless connection on the device (tablet, smartphone or laptop) and connect it to the same wireless network to which the inverter is connected.
- Open an internet browser (recommened browser: Chrome versions from v.55, Firefox versions from v.50) and enter the links (corresponding to the IP Address assigned by the router to the inverter, or the “Host Name”) provided during the commissioning phase to access the login page.



In order to use the “Host Name” as an alternative to the dynamic IP address, the Wi-Fi router to which the board is connected (when operating in “Station Mode”) must provide the Domain Name System (DNS) service (contact the network administrator for further information regarding the presence or absence of the DNS service in the Wi-Fi router or how to enable it). In this way, even if the IP address assigned to the inverter should change over time, (dynamic IP), it will always be possible to use the same “Host Name” which will remain unchanged over time.



The IP address assigned may vary for reasons connected to the wireless home router setup (for example, a very brief DHCP lease time). If verification of the address is required, it is usually possible to obtain the client list (and the corresponding IP addresses) from the wireless router administration panel.

If the “Host Name” was lost, it could be obtained writing this url:

<http://ABB-XX-XX-XX-XX-XX-XX.local>



replacing the “X” with the hex digits of the wireless MAC address of the inverter (it can be found on the “Wireless Identification Label” placed on the side of the inverter or applied during the commissioning phase to the quick installation guide on cover page).

Connection to the inverter in “AP Mode”

- Enable the wireless connection on the device which is being used for the board setup (tablet, smartphone or PC) and connect it to the Access Point created by the inverter system: the name of the wireless network created by the system that the connection should be established with, will be:

ABB-XX-XX-XX-XX-XX-XX

where “X” is a hex digit of the wireless MAC address (MAC address can be found on the “Wireless Identification Label” placed on the side of the inverter or applied during the commissioning phase to the quick installation guide on cover page).

- When required digit the network password **ABBSOLAR**



After 24 hours wick the inverter is power-on, the access point default password “ABBSOLAR” will be disabled and any subsequent access to the internal webserver will be possible only using the PRODUCT KEY (printed on the “Wireless identification label” and applied during the commissioning phase to the quick installation guide on cover page) as access point password.

- Open an internet browser (reccomended browser: Chrome versions from v.55, Firefox versions from v.50) and enter the pre-set IP address **192.168.117.1** to access the login page.



Login page

After you have connected the device to the inverter and you access to the login page, login with the username and password created during the commissioning phase.



User and password are CASE SENSITIVE.



If the Password is lost click on “Forgot your password?” to obtain the access to the webserver (and it will be possible to change the password) by entering the PRODUCT KEY (printed on the “Wireless identification label” and applied during the commissioning phase to the quick installation guide on cover page).



The language of the internal webserver could be changed in any moment by clicking on the right status bar:

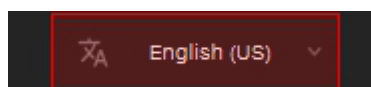

Webserver menu structure



The following screenshots are related from a laptop visualization, may differ from smartphone or tablet visualization.

The Webserver is divided in six main sections, available on the left sidebar:

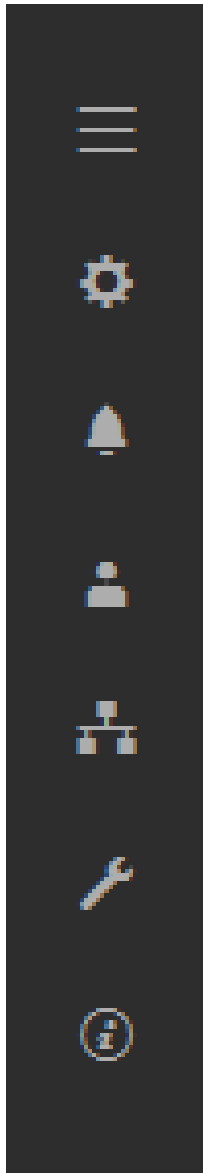

MAIN: Main section of webserver dedicated to viewing the summary informations related the status and the production informations of the inverter and photovoltaic plant.

SETUP: Section dedicated to AC and DC line parameters configurations.

EVENTS: Section dedicated to viewing Alarms and Warnings event log.

USER: Section dedicated to User management.

NETWORK: Section dedicated to inverter communication settings and configurations.

TOOLS: Section dedicated to main service tools configurations.

INFORMATION: Section dedicated for general informations about the embedded webserver.

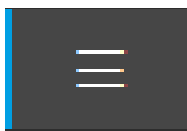

MAIN section

In the **MAIN** section it's possible to access the following sub-menus:

- **Dashboard**
- **Status Summary**

Dashboard

In the **Dashboard** sub-menu you can view the main informations related the status and the production informations of the inverter and photovoltaic plant and alarm/warning active events.

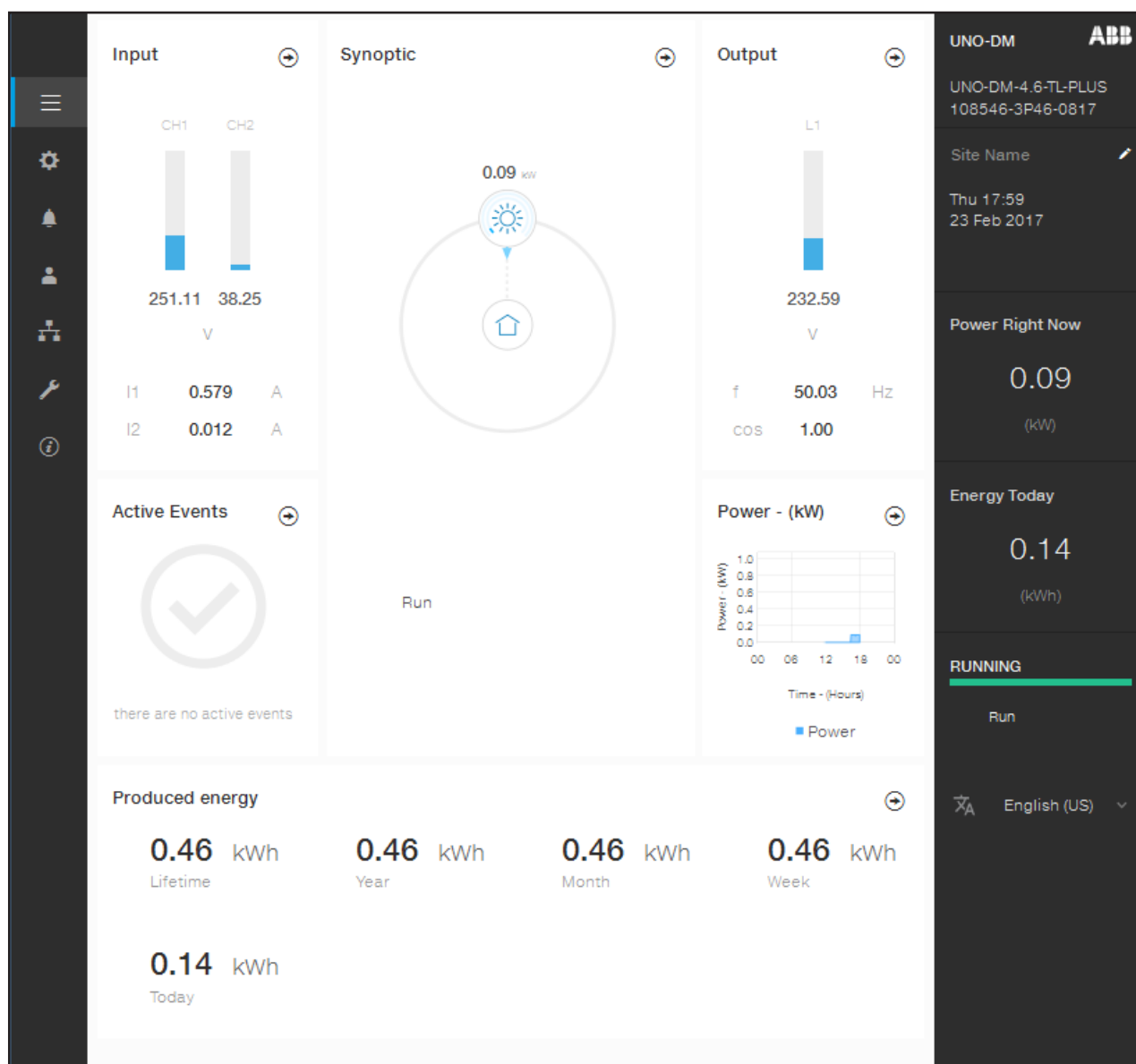

Status Summary

In the **Status Summary** sub-menu you can view the detailed informations related the status and the production informations of the system.

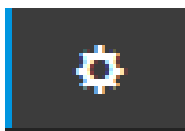

SETUP section

In the **SETUP** section it's possible to access the following sub-menus:

- **Setup DC Side**
- **Setup AC Side**

Setup DC Side

In the **Setup DC Side** sub-menu you can setup the parameter related to the Input DC side:

1. VStart1

This parameter is used to set the Vstart activation voltage for the input channel 1 if they are configured independently (If parallel you will see only a single "Vstart" parameter for both channels). This voltage imposes a minimum input voltage on the inverter above which connection to the grid will be attempted.

2. VStart2

This parameter is used to set the Vstart activation voltage for the input channel 2 if they are configured independently (If parallel you will see only a single "Vstart" parameter for both channels). This voltage imposes a minimum input voltage on the inverter above which connection to the grid will be attempted.

We advise changing the activation voltage only if really necessary and to set it to the correct value: the photovoltaic generator sizing tool available on the ABB website will indicate whether Vstart needs changing and what value to set it to.

3. Input Mode

This settings allows you to set the input configuration mode.
In particular:

- **Independent:** Independent configuration of the two input channels. This configuration is set by default.
- **Parallel:** Parallel configuration of the input channels (single input channel). Other hardware settings must be set on the inverter to set this mode. Refer to the paragraph "Parallel channel configuration".

4. UV Protection Time

This section of the menu allows you to set the time for which the inverter stays connected to the grid after the input voltage has dropped below the Under Voltage limit (set at 70% of Vstart).

This value can be set from 1 to 3600 seconds (60 seconds is the default setting).



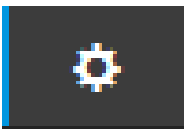

5. Multiple Max Scan Enable

This settings allows you to Enables/disables the scan for identifying the maximum power point of the system.

6. Multiple Max Scan Period

This settings allows you to set the time between scans. Remember that the shorter the scan interval the greater the loss of production, due to the fact that energy is transferred to the grid during the scan but not at the maximum power point. Each scan takes roughly 2 seconds..

7. MPPT Noise amplitude

By changing this settings you can choose the amplitude of the DC perturbation introduced to establish the optimal operating point.

Setup AC Side

In the **Setup AC Side** sub-menu you can setup the parameter related to the Output AC side:



Changing the above-mentioned parameters may prevent disconnection from the grid if the new values exceed those given in the standards of the country of installation. If these parameters are changed to values outside the standard range, an interface protection must be installed external to the inverter in accordance with the requirements of the country of installation.



1. Grid Protection

By editing these settings it's possible to enable/disable and change the grid protection intervention thresholds parameters.

2. Grid Connection

By editing these settings it's possible to change the grid connection thresholds parameters to which the inverter have to connect to the grid.

3. High Frequency Derating

By setting these parameters it's possible to change the output derating behavior of the inverter related to the grid frequency parameters.

4. Setup Average Vgrid Derating

By setting these parameters it's possible to change the output derating behavior of the inverter related to the average voltage parameters of the grid.

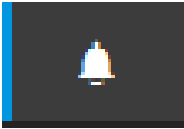

EVENTS Section

In the **EVENTS** Section it's possible to view the Alarm and Warning events list that it can be custom filtered by type or by entering a matching word.

Clicking on any event to view his details.

Alarm History

CLEAR FILTERS
REFRESH EVENTS

All
Fault
Warnings
Info

⏪
⏩
1 of 1
⏪
⏩

Origin: inverter 23/02/2017 16:23:56 ⚠ W004 WARNING (CLOSED) AC GRID OVERVOLTAGE
Origin: inverter 22/02/2017 19:01:11 ⚠ W007 WARNING (CLOSED) AC GRID UNDERFREQUENCY
Origin: inverter 22/02/2017 18:32:06 ⚠ W022 WARNING (CLOSED) REACT POWER MODE CHANGED
Origin: inverter 22/02/2017 17:10:06 ⚠ W006 WARNING (CLOSED) AC GRID OVERFREQUENCY
Origin: inverter 22/02/2017 16:23:56 ⚠ W006 WARNING (CLOSED) AC GRID OVERFREQUENCY

Event Details

Event Description

AC grid overvoltage - W004 - WARNING



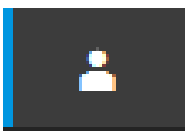

USER section

In the **USER** section it's possible to logout from webserver and return to the login page, or to access the following sub-menus:

- **Edit Email and Password**
- **Admin Plus**
- **User Management**

Edit Email and Password

In the **Edit Email and Password** sub-menu you can change the e-mail and password related to the user which is used to login to the web-server:

Admin Plus

By accessing to the **Admin Plus** sub-menu you can obtain the “Admin Plus” user privileges which allow you to change the grid standard of the inverter, after 24 hours while the inverter is operating, and the **Country Standard** sub-menu on **TOOLS** section is locked.

To access on the internal webserver with the “Admin Plus” user privileges it's required to enter a security token that it can be obtained by contacting ABB Technical Sales (1-877-261-1374). Refer to the dedicated section on this topic in the manual.



User Management

By accessing to the **User Management** sub-menu it's possible to edit all the users already created and create new users (both with admin or User privileges).

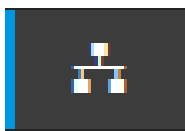

NETWORK section

In the **NETWORK** section it's possible to access the following sub-menus:

- **RS485**
- **WLAN Status**
- **Modbus TCP**
- **Debug Settings**

RS485

In the **RS485** sub-menu it's possible to adjust the settings relating to the RS485 communication serial line:

- **RS485 Node Address**: It allows you to set the address for serial communication of the individual inverters connected to the RS485 line. The UP and DOWN buttons scroll through the numerical scale. (The addresses that can be assigned are 2 to 63).
- **RS485 Baud Rate**: It allows you to set the Baud Rate (2400/4800/9600/19200/34800/57600/115200).
- **RS485 Protocol Type**: It allows you to set the type of protocol to be used for the RS485 line.
 - "Protocol Aurora Server": it's the proprietary ABB serial protocol usually used for back-compatibility or by service personell.
 - "Modbus Sunspec Server": General purpose communication protocol to be selected to enable monitoring and control.
 - **RS485 Parity Mode**: It allows you to set the Parity bit (No Parity, Even Parity, Odd Parity).



WLAN Status

In the **WLAN Status** sub-menu it's possible to view the address of the wireless board of the inverter, and to switch between the two operation mode ("Station Mode" or "AP Mode").

- "AP mode": Only local communication is enabled in this mode; In particular, the WLAN board acts like an «access point» generating a wireless network to which the user can connect locally, to monitor or configure the inverter / photovoltaic system, using the direct access to the Internal Webserver integrated in the WLAN board
- "Station Mode": In this operating mode, not only local but also remote monitoring is enabled through access through the Aurora Vision® CLOUD platform.



Where possible, "Station Mode" is always preferable. Thanks to the internet connection, this mode ensures better operation.





In case of “Station Mode” selection it’s required to enter the wireless network parameters (set on the router) and follow the subsequent procedure:

WLAN Status

Mode: Access Point
 SSID: ABB-60-f1-89-b0-e5-25
 IP: 192.168.117.1

Settings

Access Point Mode Only: **OFF**

IP Settings

DHCP

SSID

HOME_Network

Password

Show password

CONNECT

- IP Selection Mode: DHCP or Static:

If you select the DHCP function (default setup) the router will automatically assign a dynamic IP address to the inverter whenever it tries to connect to the user network.

With Static, the user can assign a fixed IP address to the system. The data which has to be entered in order for IP static address assigning to take place will appear. Complete the additional fields at the bottom of the screen (all the fields are mandatory with the exception of the secondary DNS server).

- SSID (name of wireless network):

Identify and select your own (home) wireless network from all those shown in the SSID field (you can carry out a new search of the networks that can be detected with the Update button). Once the network has been selected, confirm.

- Password (wireless network password):

Enter the password for the destination network (if necessary) and start the connection attempt (it will take a few seconds).

Click on “Connect” button to switch the inverter wireless connection from point to point to the home wireless network.

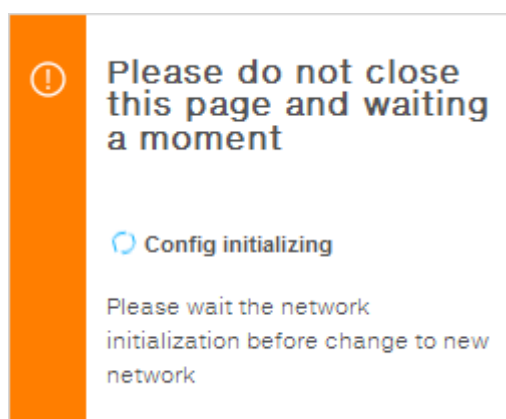



Once the inverter is associated with the domestic wireless network, the user must switch the tablet/smartphone/PC to the same wireless network which the inverter is connected.

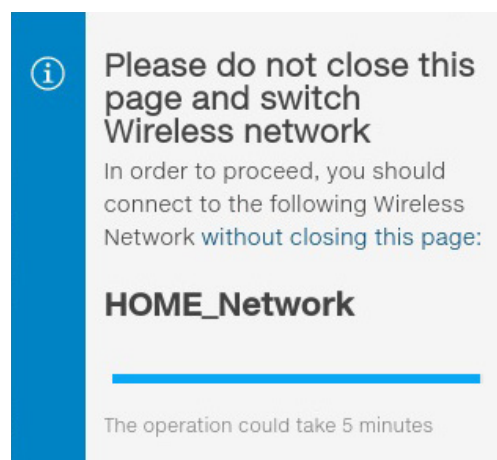

Once the tablet/smartphone/PC device is switched to the domestic wireless network a new message will confirm that the connection is acquired. (the WLAN board automatically disables its access point network with the name ABB-XX-XX-XX-XX-XX-XX that it is no longer necessary).

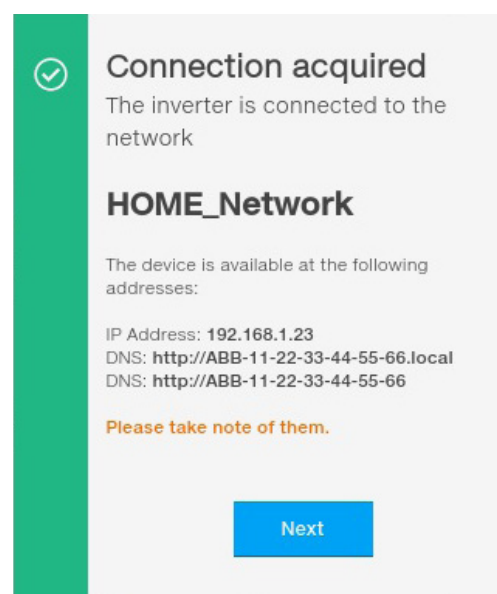

The message provides the links corresponding to the IP Address assigned by the home wireless network router to the inverter and the “Host Name”: both links can be used each time you want to access the internal webserver, with the inverter connected to the home wireless network. **Take note of them.**

Click the “Next” button” to complete the setup of “Station Mode”



In order to use the “Host Name” as an alternative to the dynamic IP address, the Wi-Fi router to which the board is connected (when operating in “Station Mode”) must provide the Domain Name System (DNS) service (contact the network administrator for further information regarding the presence or absence of the DNS service in the Wi-Fi router or how to enable it). In this way, even if the IP address assigned to the inverter should change over time, (dynamic IP), it will always be possible to use the same “Host Name” which will remain unchanged over time.



The IP address assigned may vary for reasons connected to the wireless home router setup (for example, a very brief DHCP lease time). If verification of the address is required, it is usually possible to obtain the client list (and the corresponding IP addresses) from the wireless router administration panel.

If the inverter loses the connection with the home wireless network (and therefore, loses the internet connection), it will once again enable its own access point.



The most common causes of losing connectivity might be: different wireless network password, faulty or unreachable router, replacement of router (different SSID) without the necessary setting updates.



Modbus TCP

In the **Modbus TCP** sub-menu it's possible to enable exchanging of data with third party monitoring and control systems over wireless channel in compliance with Sunspec register map, by setting “ON” the “Modbus TCP Server” parameter.

By changing “Modbus Power Control” parameter settings to “OFF” only reading register is enabled.

Debug Settings

In the **Debug Settings** sub-menu it's possible to enable or disable the Debugging access for ABB Service purposes.

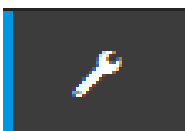

TOOLS section

In the **TOOLS** section it's possible to access the following sub-menus:

- **Dynamic Feed-in Control**
- **Local I/O Manager**
- **Country Standard**
- **Autotest CEI 0-21**
- **Firmware Update**
- **Date/Time**

Dynamic Feed-in Control

In the **Dynamic Feed-in Control** sub-menu it's possible to enable the management of power flows in order to optimize self-consumption or avoid feeding power to the grid (except during transitory), basing on the reading of the energy meter:



No UL meters are available at the moment. The selection of the meter must be "None"

Dynamic Feed-In Control

Meter

Meter Model

ABB B23 3PH
▼

Meter Phase

Phase L1
▼

Energy Policy

Energy Policy

Self consumption
▼

PV Generator Power (Wp)

4650

Feed-In Power (% PV Generator Power)

100

SAVE

- Meter:

When a meter device is connected to the inverter, it's requested to select the meter model:

1. **None** (where system is installed without meter)
2. **REACT-MTR-1PH** (single-phase). Not UL certified.
3. **ABB B23 1PH** (single-phase). Not UL certified.
4. **ABB B23 3PH** (three-phase). Not UL certified.



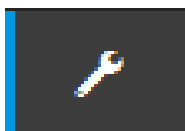

Local I/O Manager

In the **Local I/O Manager** sub-menu it's possible to enable the management of power flows in order to optimize self-consumption or avoid feeding power to the grid (this features will work only on inverter equipped with UNO-DM-COM KIT or UNO-DM-PLUS-Ethernet COM KIT).

This section of the menu allows you to set the activation status of a relay (available either as contact normally open – N.O. - and as a normally closed contact -N.C.) and to configure customised alarm conditions.

This contact can be used, for example, to: activate a siren or a visual alarm, control the disconnect device of an external transformer, or control an external device. A little description of the alarm type (e.g. “alarm lamp”) is required.

Relay switching can be set in 9 different modes using the submenu **Set Alarm Type** (For the “Alarm Conf.”, “Al. Conf. Latch”, “Al. Conf. Ext.”, “GoGo Rel(Auto)” and “GoGo Rel(Slave)” it is possible to configure customised alarm conditions through the submenu **Alarm Config**:

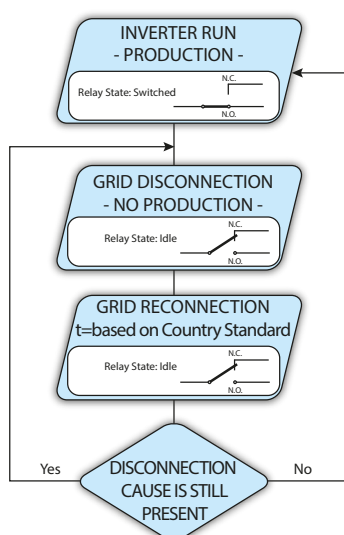

• Alarm Production - display text “Alarm-Contact (Production)”

The relay is activated (status: switched) whenever the inverter connects to the grid; as soon as the inverter is disconnected from the grid (for whatever reason that caused disconnection), the relay is in its resting position.

• Alarm with reset at the end of the alarm signalling process - display text “Alarm-Contact (alarm ALL - no-latch)”:

The relay is activated (status: switched) whenever an error (code Exxx) or warnings related to grid parameters out of range (Warning – codes W003, W004, W005, W006, W007) are present on the inverter. The alarm returns to its resting position when the alarm signal ends, i.e. before the inverter checks the grid parameters after the alarm state. This is because grid control state is not an alarm state but a state of normal operation.

Alarms for which the relay is activated

E001	E002	E003	E004	E005	E006
E007	E010	E011	E012	E013	E014
E015	E016	E017	E018	E019	E020
E021	E022	E023	E025	E026	E027
E028	E029	E030	E031	E032	E033
E034	E035	E036	E037	E046	E050
E051	E053	E054	E055	E056	E057
E058	E065	E066	E067	E068	E069
E070	E074	E077	E078	E080	E084
E086	E087	E088	E089		
W002	W003	W004	W005	W006	W007
W009	W011	W015	W017	W018	W019
W021	W022	W023	W024	W027	W029
W030	W036	W037	W039	W040	W042
W043	W046	W047	W048	W051	W058
W059					

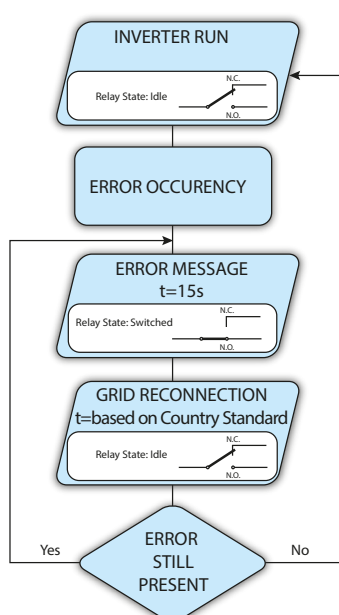

In the presence of W003, W004, W005, W006, W007 signalling, the alarm contact switches to then reset itself at the end of the alarm signal. This means that during the absence of grid voltage (display message “Missing Grid”) the alarm contact remains in its resting position.



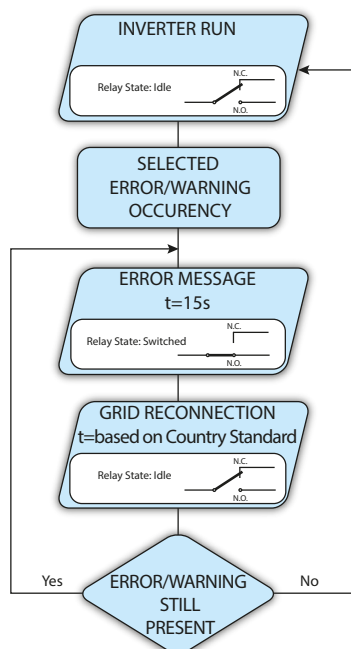
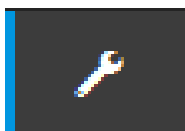

• **Configurable alarm with reset at the end of the alarm signalling process - display text “Alarm-Contact (alarm configurable - no-latch)”**

The relay is activated (status: switched) whenever an error (code Exxx) or a warning (code Wxxx) is present from those selected from the list in the dedicated submenu **Alarm Config** of the inverter display. The contact returns to its resting position when the alarm signal ends, i.e. before the inverter checks the grid after the alarm state. This is because grid control state is not an alarm state but a state of normal operation.

Alarms for which the relay is activated

E001	E002	E003	E004	E005	E006
E007	E010	E011	E012	E013	E014
E015	E016	E018	E019	E020	E021
E022	E023	E025	E026	E027	E028
E029	E030	E031	E032	E033	E034
E036	E037	E046	E050	E051	E053
E054	E055	E056	E057	E058	E065
E066	E067	E068	E069	E070	E074
E077	E078	E080	E084	E086	E087
E088	E089				
W002	W003	W004	W005	W006	W007
W009	W011	W015	W017	W018	W019
W021	W022	W023	W024	W025	W027
W029	W030	W031	W037	W039	W040
W042	W043	W046	W047	W048	W051
W058	W059				

For the configurable relay operating mode “Alarm Conf.”, the following considerations are valid:

If the alarm condition is persistent, the alarm contact cyclically switches from its resting state to its activated state.



In the presence of W002 signalling (Input UV – input voltage below the limit of operation), the alarm contact switches to then reset itself at the end of the alarm signal. This means that during the reduced input voltage (display message “Waiting Sun”) the alarm contact remains in its resting position.

In the presence of W003, W004, W005, W006, W007 signalling, the alarm contact switches to then reset itself at the end of the alarm signal. This means that during the absence of grid voltage (display message “Missing Grid”) the alarm contact remains in its resting position.

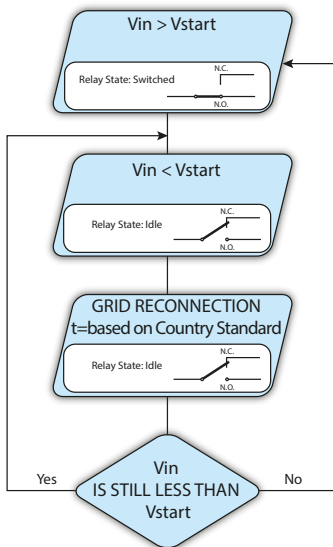

• **Crepuscular - display text “Alarm-Contact (crepuscular)”:**

The relay is activated (status: switched) as soon as the inverter input voltage exceeds the activation voltage set.

The relay switch to rest position when the input voltage drops below 70% of the activation voltage set.

This mode is useful for disconnecting any output transformers that could have unnecessary consumption during the night.

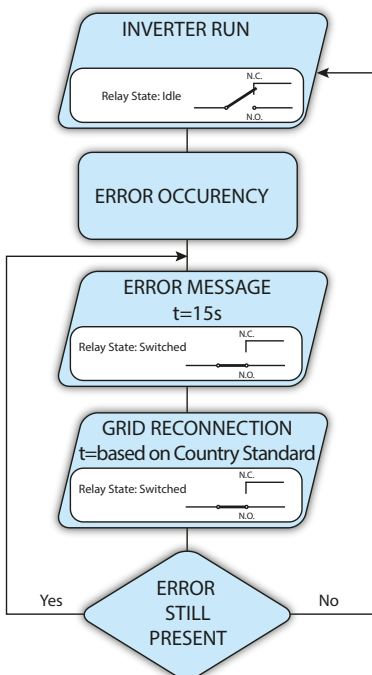

• **Alarm Latch - display text “Alarm-Contact (alarm ALL - latch)”:**

The relay is activated (status: switched) whenever an error (code Exxx) or a warning (code Wxxx) is present (see the table below). When the inverter returns to the normal operating state and reconnects with the grid, the contact returns to its position of rest.

Alarms for which the relay is activated

E001	E002	E003	E004	E005	E006
E007	E010	E011	E012	E013	E014
E015	E016	E017	E018	E019	E020
E021	E022	E023	E025	E026	E027
E028	E029	E030	E031	E032	E033
E034	E035	E036	E037	E046	E050
E051	E053	E054	E055	E056	E057
E058	E065	E066	E067	E068	E069
E070	E074	E077	E078	E080	E084
E086	E087	E088	E089		
W002	W003	W004	W005	W006	W007
W009	W011	W015	W017	W018	W019
W021	W022	W023	W024	W027	W029
W030	W036	W037	W039	W040	W042
W043	W046	W047	W048	W051	W058
W059					

If the alarm condition is persistent, the relay will remain activated (status:switched)

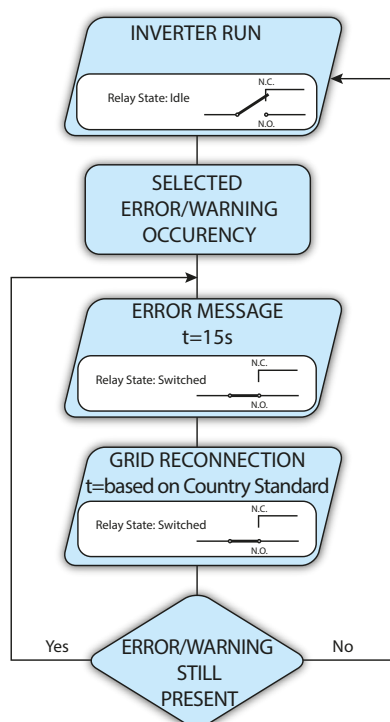
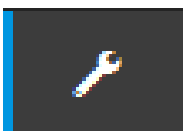

• **Latch configurable alarm - display text “Alarm-Contact (alarm configurable - latch)”:**

The relay is activated (status: switched) whenever an error (code Exxx) or a warning (code Wxxx) is present from those selected from the list in the dedicated submenu **Alarm Config** of the inverter display (see the table below). When the inverter returns to the normal operating state and reconnects with the grid.

Alarms for which the relay is activated

E001	E002	E003	E004	E005	E006
E007	E010	E011	E012	E013	E014
E015	E016	E018	E019	E020	E021
E022	E023	E025	E026	E027	E028
E029	E030	E031	E032	E033	E034
E036	E037	E046	E050	E051	E053
E054	E055	E056	E057	E058	E065
E066	E067	E068	E069	E070	E074
E077	E078	E080	E084	E086	E087
E088	E089				
W002	W003	W004	W005	W006	W007
W009	W011	W015	W017	W018	W019
W021	W022	W023	W024	W025	W027
W029	W030	W031	W037	W039	W040
W042	W043	W046	W047	W048	W051
W058	W059				

If the alarm condition is persistent, the relay will remain activated (status:switched)



• **Ext configurable alarm - display text “Alarm-Contact (alarm configurable - matrix)”:**

In this mode, it is possible to configure the behaviour of the alarm relay according to an external error table which can be setup with the Aurora Manager LITE software. In the table it is possible to select the alarms or warnings for which the alarm relay is activated (status: switched); for each individual alarm it is also possible to select the “Latch” or “No Latch” mode.

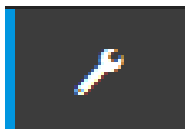

• Load Manager - display text “Load Management”:

Load Manager functionality it allow you to define configurable power thresholds for wich the relay is activated (status: switched) to a specific configurable power thresholds.

Once this mode has been selected, the parameters for which the relay is activated and deactivated have to be set.

The power thresholds “Power Threshold On” and “Power Threshold Off” refers to the inverter output Power (Pout).

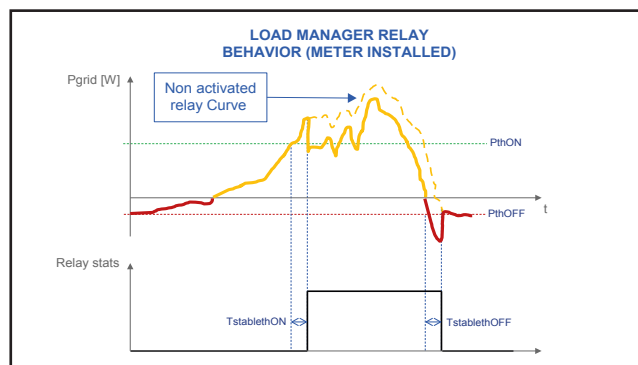
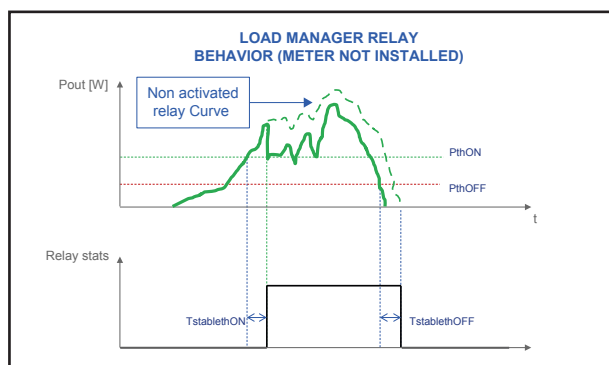

Local I/O Manager Settings

Config

Load Management

Description ⓘ

Please fill the input

Required

Mode

AUTO

Power Threshold On [W]

0

Power Threshold Off [W]

0

TStableThOnM (Minutes)

0

TStableThOffM (Minutes)

0

Back
SAVE

- Mode: It's possible to select AUTO (which is the default values for a load management working), ON (which lock the relay in switched status), OFF (which lock the relay in rest status).

- Power Threshold On [W]: Upper Power threshold (Pgrid/ Pout) for which the relay is activated (status: switched).

- Power Threshold Off [W]: Lower Power threshold (Pgrid/ Pout) for which the relay is deactivated (status: rest position).

- TStableThOnM (Minutes): Minimum time for which the Pgrid/Pout shall remain above the “Power Threshold On” relay activation (status: switched).

- TStableThOffM (Minutes): Minimum time for which the Pgrid/Pout shall remain under the “Power Threshold Off” before the relay deactivation (status: rest position).



Country Standard

By accessing to the **Country Standard** sub-menu you can modify the grid standard within 24 hours while the inverter is operating.



*After the grid standard was set you have 24 hours to make any changes to the grid standard value; 24 hours later the **Country Standard** sub-menu will be locked, and any subsequent changes can only be made accessing with **Adim Plus** privileges. Refer to the dedicated section on this topic in the manual to know how to unlock the **Country Standard** sub-menu.*

Country standard

i You can change the parameter in the first 24 hours if you logged in as admin. After this time, you can reset the 24 hours only if you logged in as admin plus

Grid Standard

CEI 021 - internal protection ▼

RESET SAVE



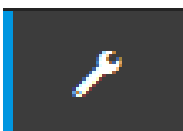

Firmware Update

By accessing to the **Firmware Update** sub-menu you can upgrade the firmware of the inverter and his components selecting a Remote firmware Update or a Local firmware Update.



*Perform the update during good irradiation conditions (avoid the dawn and dusk hours).
An interruption of updating process could damage the inverter!*

• Remote firmware Update:

- In remote mode, the firmware will update automatically, searching the last available firmware on ABB servers, by clicking the “CHECK” button.

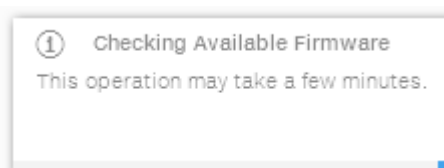

- After the finish of the checking process the available release will be notified on the bottom part of the section
- Click on “UPDATE” button to start with the updating process.

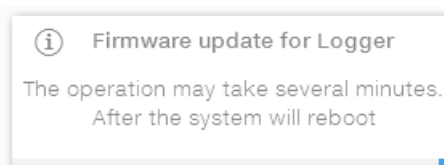

• Local firmware Update:

By updating in local mode, the firmware have to be selected and uploaded from local folder of the used devices to access to the web server.

The latest firmware version is available from the download area of the website www.abb.com/solarinverters. See “Calculation of second-level password (Service menu, Admin Plus)” paragraph.

- Click on “FW SELECT” and select the firmware package previously downloaded.

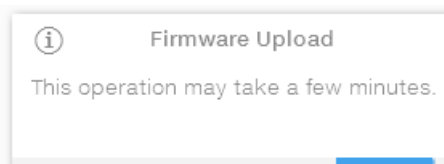

- Click on “UPDATE” button to start with the updating process.

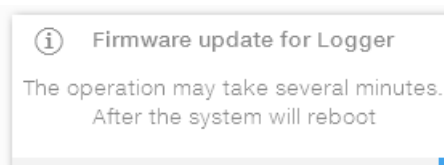



Date and Time

In the **Date and Time** sub-menu it's possible to set the date, time and time zone.

The inverter will propose these fields when the time protocol is available).

When it's not possible for the inverter to detect the time protocol, these fields have to be manually entered.

← Remote FW Update

You can update the inverter connecting to Aurora Vision. The procedure may take several minutes.

Remote Local

Inverter

Current Firmware Release
----- - 0.8.2

Available Release
none - 0.8.3

UPDATE

Date and Time

✓ Network Time Protocol server has been detected and it will be used to keep the system clock synchronized.

Date ✓

Feb 22, 2017

SET by the NTP server

Time ✓

4:52 PM

SET by the NTP server

Time Zone

Europe/Berlin GMT+01:00

SAVE





INFORMATION Section

In the **INFORMATION** Section it's possible to view the general informations about the embedded webserver.

it's possible to access the following sub-menus:

- **Privacy Policy**
- **Provider Information/Impressum**
- **Acknowledgments**
- **Release Notes**





Description of the Display menus

The ABB inverters are equipped with a graphic display ⑦, consisting of 2 lines of 16 characters each, which can be used to:

- Display the operating status of the inverter and the statistical data
- Display service messages for the operator
- Display the alarm and fault messages
- Change the inverter settings.

General information

While the inverter is operating, the display shows various items of information on the main parameters measured, the operating conditions and the inverter's operating status.

When the icon  appears on the display, information is shown cyclically; if the padlock icon  is displayed it means that the display of information is locked and the UP and DOWN buttons can be used to scroll through the screens of information instead.

The sequence of screens displayed is shown below, with a description of the parameters monitored.

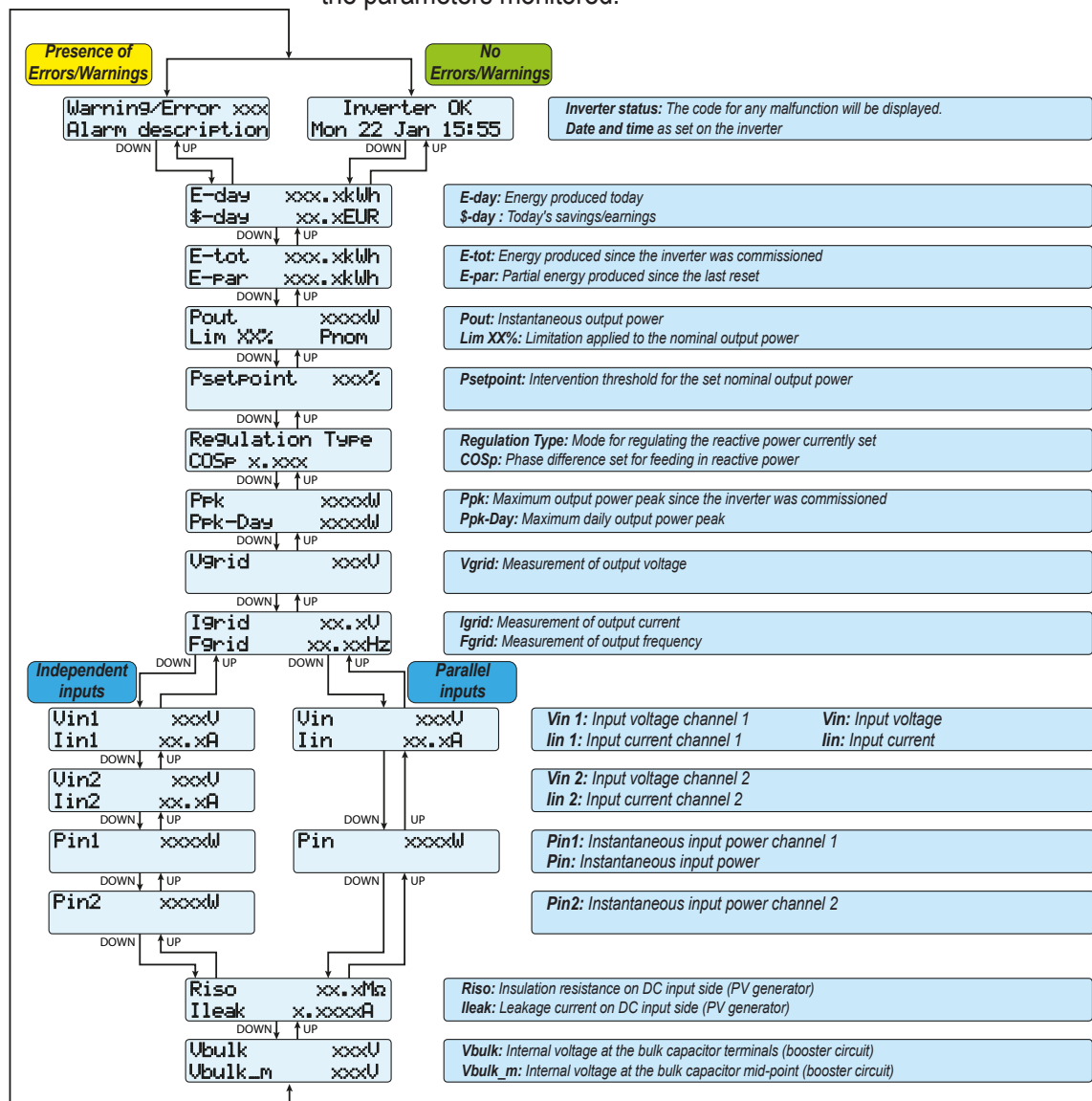

Menu structure

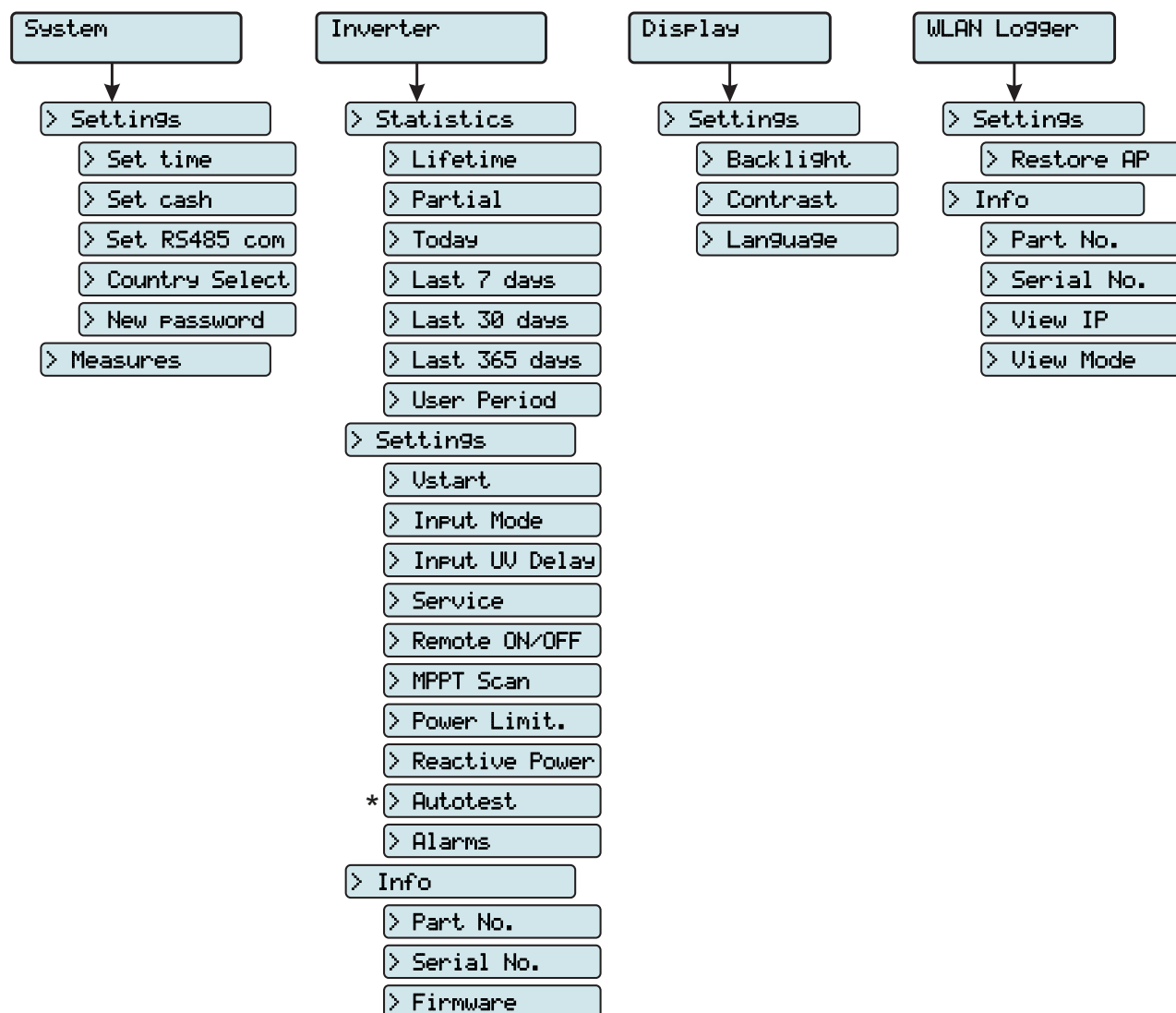

(*): Available for the Italian country standard only.

System Menu

By selecting the **System** menu, the following menus can be accessed:

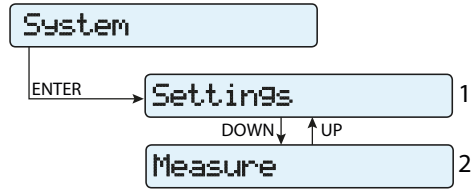

Settings

Selecting **Settings** brings up the first screen relating to the password.

The default password is "0000".

This can be modified by using the display buttons, always following the same procedure:

- ENTER scrolls through the digits (from left to right)
- ESC returns to the previous digit (from right to left)
- Press ESC several times to return to the previous menus
- DOWN scrolls down the numerical scale (from 9 to 0)
- UP scrolls up the numerical scale (from 0 to 9)

After entering the password, press ENTER to access the information in this section:

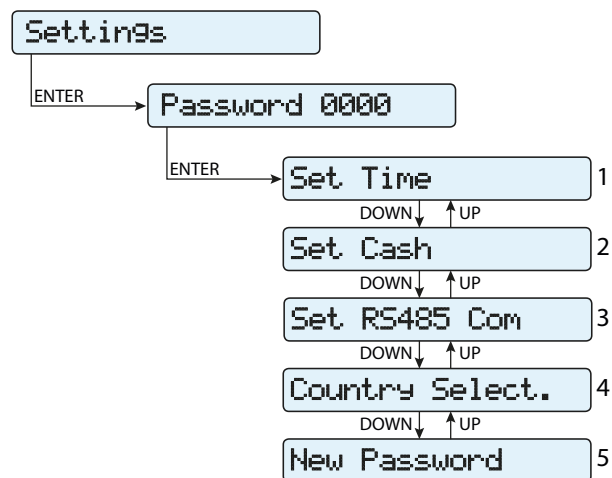

1. Set Time

Allows you to set the current date and time (not counting daylight savings time)

2. Set Cash

This section of the menu allows you to set the name of the currency and the value of 1 kWh of energy produced. Setting these parameters correctly allows the actual earnings/savings achieved by the system to be displayed.

- **Currency:** sets the desired currency
- **Val/KWh:** indicates the cost/incentive for 1 kWh in the chosen currency (default is 0.50).

3. Set RS485 Com

This section of the menu allows you to adjust the settings relating to the RS485 communication serial line:

Set Port 1:

- **Address RS485:** It allows you to set the address for serial communication of the individual inverters connected to the RS485 line. The UP and DOWN buttons scroll through the numerical scale. (The addresses that can be assigned are 2 to 63).
- **Protocol:** It allows you to set the type of protocol to be used for the RS485 line. The proprietary "Aurora-(Slave)", "ModBusRTU-ABB", "ModBusRTU-Sunsp" protocol can be selected depending on the device to which the inverter communicates.
- **Parity:** It allows you to set the Parity bit (None, Even, Odd).
- **Baud Rate:** It allows you to set the Baud Rate (2400/4800/9600/19200/34800/57600/115200).

4. Country Select.

It allows you to modify the grid standard (this option can be selected before the inverter is switched on) within 24 hours while the inverter is operating.

- **Set Std:** allows you to set the required grid standard.
- **Residual Time:** indicates the time remaining until the "Country Select" feature is blocked.
- **Reset Country:** Unlocks the grid standard selection (resets the 24 hours available for changing the grid standard).



After the grid standard was set you have 24 hours to make any changes to the grid standard value; 24 hours later the "Country Select." functionality will be blocked, and any subsequent changes can only be made using a password provided on request by ABB (refer to dedicated chapter in this manual).

5. New Password

This section of the menu allows you to change the settings menu password (default 0000).



*We advise you to memorise the new password.
If the Password is lost you will not have access to the inverter, since there is no Reset function for security reasons.*

Measures

By selecting **Measures** it is possible to display the instantaneous value of the input power (PV Pw) and the instantaneous value of the output power (Pinv).

Inverter Menu

By selecting the **Inverter** menu, the following submenus can be accessed:

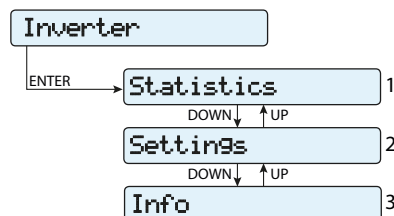

Statistics

By selecting **Statistics**, the following menus can be accessed:

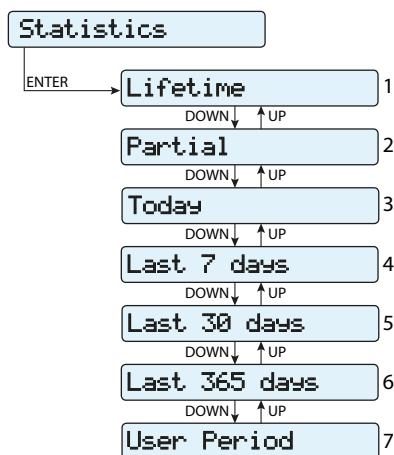

1. Total

This section of the menu displays the Total statistics:

- **Time:** Total operating time
- **E-tot:** Total energy produced
- **P-Peak:** Peak power value
- **Val. :** Total production value, calculated using the currency and conversion coefficient set in the relevant section of the SETTINGS menu
- **CO₂:** Amount of CO₂ saved compared to fossil fuels

2. Partial

This section of the menu displays the Partial statistics:

- **Time:** Partial operating time
- **E-par:** Partial energy produced
- **Val. :** Partial production value, calculated using the currency and conversion coefficient set in the relevant section of the SETTINGS menu
- **CO₂:** Partial amount of CO₂ saved



To reset all the counters of this sub-menu, press the ENTER button for more than 3 seconds. At the end of this time, you will hear a sound repeated 3 times.

3. Today

This section of the menu displays today's statistics:

- **E-day:** Energy produced today
- **P-Peak:** Today's peak power value
- **Val. :** Value of today's production, calculated using the currency and conversion coefficient set in the relevant section of the SETTINGS menu
- **CO₂:** Amount of CO₂ saved today

4. Last 7 days

This section of the menu displays the statistics for the last 7 days:

- **E-7d:** Energy produced over the last 7 days
- **Val. :** Value of production over the last 7 days, calculated using the currency and conversion coefficient set in the relevant section of the SETTINGS menu
- **CO₂:** Amount of CO₂ saved over the last 7 days

5. Last 30 days

This section of the menu displays the statistics for the last 30 days:

- **E-30d:** Energy produced over the last 30 days
- **Val. :** Value of production over the last 30 days, calculated using the currency and conversion coefficient set in the relevant section of the SETTINGS menu
- **CO₂:** Amount of CO₂ saved over the last 30 days

6. Last 365 days

This section of the menu displays the statistics for the last 365 days:

- **E-365d:** Energy produced over the last 365 days
- **Val. :** Value of production over the last 365 days, calculated using the currency and conversion coefficient set in the relevant section of the SETTINGS menu
- **CO₂:** Amount of CO₂ saved over the last 365 days

7. User period

This section of the menu displays the statistics for a period chosen by the user.

Once the start and end dates for the period have been set, the following data are available:

- **E-user:** Energy produced over the selected period
- **Val. :** Value of production over the selected period, calculated using the currency and conversion coefficient set in the relevant section of the SETTINGS menu
- **CO₂:** Amount of CO₂ saved over the selected period



Settings

Selecting **Settings** brings up the first screen relating to the password.
The default password is "0000".

This can be changed by using the display buttons, following the same procedure as always:

- ENTER scrolls through the digits (from left to right)
- ESC returns to the previous digit (from right to left)
- Press ESC several times to return to the previous menus
- DOWN scrolls down the numerical scale (from 9 to 0)
- UP scrolls up the numerical scale (from 0 to 9)

After entering the password, press ENTER to access the information in this section:

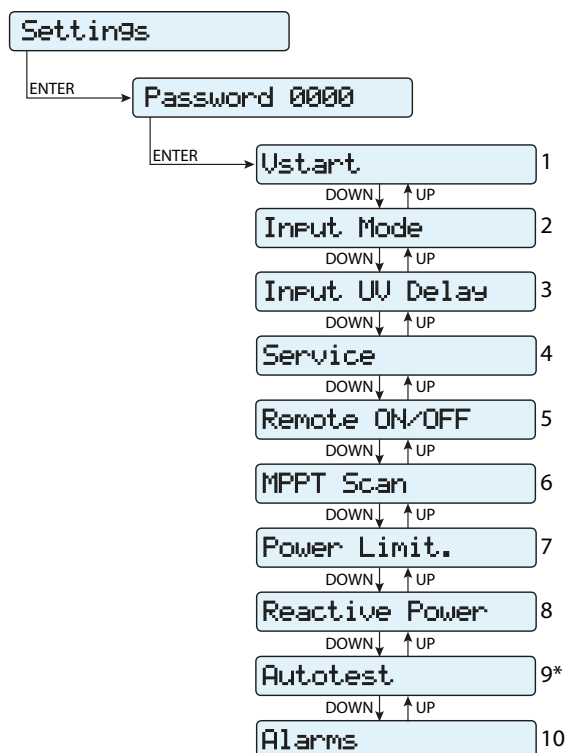

(*) Available for the Italian country standard only. Refer to the section on this topic in the manual.



1. Vstart

This section of the menu is used to set the Vstart activation voltage (for the two channels separately if they are configured independently) to adapt it to the needs of the system. This voltage imposes a minimum input voltage on the inverter above which connection to the grid will be attempted.



We advise changing the activation voltage only if really necessary and to set it to the correct value: the photovoltaic generator sizing tool available on the ABB website will indicate whether Vstart needs changing and what value to set it to.

2. Input Mode

This section of the menu allows you to set the input configuration mode. In particular:

- **Independent:** Independent configuration of the two input channels. This configuration is set by default.
- **Parallel:** Parallel configuration of the input channels (single input channel). Other hardware settings must be set on the inverter to set this mode. Refer to the paragraph "Parallel channel configuration".

3. Input UV Delay

This section of the menu allows you to set the time for which the inverter stays connected to the grid after the input voltage has dropped below the Under Voltage limit (set at 70% of Vstart).

This value can be set from 1 to 3600 seconds (60 seconds is the default setting).

Example: With Input UV Delay set at 60 seconds, if voltage V_{in} drops below 70% of Vstart at 9.00, the inverter stays connected to the grid (taking power from it) until 9.01.



4. Service

This section of the menu is reserved for installers.

A special access password is required, which may be obtained by contacting ABB Technical Sales (1-877-261-1374).

Before connecting to the site, make sure you have all the information required to calculate your password: Inverter Model, Serial Number and week of manufacture of the Inverter

When you have a password you can set the parameters in the menu.

Changing the above-mentioned parameters may prevent disconnection from the grid if the new values exceed those given in the standards of the country of installation. If these parameters are changed to values outside the standard range, an interface protection must be installed external to the inverter in accordance with the requirements of the country of installation.

The table below shows the parameters which cannot be modified.

Parameter	Description
Set U>>	Grid over-voltage (OV) threshold (extended range)
Set U>	Grid over-voltage (OV) threshold (restricted range)
Set U> (10Min)	Grid over-voltage (OV) threshold (average grid voltage value)
Set U<	Grid under-voltage (UV) threshold (restricted range)
Set U<<	Grid under-voltage (UV) threshold (extended range)
Set F>>	Grid over-frequency (OF) threshold (extended range)
Set F>	Grid over-frequency (OF) threshold (restricted range)
Set F<	Grid under-frequency (UF) threshold (restricted range)
Set F<<	Grid under-frequency (UF) threshold (extended range)
Set Connect	
> Set U>Connect	Max. permissible voltage during checks prior to grid connection
> Set U<Connect	Min. permissible voltage during checks prior to grid connection
> Set F>Connect	Max. permissible frequency during checks prior to grid connection
> Set F<Connect	Min. permissible frequency during checks prior to grid connection
> Set Time con.	Grid check time prior to connection
> Set T GridFault	Grid check time prior to connection after a grid fault
Set Slow Ramp	Enables gradual ramping up of power after the grid connection.
Set OF Derating	
> OF Der. Mode	Selects the power derating mode in the event of grid over-frequency.
> OF Der. Res. T.	Time period after OF derating in which the inverter checks that the frequency is back within the operating ranges (parameters "F<Connect" "F>Connect") required by the grid standard before ramping up the output from the derating condition.
Reset Latch	Allows the Latch alarms present to be reset manually



5. Remote ON/OFF

This section of the menu is used to enable/disable connection/disconnection of the inverter from the grid using the special control signal (**R+**) for inverter equipped with UNO-DM-COM KIT or UNO-DM-PLUS-COM ETHERNET KIT.

- **Disabled:** the connection/disconnection of the inverter to/from the grid is dictated by the input (voltage from the photovoltaic generator) and output (grid voltage) parameters of the inverter.
- **Enable:** connection/disconnection of the inverter from the grid is dictated (as well as by the inverter input - voltage from the photovoltaic generator - and output parameters - grid voltage) by the state of the signal **R+** with respect to the signal **RTN**.

6. MPPT Scan

This section of the menu allows you to set the parameters of the maximum power point tracking (MPPT) function. This function is useful when there are areas of shade on the PV generator, which may create several points of maximum power on the operating curve.

- **E/D MPPT Scan:** Enables/disables the scan for identifying the maximum power point of the system.
- **Scan Interval:** This section allows you to set the time between scans. Remember that the shorter the scan interval the greater the loss of production, due to the fact that energy is transferred to the grid during the scan but not at the maximum power point. Each scan takes roughly 2 seconds.

7. Power Limit.

This section of the menu allows you to adjust the limit to the active power that the inverter can feed into the grid by setting the percentage of nominal power at which the limit should be triggered.

Setting it to 100% resets the default maximum power, which in some installation country standards may be 110% of nominal power



8. Reactive Power

This section of the menu may be used to manage the supply of reactive power into the grid. There are 5 possible types of management:

- **Q: No Regulation:** no regulation of reactive power. To activate this mode, press **ENTER** and then press **ENTER** to confirm.
- **Cos-phi fixed:** Sets the power rating to a fixed value. To activate this mode, press **ENTER** and set the Cos-Phi value to Over excited or Under excited, from 1.000 to 0.8000; press **ENTER** to confirm.
- **Q Fixed:** Sets the reactive power to a fixed value. To enable this mode, select **Enable** and then **OK** (using the UP / DOWN arrows). When enabled, **Set value** will appear on the display, allowing you to set the value of the reactive power (as either Over or Under excited, from 1.000 to 0.001)
- **Cos-phi = f(P):** Power rating as a function of the active power supplied by the inverter. To enable this mode, select **Enable** and then **OK** (using the UP / DOWN arrows). When it has been enabled, **Load std curve** will appear on the display, allowing you to set the following control curve:

The curve can be modified using the Aurora Manager Lite configuration software

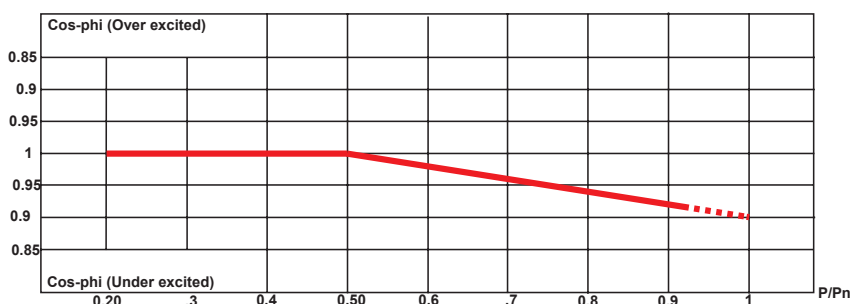

- **Q = f(U):** reactive power as a function of the grid voltage measured by the inverter. To enable this mode, select **Enable** and then **OK** (using the UP / DOWN arrows). When it has been enabled, **Load std curve** will appear on the display, allowing you to set the following control curve:

The curve can be modified using the Aurora Manager Lite configuration software

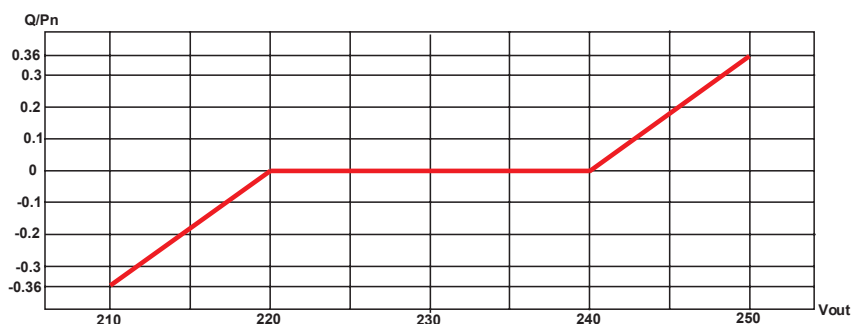

9. Alarm

This features will work only on inverter equipped with UNO-DM-COM KIT or UNO-DM-PLUS-COM ETHERNET KIT.

This section of the menu allows you to set the activation status of a relay (available either as contact normally open – N.O. - and as a normally closed contact -N.C.) and to configure customised alarm conditions.

This contact can be used, for example, to: activate a siren or a visual alarm, control the disconnect device of an external transformer, or control an external device.

Relay switching can be set in 9 different modes using the submenu **Set Alarm Type** (For the "Alarm Conf.", "Al. Conf. Latch", "Al. Conf. Ext.", "GoGo Rel(Auto)" and "GoGo Rel(Remote)" it is possible to configure customised alarm conditions through the submenu **Alarm Config**:

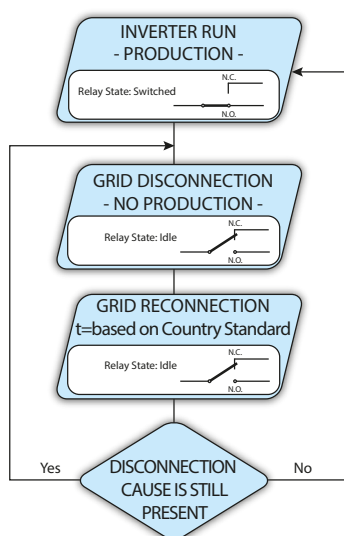

• Production (display text “Production”)

The relay is activated (status: switched) whenever the inverter connects to the grid; as soon as the inverter is disconnected from the grid (for whatever reason that caused disconnection), the relay is in its resting position.

• Alarm with reset at the end of the alarm signalling process (display text “Alarm”):

The relay is activated (status: switched) whenever an error (code Exxx) or warnings related to grid parameters out of range (Warning – codes W003, W004, W005, W006, W007) are present on the inverter. The alarm returns to its resting position when the alarm signal ends, i.e. before the inverter checks the grid parameters after the alarm state. This is because grid control state is not an alarm state but a state of normal operation.

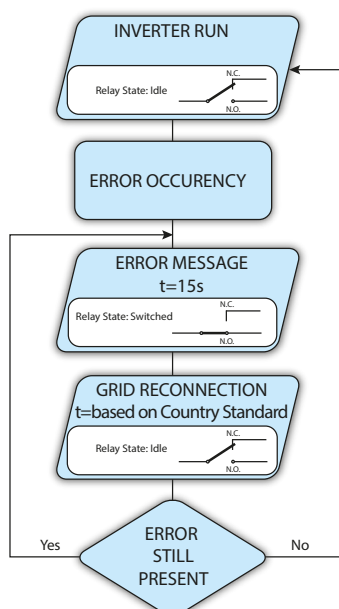

Alarms for which the relay is activated

E001	E002	E003	E004	E005	E006
E007	E010	E011	E012	E013	E014
E015	E016	E017	E018	E019	E020
E021	E022	E023	E025	E026	E027
E028	E029	E030	E031	E032	E033
E034	E035	E036	E037	E046	E050
E051	E053	E054	E055	E056	E057
E058	E065	E066	E067	E068	E069
E070	E074	E077	E078	E080	E084
E086	E087	E088	E089		
W002	W003	W004	W005	W006	W007
W009	W011	W015	W017	W018	W019
W021	W022	W023	W024	W027	W029
W030	W036	W037	W039	W040	W042
W043	W046	W047	W048	W051	W058
W059					

In the presence of W003, W004, W005, W006, W007 signalling, the alarm contact switches to then reset itself at the end of the alarm signal. This means that during the absence of grid voltage (display message "Missing Grid") the alarm contact remains in its resting position.

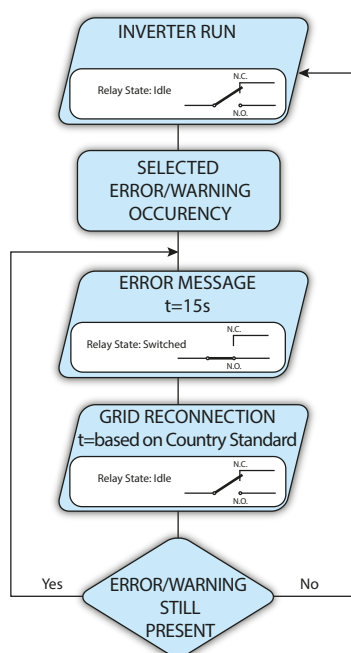

• **Configurable alarm with reset at the end of the alarm signalling process (display text “Alarm Conf.”)**

The relay is activated (status: switched) whenever an error (code Exxx) or a warning (code Wxxx) is present from those selected from the list in the dedicated submenu **Alarm Config**. The contact returns to its resting position when the alarm signal ends, i.e. before the inverter checks the grid after the alarm state. This is because grid control state is not an alarm state but a state of normal operation.

Alarms for which the relay is activated

E001	E002	E003	E004	E005	E006
E007	E010	E011	E012	E013	E014
E015	E016	E018	E019	E020	E021
E022	E023	E025	E026	E027	E028
E029	E030	E031	E032	E033	E034
E036	E037	E046	E050	E051	E053
E054	E055	E056	E057	E058	E065
E066	E067	E068	E069	E070	E074
E077	E078	E080	E084	E086	E087
E088	E089				
W002	W003	W004	W005	W006	W007
W009	W011	W015	W017	W018	W019
W021	W022	W023	W024	W025	W027
W029	W030	W031	W037	W039	W040
W042	W043	W046	W047	W048	W051
W058	W059				

For the configurable relay operating mode “Alarm Conf.”, the following considerations are valid:

If the alarm condition is persistent, the alarm contact cyclically switches from its resting state to its activated state.

In the presence of W002 signalling (Input UV – input voltage below the limit of operation), the alarm contact switches to then reset itself at the end of the alarm signal. This means that during the reduced input voltage (display message “Waiting Sun”) the alarm contact remains in its resting position.

In the presence of W003, W004, W005, W006, W007 signalling, the alarm contact switches to then reset itself at the end of the alarm signal. This means that during the absence of grid voltage (display message “Missing Grid”) the alarm contact remains in its resting position.



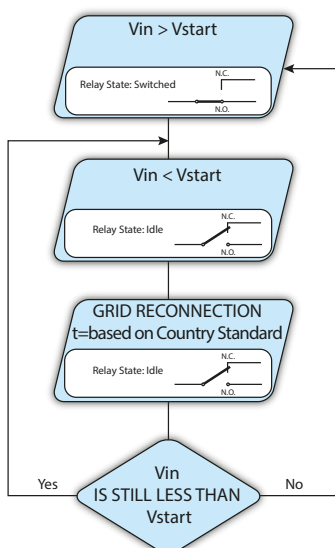

• **Crepuscular (display text “Crepuscular”)**

The relay is activated (status: switched) as soon as the inverter input voltage exceeds the activation voltage set.

The relay switch to rest position when the input voltage drops below 70% of the activation voltage set.

This mode is useful for disconnecting any output transformers that could have unnecessary consumption during the night.

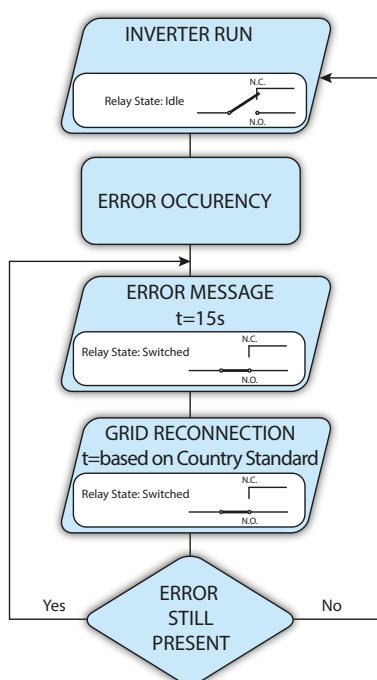

• **Alarm Latch (display text “Alarm Latch”)**

The relay is activated (status: switched) whenever an error (code Exxx) or a warning (code Wxxx) is present (see the table below). When the inverter returns to the normal operating state and reconnects with the grid, the contact returns to its position of rest.

Alarms for which the relay is activated

E001	E002	E003	E004	E005	E006
E007	E010	E011	E012	E013	E014
E015	E016	E017	E018	E019	E020
E021	E022	E023	E025	E026	E027
E028	E029	E030	E031	E032	E033
E034	E035	E036	E037	E046	E050
E051	E053	E054	E055	E056	E057
E058	E065	E066	E067	E068	E069
E070	E074	E077	E078	E080	E084
E086	E087	E088	E089		
W002	W003	W004	W005	W006	W007
W009	W011	W015	W017	W018	W019
W021	W022	W023	W024	W027	W029
W030	W036	W037	W039	W040	W042
W043	W046	W047	W048	W051	W058
W059					

If the alarm condition is persistent, the relay will remain activated (status:switched)

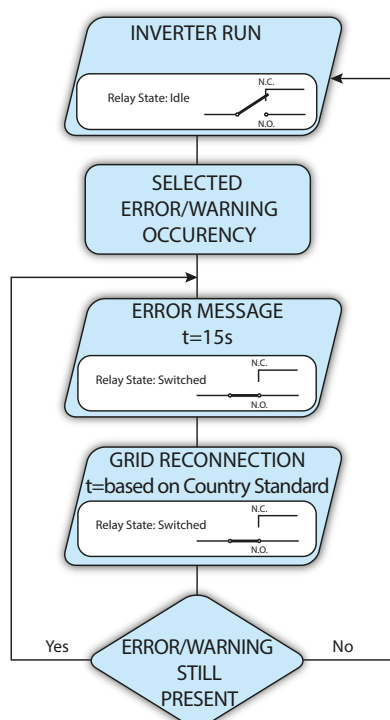

• Latch configurable alarm (display text “Al. Conf. Latch”)

The relay is activated (status: switched) whenever an error (code Exxx) or a warning (code Wxxx) is present from those selected from the list in the dedicated submenu **Alarm Config** (see the table below). When the inverter returns to the normal operating state and reconnects with the grid.

Alarms for which the relay is activated

E001	E002	E003	E004	E005	E006
E007	E010	E011	E012	E013	E014
E015	E016	E018	E019	E020	E021
E022	E023	E025	E026	E027	E028
E029	E030	E031	E032	E033	E034
E036	E037	E046	E050	E051	E053
E054	E055	E056	E057	E058	E065
E066	E067	E068	E069	E070	E074
E077	E078	E080	E084	E086	E087
E088	E089				
W002	W003	W004	W005	W006	W007
W009	W011	W015	W017	W018	W019
W021	W022	W023	W024	W025	W027
W029	W030	W031	W037	W039	W040
W042	W043	W046	W047	W048	W051
W058	W059				

If the alarm condition is persistent, the relay will remain activated (status:switched)



• Ext configurable alarm (display text “Al. Conf. Ext.”)

In this mode, it is possible to configure the behaviour of the alarm relay according to an external error table which can be setup with the Aurora Manager LITE software. In the table it is possible to select the alarms or warnings for which the alarm relay is activated (status: switched); for each individual alarm it is also possible to select the "Latch" or "No Latch" mode.

• Load Management (display text “Gogo rel. remote”)

It allows you to enable the Load Management functionality with which the relay is activated (status: switched) to a specific configurable power input threshold. Once this mode has been selected, the parameters for which the relay is activated have to be set (status: switched) on the dedicated section of internal webserver (see specific chapter).

Info

By selecting the **Info** menu, the following menus can be accessed:

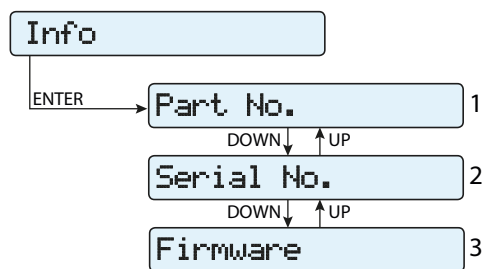

1. Part No.

Displays the model code

2. Serial number

Displays the serial number and week and year of manufacture of the equipment

3. Firmware

Lets you view the revision of the firmware installed on the equipment.



Display Menu

By selecting the **Display** menu, the following submenus can be accessed:

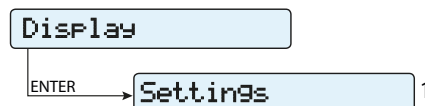

Settings

Selecting **Settings** brings up the first screen relating to the password. **The default password is "0000"**.

This can be changed by using the display buttons, following the same procedure as always:

- ENTER scrolls through the digits (from left to right)
- ESC returns to the previous digit (from right to left)
- Press ESC several times to return to the previous menus
- DOWN scrolls down the numerical scale (from 9 to 0)
- UP scrolls up the numerical scale (from 0 to 9)

After entering the password, press ENTER to access the information in this section:

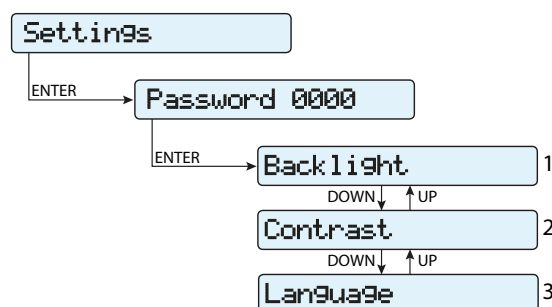

1. Backlight

This section of the menu allows you to set the backlighting display characteristics:

Mode:

ON: Light always on

OFF: Light always off

AUTO: Automatic backlight control. It activates each time a button is pressed and remains active for 30 seconds, after which time it gradually dims and deactivates.

2. Contrast

This section of the menu allows you to set the contrast of the display (on a scale of 1 to 9).

3. Language

Allows you to set the language you prefer for the menus

WLAN Logger Menu

By selecting the **WLAN Logger** menu, the following submenus can be accessed:

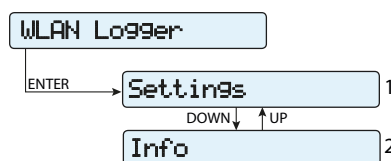

Settings

Selecting **Settings** brings up the first screen relating to the password. **The default password is "0000".**

This can be changed by using the display buttons, following the same procedure as always:

- ENTER scrolls through the digits (from left to right)
- ESC returns to the previous digit (from right to left)
- Press ESC several times to return to the previous menus
- DOWN scrolls down the numerical scale (from 9 to 0)
- UP scrolls up the numerical scale (from 0 to 9)

After entering the password, press ENTER to access the information in this section:

1. Restore AP

This section of the menu allows you to restore the "Access Point" mode of the wireless module of the inverter.

Info

By selecting the **Info** menu, the following menus can be accessed:

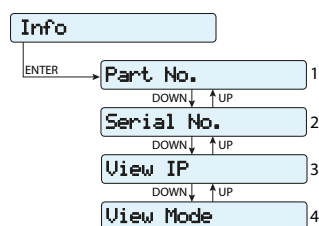

1. Part No.

Allows you to view the part number of the wireless board.

2. Serial number

Allows you to view the serial number, the week and year of manufacture of the wireless board.

3. View IP.

Allows you to view the IP address assigned to the wireless board.

4. View Mode

Allows you to view the operating mode of the wireless board ("Access Point" or "Host").

Maintenance

8

Introduction and maintenance warnings

Routine preventive maintenance is required to maintain warranty coverage. Maintenance must be entrusted to only those individuals with knowledge of how to perform these tasks and a thorough understanding of the PV plant.



Turn off the inverter.

Open and lock out/tag out all external AC and DC disconnects before starting preventive maintenance.



For cleaning, DO NOT use rags made of filamentary material or use corrosive products that may corrode the equipment.

DO NOT allow the equipment to be used if problems of any kind are found.

Always use personal protective equipment (PPE) provided by the employer and comply with local safety regulations.

Routine maintenance

Routine maintenance operations should not be considered obligatory, but rather as recommended in order to maintain the efficiency of the PV system.



It is recommended that maintenance operations are only performed by qualified personnel. The maintenance schedule may vary depending on the environmental conditions of the installation premises.

Table: routine maintenance

Annual visual inspections

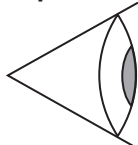

- Check that the inverter is operating properly, without any alarm signals
- Ensure that all the safety labels and symbols are visible
- Check the integrity of the cables, connectors and cable glands outside the inverter
- Check that the environmental conditions have not changed dramatically from those on installation

Annual operations



- Check the tightening of the cable glands and of the screw terminal blocks
- Check the front cover is fixed
- If there is no monitoring system, check the record of alarms and errors using the indications given in the manual in order to check recent malfunction signals

Annual cleaning



- Clean the equipment; in particular the heat sink (using compressed air)



Troubleshooting



Operations on the inverter to identify and address any faults may only be performed by the installer or by qualified personnel.

Internal Webserver and wireless communication troubleshooting

The following table gives a list of main and most common errors or problems relating to the wireless communication between inverter and user devices.

Problem	Possible causes	Solution
The internal webserver cannot be accessed.	ADMIN or USER password forgotten.	Reset the passwords by clicking on "Forgot your password"; The passwords can be reset after having entered the "Product Key" code that can be found on the "Wireless Identification Label".
The inverter is able to identify a wireless network but is unable to connect to it.	The signal between the inverter and the wireless router to which the board wants to connect is too weak.	Modify the position of the wireless antenna, the inverter or the router.
		Make sure that the inverter has not been installed near obstacles which could affect the communication with the wireless router (for example: metal cages or walls, walls in reinforced concrete, electromagnetic fields).
		Move the router as close as possible to the inverter.
The Inverter has not identified the wireless network to which connection is required.	The wireless network to which the inverter is to be connected, could require the user to enter a username and password to allow navigation (for example, with a public wireless network or a hotel).	Unfortunately the inverter cannot be connected to these types of wireless networks. Connect the inverter to an alternative wireless network.
	The wireless network to which the Inverter is to be connected, is set so as not to be identified (hidden network).	The Inverter is not able to connect to a hidden network. Set the wireless network to which the inverter is to be connected (visible network), then identify and connect the Inverter to the wireless network as normal.
The Inverter has not identified the wireless network to which connection is required.	The signal between the inverter and the wireless router to which the board wants to connect is too weak.	Modify the position of the wireless antenna, the inverter or the router.
		Make sure that the inverter has not been installed near obstacles which could affect the communication with the wireless router (for example: metal cages or walls, walls in reinforced concrete, electromagnetic fields).
		Move the router as close as possible to the inverter.
The wireless board does not communicate correctly with the inverter inside of which it is installed (inconsistency in the detected data read by the board), or when working in "Access Point Mode", it's not possible to access the internal webserver.	The wireless board of the inverter could be damaged.	Request a service intervention to check that the inverter wireless board is working correctly.
	Wrong Inverter Date/Time settings.	Check if Date/Time has correctly set on the inverter; correct it if necessary.
Alternating difficulties in the local connection to the internal webserver.	The inverter might not be correctly powered (for example, if the inverter is switched off at night, the internal webserver cannot be accessed).	Access to the internal webserver only when the inverter is correctly powered.
	The wireless connection signal between the device in use and the router or the Inverter, may not have sufficient power or it may be disturbed by obstacles which affect the communication.	Make sure that the signal between the wireless devices which interact with the inverter are sufficiently high and that any obstacles such as metal cages or walls, walls in reinforced concrete or strong electromagnetic fields do not affect communication.



Problem	Possible causes	Solution
Although the Inverter has been configured correctly in "Station Mode" and works correctly on the local network, no data has been transmitted to the Aurora Vision®.	The MAC address used to register the inverter on the Aurora Vision® platform is not the same as the actual address associated with the inverter.	Make sure that the MAC address registered on the Aurora Vision® platform is actually the one associated with the inverter. If it is not, modify the registered MAC address.
	The wireless network to which the Inverter is connected, could be protected by a Firewall which prevents the remote exchange of data with the Aurora Vision® platform.	Contact the network administrator in order to have the Firewall configured so that the remote exchange of data between the Inverter and the Aurora Vision® platform is allowed.
During the wizard commissioning phase, after the inverter was configured to operate in "Station Mode" (Commissioning STEP2), the inverter is no longer connected with your device in "AP Mode" and the IP address and the "Host Name" used to continue the wizard commissioning are unknown.	The browser was accidentally closed during the wizard commissioning phase.	Access the Internal Webserver using the "Host Name" that could be obtained writing this url http://ABB-XX-XX-XX-XX-XX-XX.local replacing the "X" with the hex digits of the wireless MAC address of the inverter (it can be found on the "Wireless Identification Label" placed on the side of the inverter or applied during the commissioning phase to the quick installation guide on cover page). The DNS or multicast service must be enabled on router.
		If possible, access the pages of the wireless router webserver to which the inverter is connected and read the IP address assigned to the inverter in the list of connected devices. Follow the " Commissioning (Using the inverter display) " chapter in this manual to complete the inverter commissioning; then access the inverter display menu WLAN Logger>Info>View IP to obtain the IP Address assigned by the router to the inverter. Open an internet browser and enter the obtained IP Address to resume the wizard commissioning (The procedure will be resumed at "STEP 3" phase).
It is not possible to access the Internal webserver when the inverter is operating in "Station Mode – DHCP".	An incorrect dynamic IP address is being used to access the Internal Webserver or the IP address could have been modified by the wireless router to which the inverter is connected.	Access the Internal Webserver using the "Host Name" that could be obtained writing this url http://ABB-XX-XX-XX-XX-XX-XX.local replacing the "X" with the hex digits of the wireless MAC address of the inverter (it can be found on the "Wireless Identification Label" placed on the side of the inverter or applied during the commissioning phase to the quick installation guide on cover page). The DNS or multicast service must be enabled on router. Access the inverter display menu WLAN Logger>Info>View IP to obtain the IP Address assigned by the router to the inverter.
	The links used to access the Internal Webserver was lost.	If possible, access the pages of the wireless router web server to which the inverter is connected and read the new dynamic IP address assigned to the Inverter. Switch off the wireless router to which the inverter is connected so as to force the inverter to operate in "AP mode", then access the internal Webserver via the default IP address 192.168.117.1 . Once inside, select the "Access Point mode only" in the network configuration, then switch on the wireless router to which the inverter is connected. Now it is possible to configure the inverter in "Station Mode - DHCP" again, taking note of the newly assigned dynamic IP address.
	The wireless router doesn't allow the connection to local IP address. Typically this happen on company networks.	Contact the network administrator to allow the wireless router to connect to local IP address.
	The device doesn't allow the connection to local IP address. Typically this happen with company devices.	Contact the system administrator to allow the device to connect to local IP address.
Using an Android devices, a notification advise that internet connection is missing when trying to connect to the Access Point wireless network created by the inverter and ask for connection confirmation.	Known behavior of Android devices. Android OS always check if internet connection are available and ask for confirmation if it's not present.	Confirm the connection request in the notification of Android devices by clicking "Yes".
It is not possible to view the Pdf Auto-test report using an Ios devices.	Popup opening is not allowed on Ios browser.	Allow the popup opening in the browser settings of the Ios devices (A notification will advise you for enable popup when trying to view the pdf autotes report).
During the "Station Mode" network configuration, although the internal webserver pages notify a correct working of wireless communication, the devices are unable to communicate with the inverter.	The device has not been yet connected to the same wireless network to which the inverter is connected.	Connect the device to the same wireless network to which the inverter is connected.









Inverter alarm codes







In order to understand and resolve warning (Wxxx) or error (Exxx) signals that appear in the Alarm section of the internal webserver or on the inverter's display, follow the table given in the following paragraph.











The equipment can notify errors/warnings in the Alarm section of the internal webserver or on the display only if the input voltage is greater than the Vdcm in voltage (POWER Led flashing or lit; see chapter on operation). The messages and related codes are shown in the Alarm section of the internal webserver or on the display.

The following table gives the complete list of errors/warnings relating to string inverters. Some error/warning codes may not be used depending on the inverter model installed.

- Code on display - Error message - Signal	Name of Alarm and Cause	Solution
- R-Iso Low - Ground Fault -  GFI LED	Ground fault of photovoltaic generator: The alarm is generated when a leakage current to ground is detected in the DC section of the system.	<ul style="list-style-type: none"> • Measure the insulation resistance using a megohmmeter positioned in the photovoltaic field (positive terminal short-circuited at the negative pole) respect to ground. The measurement is strongly influenced by the environmental conditions, so must be made under the same conditions in which the error occurred. - If the value measured is lower than 1 megaohm, a check must be carried out by a technician/installer on the photovoltaic generator to identify and eliminate the problem. - If the value measured is higher than 1 megaohm and the error signal persists, contact customer assistance.
- No code - SET COUNTRY or NO NATION -  No LED	SET COUNTRY or NO NATION: Indicates that in the installation phase the grid standard was not set on the inverter.	<ul style="list-style-type: none"> • Set the grid standard of the country of installation following the instructions given in this manual for the inverter. - If the signal persists also after the grid standard has been set, contact customer assistance.
- No code - Missing Grid -  Alarm LED	Missing Grid: The inverter displays the "Missing Grid" message when it does not record output voltage (AC side).	<ul style="list-style-type: none"> • Check the grid voltage on the inverter's AC terminal block. - Should it be absent, check any protection work on the line and the presence of grid voltage on the supply point.
- No code - Memory Fail -  Alarm LED lamp.	Memory fail: The inverter displays the "Memory Fail" message when it records a communication problem with the memory board on which the inverter saves the daily value of energy produced.	<ul style="list-style-type: none"> • Remove the memory board and check the welding of all the connector's terminals. Subsequently reinsert the memory board and check that it is correctly inserted into the dedicated slot - If the signal persists also following the above checks, contact customer assistance.
- No code - Waiting Sun -  Power LED lamp.	Waiting Sun: The inverter displays the "Waiting Sun" message when, following a W001 and/or W002 notice, the voltage from the photovoltaic generator is less than the activation voltage (Vstart).	<ul style="list-style-type: none"> • Check the input voltage on the inverter. - If it does not exceed Vstart, check for the presence of sufficient irradiation and the correct composition of the system. - If it exceeds Vstart, contact customer assistance
- W001 - Sun Low -  Alarm LED	Insufficient irradiation (Low input voltage on switching on the inverter): Incorrect configuration of the PV generator or an "on the limit" configuration for the inverter's minimum input voltage.	<ul style="list-style-type: none"> • Check the input voltage on the inverter. - If it does not exceed Vstart, check for the presence of sufficient irradiation and the correct composition of the system. - If it exceeds Vstart, contact customer assistance
- W002 - Input UV -  Alarm LED	Insufficient irradiation (Low input voltage on switching off): Incorrect configuration of the photovoltaic generator or an "on the limit" configuration for the inverter's minimum input voltage	<ul style="list-style-type: none"> • Check the input voltage on the inverter. - If it does not exceed Vstart, check for the presence of sufficient irradiation and the correct composition of the system. - If it exceeds Vstart, contact customer assistance



- Code on display - Error message - Signal	Name of Alarm and Cause	Solution
- W003 - Grid Fail -  Alarm LED	Parameters of grid voltage outside range: This error signal occurs when during the inverter's normal operation the grid parameters exceed the limits imposed by the grid standard set on the inverter and by the grid operator or the utility: - Grid voltage absent (after the signal the inverter goes to "Missing Grid") - Unstable grid voltage (down or up) - Unstable grid frequency	<ul style="list-style-type: none"> • Check the grid voltage on the inverter. - Should it be absent, check for absence of grid voltage on the supply point. - If, on the other hand, the voltage tends to rise (when the inverter is connected) there is high line or grid impedance. • Check the grid voltage also on the supply. - If it is high, it means that there is high grid impedance. In this case, ask the operator to adjust the grid voltage. If the operator authorises a change to the inverter's parameters, you can set the new limits into the "Inverter>Settings>Service" display menu or into "Setup>Setup AC side" of the internal webserver (refer to dedicated sections of this manual for further information). - If the voltage at the point of supply is much lower than that measured on the inverter, it is necessary to adjust the line (inverter-contactor). - If the voltage and the grid frequency come back within the limits (also when the inverter is connected to the grid) contact customer assistance
- W004 - Grid OV -  Alarm LED	Grid overvoltage: This error signal occurs when during the inverter's normal operation the grid voltage exceeds the maximum limit set by the operator.	<ul style="list-style-type: none"> • Check the grid voltage on the inverter. If the voltage tends to rise (when the inverter is connected), there is a problem of high line or grid impedance. • Check the grid voltage also on the supply. - If it is high, it means that there is high grid impedance. In this case, ask the operator to adjust the grid voltage. If the operator authorises a change to the inverter's parameters, you can set the new limits into the "Inverter>Settings>Service" display menu or into "Setup>Setup AC side" of the internal webserver (refer to dedicated sections of this manual for further information). - If the voltage at the point of supply is much lower than that measured on the inverter, it is necessary to adjust the line (inverter-contactor). - If the voltage and the grid frequency come back within the limits (also when the inverter is connected to the grid), contact customer assistance
 - W005 - Grid UV -  Alarm LED	Grid undervoltage: This error signal occurs when during the inverter's normal operation the grid voltage exceeds the minimum limit set by the operator.	<ul style="list-style-type: none"> • Check the grid voltage on the inverter. • Check the grid voltage also on the supply: - If it is high, it means that there is high grid impedance. In this case, ask the operator to adjust the grid voltage. If the operator authorises a change to the inverter's parameters, agree the new limits with customer assistance - If the voltage at the point of supply is much lower than that measured on the inverter, it is necessary to adjust the line (inverter-contactor). - If the voltage and the grid frequency come back within the limits (also when the inverter is connected to the grid), contact customer assistance
- W006 - Grid OF -  Alarm LED	Grid over-frequency: This error signal occurs when during the inverter's normal operation the grid frequency exceeds the maximum limit set by the operator.	<ul style="list-style-type: none"> • Check the grid frequency in the inverter. • Check the grid frequency also on the supply: - - If the voltage and the grid frequency come back within the limits (also when the inverter is connected to the grid), contact customer assistance
- W007 - Grid UF -  Alarm LED	Grid under-frequency: This error signal occurs when during the inverter's normal operation the grid frequency exceeds the minimum limit set by the operator.	<ul style="list-style-type: none"> • Check the grid frequency in the inverter. • Check the grid frequency also on the supply: - - If the voltage and the grid frequency come back within the limits (also when the inverter is connected to the grid), contact customer assistance
- W010 * - Fan Fail -  Alarm LED lamp. *not visualised on display	Fan Fail: This error occurs when there is a malfunction in the fan/fans inside the inverter.	<ul style="list-style-type: none"> • Error inside the inverter and cannot be checked externally. - If the alarm repeats persistently, contact customer assistance.

- Code on display - Error message - Signal	Name of Alarm and Cause	Solution
- W011 - Bulk UV -  Alarm LED	Low "Bulk" voltage (DC-DC circuit): The alarm (which is a warning and not an error) is generated when the voltage at the heads of the bulk capacitors does not reach the threshold for the operation of the inverter (internal unchangeable threshold).	<ul style="list-style-type: none"> • Raise the value of the activation voltage (Vstart) if the problem at the time of the inverter's grid connection (Using the formulas $0,7 \cdot V_{mp, stc}$ or $0,6 \cdot V_{oc, stc}$). • If the problem occurs in the morning, try to raise the value of the activation voltage (Vstart) (Using the formulas $0,7 \cdot V_{mp, stc}$ or $0,6 \cdot V_{oc, stc}$). • Check the input voltage on the inverter. - If it does not exceed Vstart, check for the presence of sufficient irradiation and the correct composition of the system. - If it exceeds Vstart, contact customer assistance
- W012 * - Batt. Low -  Alarm LED *not visualised on display	Battery Low: The inverter displays the "Battery Low" message when it records a voltage for the buffer battery which is too low.	<ul style="list-style-type: none"> • Check that the date/time are set correctly and, if they are not, set them. Subsequently arrange to completely switch off the inverter (on both AC and DC) and wait a few minutes. Finally, restart the inverter and check whether the date/time are now correctly set or whether they have reset to 01/01/2000. In this case replace the battery with the inverter completely switched off (section AC and DC side) being careful to maintain the polarity
- W013 * - Clock Fail -  Alarm LED lamp. *not visualised on display	Clock Fail: The alarm occurs when there is a difference of over 1 minute in the time displayed compared to the internal time of the microprocessors and indicates a malfunction of the clock circuit.	<ul style="list-style-type: none"> • completely switch off the inverter (on both AC and DC) and wait a few minutes. Finally, restart the inverter and check whether the date/time are now correctly set or whether they have reset to 01/01/2000. In this case replace the battery with the inverter completely switched off (section AC and DC side) being careful to maintain the polarity. - If the alarm repeats persistently, contact customer assistance.
- W015 - Island Detect. -  Alarm LED	Disconnection due to Anti-Islanding: The inverter has been improperly connected to an island grid.	<ul style="list-style-type: none"> • Check that the grid to which the inverter is connected is not an island grid. - If the grid to which the inverter is connected is an island grid, switch the inverter off and then on again: if the problem persists, contact customer assistance.
- W017* - String Err. -  Alarm LED lamp. * (only for models with monitored string fuses)	Error recorded in measuring string currents: Damaged string protection fuse(s)	<ul style="list-style-type: none"> • Check with a multimeter the state of the fuses (positioned on the fuse boards). - If one or more fuses is open, arrange to replace them and check that the input current on the string(s) does not exceed the rating of the fuses (should parallel strings have been made outside the inverter). - If there are no damaged string fuses and the inverter continues to show the alarm message check whether the settings to be made through the Aurora Manager software are correct (presence or absence of one or more input strings).
- W018 * - SPD DC Err -  Alarm LED lamp. * (only for models with monitored SPD)	Intervention of overvoltage surge arresters on DC side: Damaged overvoltage surge arresters positioned on DC side	<ul style="list-style-type: none"> • Observe the inspection window on each surge arrester (DC side). If it is red, the surge arrester is damaged and the cartridge must be replaced. - If the alarm status persists, even if all the surge arresters have a green inspection window, contact customer assistance.
- W019 * - SPD AC Err -  Alarm LED lamp. * (only for models with monitored SPD)	Intervention of overvoltage surge arresters on AC side: Damaged overvoltage surge arresters positioned on AC side	<ul style="list-style-type: none"> • Observe the inspection window on each surge arrester (AC side). If it is red, the surge arrester is damaged and the cartridge must be replaced. - If the alarm status persists, even if all the surge arresters have a green inspection window, contact customer assistance.
- W022 * - Reactive power mode changed -  No LED *not visualised on display	Variation in means of managing reactive power: Variation in the means of managing reactive power; this change can be made through the display or advanced configuration software.	The variation in the means of managing reactive power is done directly by the customer/installer and is not an error. The information is only saved on the historic record of the events memorized by the inverter
- W023 * - date/time changed -  No LED *not visualised on display	Variation in the inverter's date and time: Variation of the inverter's date and time; this change can be made through the display or advanced configuration software.	<ul style="list-style-type: none"> • The variation in the inverter's date and time is done directly by the customer/installer and is not an error. The information is only saved on the historic record of the events memorized by the inverter
- W024 * - Energy data reset -  No LED *not visualised on display	Zeroing of the statistical energy data memorized in the EEPROM: Reset of the energy data saved in the inverter; this operation can be handled through the display or advanced configuration software.	The zeroing of the partial energy values memorized by the inverter is done directly by the customer/installer and is not an error. The information is only saved on the historic record of the events memorized by the inverter <ul style="list-style-type: none"> • The notice may also occur on substitution of the Memory Card where the statistical production data is saved





















- Code on display - Error message - Signal	Name of Alarm and Cause	Solution
- W026 * - AFDD user reset - ⊗ No LED *not visualised on display	Reset of the Arc Fault error: Manual reset of the Arc Fault error; this operation can be made through the display or advanced configuration software.	<ul style="list-style-type: none"> The reset of the Arc Fault error is done directly by the customer/installer and is not an error. The information is only saved on the historic record of the events memorized by the inverter
- W027 * - Latch-Manual reset - ⊗ No LED *not visualised on display	Resetting of the Latch alarm conditions: Manual reset of the Latch alarm conditions; this operation can be made through the display or advanced configuration software.	<ul style="list-style-type: none"> The reset of the Latch alarm conditions is done directly by the customer/installer and is not an error. The information is only saved on the historic record of the events memorized by the inverter
- W046 - Grid conn. fault - ● Alarm LED	Connection to the grid unsuccessful The alarm is logged when a Missing grid or Input UV error occurs or due to the manual disconnection of the inverter during the grid connection sequence.	<ul style="list-style-type: none"> Once the error occurs, the inverter tries to return to normal operation. If the problem persists after a number of attempts to connect the inverter, switch the inverter off and then on again. If the problem persists (once the inverter has been switched off and back on again), contact customer assistance.
- W047 - Update Incomplete - ● Alarm LED	FW update method unsuccessful The alarm occurs when a firmware update has not been completed.	<ul style="list-style-type: none"> Complete any pending firmware updates. If the problem persists once the firmware updates have been completed, switch the inverter off and on again. If the problem persists (once the inverter has been switched off and back on again), contact customer assistance.
- W048 - Periodic GridOff - ● Alarm LED	Automatic disconnection from the grid due to time limit: If the inverter exceeds the set grid connection time limit set by the grid standard, it will automatically have to carry out a disconnection and reconnection to the grid to carry out the Riso test.	<ul style="list-style-type: none"> The presence of this alarm is not an error as the automatic disconnection is prescribed by safety regulations. If the inverter disconnects in a shorter time than expected, contact customer assistance.
- W049 * - Global-Settings Event - ⊗ No LED *not visualised on display	Variation of the grid standard Variation of the inverter's grid standard; this change can be made through the display or advanced configuration software.	<ul style="list-style-type: none"> The variation in the inverter's grid standard is done directly by the customer/installer and is not an error. The information is only saved on the historic record of the events memorized by the inverter
- W058 - System Frozen - ● Alarm LED	Converter in locked state: The converter lock state is connected to an installation phase in which the starts-up and grid connection conditions are not yet present.	<ul style="list-style-type: none"> Complete the commissioning phase of the inverter. If the problem persists (once the commissioning phase has been completed and the inverter has been switched off and back on again), contact customer assistance.
- E001 - Input OC - ● Alarm LED	Input over-current (photovoltaic generator): The alarm occurs when the inverter's input current exceeds the inverter's threshold for maximum input current.	<ul style="list-style-type: none"> Check whether the composition of the PV generator enables input current which exceeds the maximum threshold allowed by the inverter and that the configuration of the inputs (independent or in parallel) is carried out correctly. If both checks are positive, contact customer assistance.
- E002 - Input OV - ● Alarm LED	Input overvoltage (photovoltaic generator): The alarm is generated when the input voltage (from the PV generator) exceeds the inverter's threshold of maximum input voltage. The alarm occurs before reaching the absolute threshold over which the inverter is damaged. When the inverter's input voltage exceeds the overvoltage threshold, the inverter will not start up due to the generation of the alarm.	<ul style="list-style-type: none"> It is necessary to measure the input voltage inside the inverter with a voltmeter. If it is higher than the maximum voltage of the operating range, the alarm is genuine and it is necessary to check the configuration of the PV generator. If the voltage has also exceeded the maximum input threshold the inverter could be damaged. If it is lower than the maximum voltage of the operating range, the alarm is caused by an internal malfunction and it is necessary to contact customer assistance.
- E003 - No Parameters - ● Alarm LED	DSP initialisation error: The main microcontroller cannot initialise correctly the two DSPs (booster stage and inverter stage). The error is caused by communication problems on the inverter's internal bus.	<ul style="list-style-type: none"> Error inside the inverter and cannot be checked externally. If the problem persists (once the inverter has been switched off and back on again), contact customer assistance.
- E004 - Bulk OV - ● Alarm LED	"Bulk" over-voltage (DC-DC circuit): Error inside the inverter. The alarm is raised when the voltage at the heads of the bulk capacitors exceeds the overvoltage threshold (internal unchangeable threshold).	<ul style="list-style-type: none"> The alarm may be triggered by causes external to the inverter: <ul style="list-style-type: none"> An excessive input voltage can be recorded as a condition for bulk overvoltage. In this case it is advisable to check the inverter's input voltage and should this value be close to the input OV threshold, review the configuration of the photovoltaic generator. Excessive grid voltage could cause the bulk voltage to rise in uncontrolled fashion with a consequent protection intervention and hence generation of the alarm. In these cases the alarm is transitory and the inverter automatically restarts The alarm may be triggered by causes inside the inverter and in this case it is necessary to contact customer assistance.



- Code on display - Error message - Signal	Name of Alarm and Cause	Solution
- E005 - Comm.Error - ● Alarm LED	Communication error inside the inverter: The alarm occurs when there are communication problems between the control devices inside the inverter.	• Error inside the inverter and cannot be checked externally. - If the problem (once the inverter has been switched off and back on) persists, contact customer assistance.
- E006 - Output OC - ● Alarm LED	Output overcurrent: The alarm occurs when the inverter's output current exceeds the inverter's threshold for maximum output current.	• Error inside the inverter and cannot be checked externally. - If the problem (once the inverter has been switched off and back on) persists, contact customer assistance.
- E007 - IGBT Sat - ● Alarm LED	Saturation recorded on the IGBT components: The alarm occurs when one of the inverter's active devices is in a saturated state.	Once the error occurs, the inverter tries to return to normal operation. - Should the error occur sporadically, it may be caused by a brusque transition of the grid voltage or of the input voltage, but is not due to a malfunction by the inverter. - If the error is connected to an internal breakdown, it will continue to appear and so it is necessary to contact customer assistance.
- E009 - Internal error - ● Alarm LED	Error inside the inverter: Error inside the inverter	• Error inside the inverter and cannot be checked externally. - If the problem (once the inverter has been switched off and back on) persists, contact customer assistance.
- E010 - Bulk Low - ● Alarm LED	Low "Bulk" voltage (DC-DC circuit): The alarm may be triggered by causes external to the inverter: a reduced input voltage on the inverter (just above the activation voltage) but which is not accompanied by a sufficient availability of power from the photovoltaic generator (typical condition of the stages with limited irradiation)	- If the error signal occurs sporadically, it may be due to causes external to the inverter (limited irradiation and so limited power availability from the PV generator). - If the problem occurs systematically also in conditions of high irradiation and with input voltage which is significantly higher than the activation voltage, contact customer assistance.
- E011 - Ramp Fail - ● Alarm LED	Long wait for "Booster" regime to start: Error internal to inverter relating to start up time for DC-DC circuit regime (Booster)	• Error inside the inverter and cannot be checked externally. - If the problem (once the inverter has been switched off and back on) persists, contact customer assistance.
- E012 - DcDc Fail - ● Alarm LED	Error in the "Booster" circuit (DC-DC side) recorded by the "Inverter" circuit (DC-AC side): Error internal to inverter relating to operation of the DC-DC circuit regime (Booster)	• Error inside the inverter and cannot be checked externally. - If the problem persists (once the inverter has been switched off and back on again), contact customer assistance.
- E013 - Wrong Mode - ● Alarm LED	Incorrect configuration of inputs (set in parallel rather than independent): The alarm is generated solely when the inverter is configured with parallel inputs. In this particular configuration the inverter checks the input voltage of each of the two channels and if the two voltages differ by more than 20Vdc, the alarm is raised .	• Check that the setting of the "IN MODE" switch is specifically set to "PAR" and that the bridges between the two input channels have been included. - If the configuration of the inverter is correct, check that the input strings have the usual number of standard panels of the usual brand and with the same inclination/orientation. - If both the configuration of the inverter and the characteristics of the PV generator conform with the specifications, contact customer assistance.
- E014 - Over Temp. - ● Alarm LED	Excessive temperature inside the inverter: External temperature over 60°C. This parameter also depends on the power which the inverter must supply since the measurement of temperatures is done internally and is influenced by the heat dissipated by the components of the inverter itself	• Check that the inverter is not exposed to direct sunlight. Wait for the temperatures to which the inverter is exposed to return to the operating range and for the inverter to cool down. - If the problem (once the ambient temperature has returned to the range) persists, contact customer assistance. Remember to wait the time needed to allow the inverter to cool down
- E015 - Bulk Cap Fail - ● Alarm LED	Fault recorded on the "Bulk" capacitor: Error inside the inverter relating to a problem in the bulk capacitors.	• Error inside the inverter and cannot be checked externally. - If the problem persists (once the inverter has been switched off and back on again), contact customer assistance.
- E016 - Inverter Fail - ● Alarm LED	Error in the "Inverter" circuit (DC-AC side) recorded by the "Booster" circuit (DC-DC side): The alarm is generated when a problem is recorded in the inverter circuit (DC/AC)	• Error inside the inverter and cannot be checked externally. - If the problem persists (once the inverter has been switched off and back on again), contact customer assistance.
- E017 - Start Timeout - ● Alarm LED	Long wait for "Inverter" regime to start up: Error internal to inverter relating to start-up time for the DC-AC circuit regime (Inverter) • The alarm may be triggered by causes external to the inverter: a reduced input voltage on the inverter (just above the activation voltage) but which is not accompanied by a sufficient availability of power from the photovoltaic generator (typical condition of the stages with limited irradiation)	- If the error signal occurs sporadically, it may be due to causes external to the inverter (limited irradiation and so limited power availability from the PV generator). - If the problem occurs systematically also in conditions of high irradiation and with input voltage which is significantly higher than the activation voltage, contact customer assistance.



- Code on display - Error message - Signal	Name of Alarm and Cause	Solution
- E018 - Ground Fault -  GFI LED	High leakage current measured on the DC side (photovoltaic generator): The alarm is generated when, during normal operation of the inverter, a leakage current to ground is detected in the DC section of the system. It is also possible that the inverter generates the alarm E018 message also due to AC leakage currents connected to the capacitive nature of the photovoltaic generator compared to ground.	<ul style="list-style-type: none"> • Measure the insulation resistance using a megohmmeter positioned in the photovoltaic field (positive terminal short-circuited at the negative pole) compared to ground. The measurement is strongly influenced by the environmental conditions, so must be made under the same conditions in which the error occurred. - If the value measured is lower than 1 megaohm, a check must be carried out by a technician/installer on the photovoltaic generator to identify and eliminate the problem. - If the value measured is higher than 1 megaohm and the error signal persists, contact customer assistance.
- E019 - Ileak sense.fail -  Alarm LED	Failure of test on sensor to measure the leakage current (DC side): Before connecting to the grid the inverter runs a autotest regarding the sensor for the leakage current. The test is carried out by "forcing", in the sensor of the leakage current, a current with a known value: the microprocessor compares the value read with the known value. The error is generated if the comparison between the read value and the known value during the test does not fall within the allowed tolerance.	<ul style="list-style-type: none"> • Error inside the inverter and cannot be checked externally. By its nature, the alarm only occurs prior to connection to the grid - If the problem (once the inverter has been switched off and back on) persists, contact customer assistance.
- E020 - Self Test Error 1 -  Alarm LED	Failure of the test on the relay of the "Booster" (DC-DC circuit): Before connecting to the grid the inverter carries out internal tests. One of these tests concerns the correct operation of the booster relay. The test is carried out by "forcing" the switching of the relay and checking its operation. The error is generated if a problem is found in actioning the relay.	<ul style="list-style-type: none"> • Error inside the inverter and cannot be checked externally. By its nature, the alarm only occurs prior to connection to the grid - If the problem persists (once the inverter has been switched off and back on again), contact customer assistance.
- E021 - Self Test Error 2 -  Alarm LED	Failure of the test on the inverter's relay (DC-AC circuit): Before connecting to the grid the inverter carries out internal tests. One of these tests concerns the correct operation of the inverter relay. The test is carried out by "forcing" the switching of the relay and checking its operation. The error is generated if a problem is found in actioning the relay.	<ul style="list-style-type: none"> • Error inside the inverter and cannot be checked externally. By its nature, the alarm only occurs prior to connection to the grid - If the problem persists (once the inverter has been switched off and back on again), contact customer assistance.
- E022 - Self Test Error 4 -  Alarm LED	Timeout of the tests undertaken on the relays inside the inverter: Execution time for the autotest carried out on the relay of the DC_AC (inverter) circuit too high. It may indicate a problem connected to the aforementioned relays	<ul style="list-style-type: none"> • Error inside the inverter and cannot be checked externally. - If the problem persists (once the inverter has been switched off and back on again), contact customer assistance.
 - E023 - DC in error -  Alarm LED	Feeding of direct current to grid outside of range: The error is generated if the continuous component of the current supplied to the grid exceeds the threshold of 0.5% of the normal operating current. In any case the inverter is not blocked due to the E023 error, but tries to reconnect to the grid. The sporadic repetition of the error is a sign of serious grid distortions or sharp irradiation changes, while systematic repetition of the error signal will indicate a breakdown on the inverter	Once the error occurs, the inverter tries to return to normal operation. <ul style="list-style-type: none"> - Should the error occur sporadically, it may be caused by a brusque transition of the grid voltage or of the input voltage, but is not due to a malfunction by the inverter. - If the error is connected to an internal breakdown, it will continue to appear and so it is necessary to contact customer assistance.
- E024 - Internal error -  Alarm LED	Error inside the inverter: Error inside the inverter	<ul style="list-style-type: none"> • Error inside the inverter and cannot be checked externally. - If the problem persists (once the inverter has been switched off and back on again), contact customer assistance.

- Code on display - Error message - Signal	Name of Alarm and Cause	Solution
- E025* - Riso Low -  Alarm LED *not visualised on display	Low value of insulation resistance: Before connecting to the grid the inverter measures the insulation resistance of the PV generator compared to ground. Should the measurement of the insulation resistance be below 1Mohm, the inverter does not connect to the grid and shows the "Riso Low" error. The causes may be: - PV panel(s) damaged; - Junction box(es) of the panels not correctly sealed, so as to permit infiltration by water and/or humidity; - Problems in connections between panels (not perfectly fit); - Poor quality of cable joints; - Presence in the DC section of unsuitable or damaged overvoltage surge arresters outside the inverter (reduced ignition voltage compared to the characteristics of the strings of the PV generator); - Presence of humidity inside any junction box	<ul style="list-style-type: none"> • Measure the insulation resistance using a megohmmeter positioned in the photovoltaic field (positive terminal short-circuited at the negative pole) compared to ground. The measurement is strongly influenced by the environmental conditions, so must be made under the same conditions in which the error occurred. - If the value measured is lower than 1 megaohm, a check must be carried out by a technician/installer on the photovoltaic generator to identify and eliminate the problem. - If the value measured is higher than 1 megaohm and the error signal persists, contact customer assistance.
- E026 - Vref Error -  Alarm LED	Internal reference voltage outside of range: Wrong measurement of reference voltage inside inverter	<ul style="list-style-type: none"> • Error inside the inverter and cannot be checked externally. - If the problem persists (once the inverter has been switched off and back on again), contact customer assistance.
- E027 - Error Meas V -  Alarm LED	Grid voltage outside of range: Error in the internal measurement of grid voltage (set by law) in order to have a redundant measurement (2 measurements on the same parameter made by two different circuits)	<ul style="list-style-type: none"> • Error inside the inverter and cannot be checked externally. - If the problem persists (once the inverter has been switched off and back on again), contact customer assistance.
- E028 - Error Meas F -  Alarm LED	Grid frequency outside of range: Error in the internal measurement of grid frequency (set by law) in order to have a redundant measurement (2 measurements on the same parameter made by two different circuits)	<ul style="list-style-type: none"> • Error inside the inverter and cannot be checked externally. - If the problem persists (once the inverter has been switched off and back on again), contact customer assistance.
- E029 - Mid Bulk OV -  Alarm LED	Internal overvoltage on the measurement of the "Mid bulk": Error inside the inverter (only triphase models)	<ul style="list-style-type: none"> • Error inside the inverter and cannot be checked externally. - If the problem persists (once the inverter has been switched off and back on again), contact customer assistance.
- E030 - Error Meas Ileak -  Alarm LED	High leakage current (DC side): Error in the internal measurement (made when the inverter is grid connected) of the leakage current of the DC side (PV generator) compared to ground (set by law) in order to have a redundant measurement (2 measurements on the same parameter made by two different circuits)	<ul style="list-style-type: none"> • Error inside the inverter and cannot be checked externally. - If the problem persists (once the inverter has been switched off and back on again), contact customer assistance.
- E031 - Error Read V -  Alarm LED	Output relay damaged: Measurement of internal voltage on heads of the output relay outside of range. There is too great a difference in voltage between the input and output of the grid connection relay.	<ul style="list-style-type: none"> • Error inside the inverter and cannot be checked externally. - If the problem persists (once the inverter has been switched off and back on again), contact customer assistance.
- E032 - Error Read I -  Alarm LED	Imbalanced output currents: Measurement of the imbalance in the output voltage (carried out across the three phases) outside of range (only in triphase models)	<ul style="list-style-type: none"> • Error inside the inverter and cannot be checked externally. - If the problem persists (once the inverter has been switched off and back on again), contact customer assistance.
- E033 - UTH -  Alarm LED	Low ambient temperature: Temperature outside the inverter below -25°C	<ul style="list-style-type: none"> • Wait for the temperatures to which the inverter is exposed to return to the operating range. - If the problem persists, contact customer assistance. Remember to wait the time needed to allow the inverter to warm up
- E034 - Interlock fail -  Alarm LED	"IGBT" circuitry not ready: Error inside the inverter	<ul style="list-style-type: none"> • Error inside the inverter and cannot be checked externally. - If the problem persists (once the inverter has been switched off and back on again), contact customer assistance.
- E035* - Remote Off -  Alarm LED *not visualised on display	Inverter awaiting "remote ON" command: The inverter has been switched off remotely (remote OFF) and remains awaiting the signal which will switch it back on (Remote ON)	<ul style="list-style-type: none"> • Switch the inverter back on remotely. If the unit does not switch back on, disable the remote off/on function and switch the equipment off completely and subsequently switch it back on. - If the problem persists (once the Remote ON/OFF function from the display has been reactivated), contact customer assistance.



- Code on display - Error message - Signal	Name of Alarm and Cause	Solution
- E036 - Vout Avg error - ● Alarm LED	Average of the measurements of grid voltage outside of range: The average value of the grid voltage (sampled every 10 minutes) does not fall within the permitted ranges. The grid voltage in the point connected to the inverter is too high. This may be caused by too high a grid impedance. In the final stage of the timeout, the inverter limits the power to check whether the grid voltage has stabilised into regular parameters. If this does not happen, the inverter disconnects from the grid	<ul style="list-style-type: none"> • Check the grid voltage in the connection point to the inverter. - If the grid voltage differs from the range due to the conditions of the distribution grid, ask the operator to adjust the grid voltage. If the operator authorises a change to the inverter's parameters, agree the new limits with customer assistance
E046 - String self test fail - ⊗ No LED	Error during the automatic check of the string voltages (only in models with the "fuse-control" board): In some inverter models it is possible to carry out the check test of the polarity of the strings connected to the input (e.g.:TRIO-20.0/27.6kW). This error signal occurs when, during the test stage, an inverted string is recorded	<ul style="list-style-type: none"> • Section the inverter and check the polarity of the string(s) which the inverter has recorded as inverted. - Once all the strings have been correctly connected, activate the system once again; the inverter will once again check the correct polarity of the string inputs at the end of which it will carry out the checks for the grid connection. - If the problem persists (once the inverter has been switched off and back on again), contact customer assistance.
E049 - AC FF Error - ● Alarm LED	Error in the "AC feed-forward" circuit: Error inside the inverter	<ul style="list-style-type: none"> • Error inside the inverter and cannot be checked externally. - If the problem persists (once the inverter has been switched off and back on again), contact customer assistance.
E050 - AFDD Activated - ● GFI LED	Arc Fault protection activated: Possible photovoltaic arc detected on the DC side.	<ul style="list-style-type: none"> • If it is the first time this problem has occurred, press the ESC button for 5 seconds and wait for the unit to restart. - If the problem persists (once the inverter has been switched off and back on again), contact customer assistance.
E053 - AFDD Fault - ● Alarm LED	Arc Fault board autotest failed: Problem detected during the AFDD board autotest phase.	<ul style="list-style-type: none"> • Error inside the inverter and cannot be checked externally. - If the problem persists (once the inverter has been switched off and back on again), contact customer assistance.
E054 - AFDD comm. Fault - ● Alarm LED	Arc Fault board communication error: Error on the RS485 serial communication detected between the inverter and the AFDD board.	<ul style="list-style-type: none"> • Error inside the inverter and cannot be checked externally. - If the problem persists (once the inverter has been switched off and back on again), contact customer assistance.
E055 - AFDD wrong conf. - ● Alarm LED	Arc Fault board parameter reading error: Error in the parameter reading by the system.	<ul style="list-style-type: none"> • Error inside the inverter and cannot be checked externally. - If the problem persists (once the inverter has been switched off and back on again), contact customer assistance.
E056 - Over Temp. (from external box) - ● Alarm LED	Excessive temperature measured inside the inverter's wiring box: High internal temperature. This error relates to the temperature measured on external boxes (e.g.:TRIO-20.0/27.6kW).	<ul style="list-style-type: none"> • Check that the inverter is not exposed to direct sunlight. Wait for the temperatures to which the inverter is exposed to return to the operating range and for the inverter to cool down. - If the problem (once the ambient temperature has returned to the range) persists, contact customer assistance. Remember to wait the time needed to allow the inverter to cool down
 E057 - Vbulk reading error - ● Alarm LED	Input voltage (Vin) higher than booster voltage (Vbulk): The error occurs if the input voltage exceeds the Bulk voltage (voltage on the DC-DC circuit inside the inverter)	<ul style="list-style-type: none"> • It is necessary to measure the input voltage inside the inverter with a voltmeter. - If it is higher than the maximum voltage of the operating range, the alarm is genuine and it is necessary to check the configuration of the PV generator. If the voltage has also exceeded the maximum input threshold the inverter could be damaged. - If it is lower than the maximum voltage of the operating range, the alarm is caused by an internal malfunction and it is necessary to contact customer assistance.
E058 - Pin vs Pout check error - ● Alarm LED	Error in the check of Pin vs Pout: The error occurs if the difference between the measured value of input power and that of output power is greater than the limit imposed internally to the inverter.	<ul style="list-style-type: none"> • Error inside the inverter and cannot be checked externally. - If the problem persists (once the inverter has been switched off and back on again), contact customer assistance.
E077 - Internal Error - ● Alarm LED	Error in the system configuration: Error inside the inverter	<ul style="list-style-type: none"> • Error inside the inverter and cannot be checked externally. - If the problem persists (once the inverter has been switched off and back on again), contact customer assistance.
E078 - Riso Test fail - ● Alarm LED	Riso test error: Problem detected during the Riso test phase.	<ul style="list-style-type: none"> • Error inside the inverter and cannot be checked externally. - If the problem persists (once the inverter has been switched off and back on again), contact customer assistance.
E079 - Wrong Sequence - ● Alarm LED	Incorrect Phases connection (Only triphase models) The phases have not been connected correctly to the AC output	<ul style="list-style-type: none"> • Invert two of the phases of the network wiring to the AC terminal block of the inverter.

- Code on display - Error message - Signal	Name of Alarm and Cause	Solution
E081 - Internal Error - ● GFI LED	Inverter fault / Incomplete inverter closing: Fault inside the inverter or incomplete inverter closing (front cover missing or not tightened, cable glands missing or incorrectly tightened, environmental protection IP65 not guaranteed)	<ul style="list-style-type: none"> • If the problem has occurred during the installation phase or during the inverter maintenance phase (therefore the cover has been removed or the cable glands have been acted upon), carry out the following operations: <ul style="list-style-type: none"> - Disconnect the AC grid and DC input from the inverter and check for the front cover and all the cable glands, also checking their correct tightening to ensure environmental protection IP65; reconnect the AC grid and the DC input and attempt to switch the inverter on; if the problem persists, contact customer assistance : - If the front cover and all cable glands are present, disconnect the AC grid and DC input from the inverter and wait 15 minutes at a safe distance, then open the inverter cover and if no smoke/smell of burning is present, check the integrity of the components or the presence of moisture or other abnormal conditions; reconnect the AC grid and DC input and attempt to switch on the inverter; if the problem persists contact customer assistance. • If the problem has occurred after installation or after an inverter maintenance phase (therefore the cover has NOT been removed or the cable glands have NOT been acted upon), disconnect the AC grid and the DC input from the inverter and contact customer assistance.
E084 - BackFeed OC - ● Alarm LED	Return current to photovoltaic field: The error occurs if the input voltage is particularly low (typically in the evening in conditions of low irradiation) and indicates a return current from the inverter to the photovoltaic panels).	If the error occurs in the evening or in conditions of low irradiation, it must not be considered a problem but a protection intervention for the photovoltaic field. - If the problem occurs with good irradiation conditions, switch the inverter off and back on again; if the error persists, contact customer assistance.
E089 - Wrong Wiring - ● Alarm LED	Incorrect grid wiring connection on Stand Alone: The error occurs if the grid cables have been incorrectly connected to the Stand Alone output.	<ul style="list-style-type: none"> • Check that the cables on the Stand Alone output have been installed correctly.



Power limitation messages

The equipment can signal possible output power limitations which may occur on the basis of:

- settings made by the user
- settings required by the grid standard of the country of installation
- protective devices inside the inverter

The messages are shown on the display.

The following table gives the complete list of power limitation messages relating to string inverters. Some messages may not be used depending on the inverter model installed.

- Message on display	Name of Derating and Cause	Solution
- LIMxxx% CODE:00	<p>Power limitation: The message indicates that the user has set an output power limitation for the inverter. LIM xxx% = Power reduction percentage Examples: LIM 100% = no power limitation LIM 50% = limitation to 50% of the output nominal power</p>	<ul style="list-style-type: none"> • Check the limitation value set in the "Settings > Power Reduction" menu
- LIMxxx% CODE:01	<p>Power limitation for over-frequency: The message indicates that the user has set a power limitation due to over frequency in order to reduce the maximum output power of the inverter when the grid frequency exceeds certain limits. LIM xxx% = Power reduction percentage Examples: LIM 100% = no power limitation LIM 50% = limitation to 50% of the output nominal power</p>	<ul style="list-style-type: none"> • Check the limitation value set in the "Settings > Service Power > OF Derating" menu
- LIMxxx% CODE:02	<p>Power limitation for over-voltage: The message indicates that the user has set a power limitation due to overvoltage (parameter U >(10 min)) in order to reduce the maximum output power of the inverter when the reading of the average grid voltage exceeds certain limits. The sampling of readings is done every 10 minutes (U >(10min)). LIM xxx% = Power reduction percentage Examples: LIM 100% = no power limitation LIM 50% = limitation to 50% of the output nominal power</p>	<ul style="list-style-type: none"> • Check the limitation value set in the "Settings > Service Power > U > (10 min) Der." menu
- LIMxxx% CODE:03	<p>Anti-islanding power limitation: The message indicates that a power limitation is active since an "islanding" condition has been recorded. LIM xxx% = Power reduction percentage Examples: LIM 100% = no power limitation LIM 50% = limitation to 50% of the output nominal power</p>	<ul style="list-style-type: none"> • If the inverter remains connected to the grid and the limitation is active, contact customer assistance
- LIMxxx% CODE:04	<p>Power limitation due to low grid voltage: The message indicates that an output power limitation may occur since a low grid voltage (AC) condition has been recorded. LIM xxx% = Power reduction percentage Examples: LIM 100% = no power limitation LIM 50% = limitation to 50% of the output nominal power</p>	<ul style="list-style-type: none"> • Check that the grid voltage is lower than the minimal voltage. Should this condition persist, contact the grid operator to resolve the problem.



- Message on display	Name of Derating and Cause	Solution
- LIMxxx% CODE:05	<p>Power limitation due to excess temperature: The message indicates that a power limitation is active since an excess temperature condition has been recorded inside the inverter (This parameter depends also on the power which the inverter must provide since the measurement of temperatures is taken internally and is influenced by the heat dissipated by the components of the inverter itself). LIM xxx% = Power reduction percentage Examples: LIM 100% = no power limitation LIM 50% = limitation to 50% of the output nominal power</p>	<ul style="list-style-type: none"> • Check that the inverter is not exposed to direct sunlight. Wait for the temperatures to which the inverter is exposed to return to the operating range and for the inverter to cool down. - If the problem (once the ambient temperature has returned within the range) persists, contact customer assistance.
- LIMxxx% CODE:06	<p>Power limitation for input over-voltage: The message indicates that a power limitation is active since an input overvoltage (DC) has been recorded. LIM xxx% = Power reduction percentage Examples: LIM 100% = no power limitation LIM 50% = limitation to 50% of the output nominal power</p>	<ul style="list-style-type: none"> • It is necessary to measure the input voltage inside the inverter with a voltmeter. - If it is higher than the maximum voltage of the operating range, the alarm is genuine and it is necessary to check the configuration of the PV generator. If the voltage has also exceeded the maximum input threshold the inverter could be damaged. - If it is lower than the maximum voltage of the operating range, the alarm is caused by an internal malfunction and it is necessary to contact customer assistance.



Dismantling the inverter



Before attempting any work on the inverter, wait for stored energy to be discharged and for parts to cool.

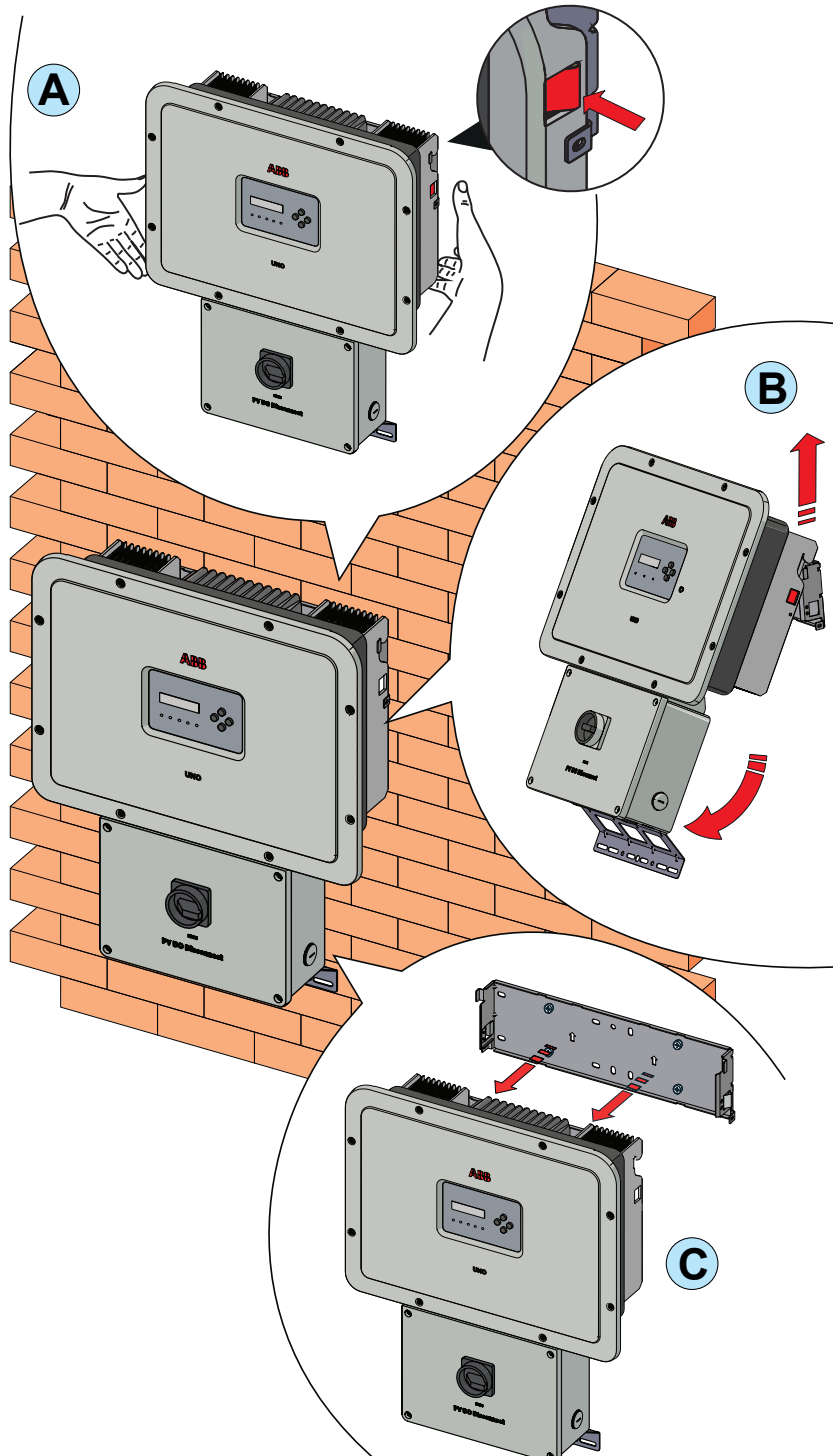

- Open the external DC and AC disconnects switches.

- Disconnect any power supplies that may be connected to the UNO-DM-COM KIT or UNO-DM-PLUS-ETHERNET COM KIT.

- Disconnect any cables from the inverter:
 - DC cables
 - AC cables
 - Any cables that may be connected to the UNO-DM-COM KIT or UNO-DM-PLUS-ETHERNET COM KIT

- Disconnect any conduits from the inverter.

- Remove the screw on the lower bracket used to secure the inverter to the wall or frame.

- Proceed to unlock the inverter from the bracket by pushing the two lock springs 02 (one for each side of the inverter) and pulling forward the lower part of the inverter, at the same time (figures A and B).

- Remove the inverter from the wall bracket pulling it up (figures B and C).



Calculation of second-level password (Service menu, Admin Plus)

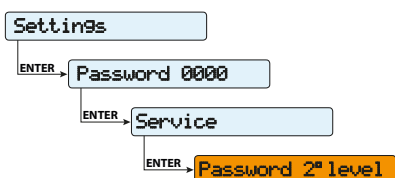

In order to obtain the second-level password needed to access the inverter's display service menu or to obtain the "Admin Plus" privileges in the internal webserver, contact ABB Technical Sales (1-877-261-1374) keeping the following information on hand:

- **S/N** - Serial number of the inverter. This information can be found on the product label giving the identity details of the inverter or on the display by accessing the "Inverter > Info > Serial No."

The serial number consists of 6 digits (the last 6 in models with a label giving a 10-digit S/N)

- **WK** - Production week. This information can be found on the product label giving the identity details of the inverter or on the display by accessing the "Inverter > Info > Serial No."

The production week consists of 4 figures, indicating the week (first 2 digits) and the year of production (last 2 digits)

- **Update Version** - This information is available only for some inverter models and can be found on the display by accessing the menu "Inverter > Info > Firmware".



The password obtained enables access also to the advanced "Installer" mode present on the configuration software for inverters (Aurora Manager LITE). The configuration software can be downloaded in a specific section of the website www.abb.com/solarinverters.



Resetting the remaining time for grid standard variation from display

From the moment a valid grid standard is set and the inverter is switched on, there is a time period of 24 hours available in which modifications to the grid standard setting can be made.



The 24 hours are only counted while the inverter is switched on. Check that the date and time are correctly set. If these settings are incorrect, it may not be possible to access the "Reset Country" menu which allows the timer to be reset.

Once this period has passed, changing the standard will be "blocked" and it will be necessary to carry out the following procedure to reset the remaining time and once again, have 24 hours of operation available in which to select a new grid standard.



You can check how much time remains before the "Country Select" button is blocked, by accessing the menu SYSTEM > SETTINGS > Country Select. > Residual Time.



1. Access the "SYSTEM > SETTINGS" menu by entering the first level password (default **0000**)

2. Access the "Country Select" submenu. > Reset Country" entering the second level password to restore the 24 hours of operation in which it is possible to change the grid standard.



The password required for accessing the "Service" menu can be obtained following the instruction on "Calculation of second-level password (Service menu, Admin Plus)" paragraph



3. After having reset the timer, it will be possible to change the grid standard with the one required in the menu SYSTEM > SETTINGS > Country Select. > Set Std.

Verification of ground leakage

In the presence of anomalies or report of ground fault (where provided), there may be a ground leakage from the PV generator (DC side).

To check this, measure the voltage between the positive pole and ground and between the negative pole (of the PV generator) and ground using a voltmeter whose input accepts a voltage of at least 1000 Volts.

Behavior of a system without leakage

Due to the capacitive effect of the PV generator, during the first moments that the voltmeter is connected between one of the two poles and ground, it will measure a voltage of about $V_{oc}/2$, which will tend to stabilize around 0V if there is no ground leakage, as shown in the graph below:

The internal resistance of the voltmeter tends to zero the voltage present on the PV generator due to the capacitive effect.

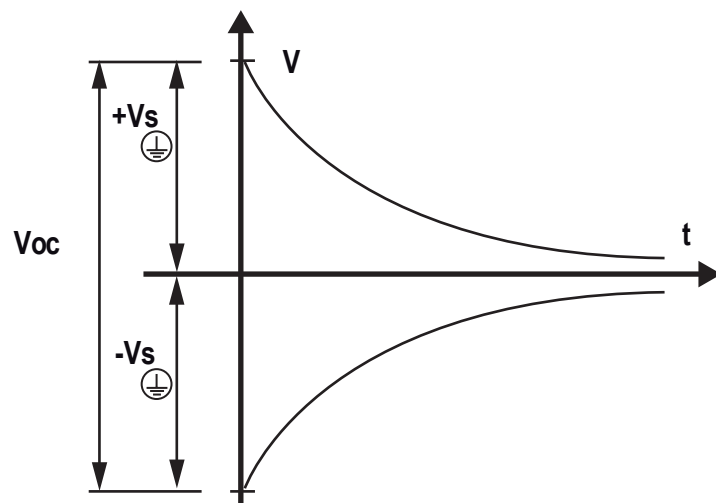

How to make the measurement:

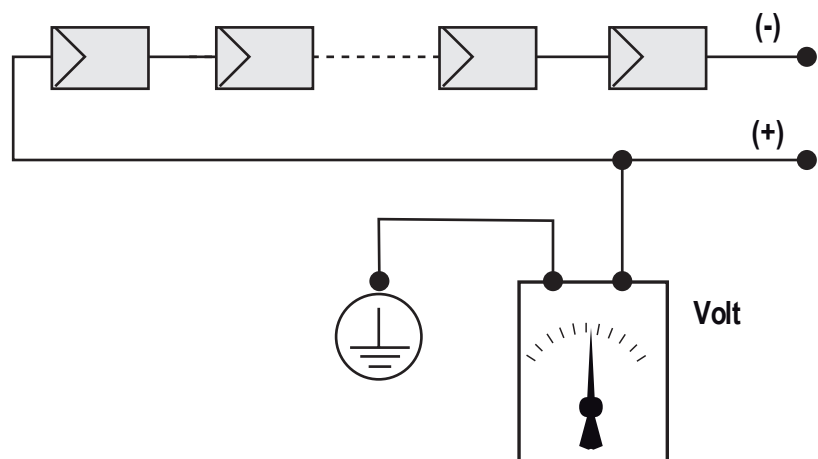

Behavior of a system with leakage

If the voltage measured between one of the two poles and ground does not tend to 0V and stabilizes on a value, there is a ground leakage from the PV generator.

Example: When the measurement is made between positive pole and ground, a voltage of 200V is measured.

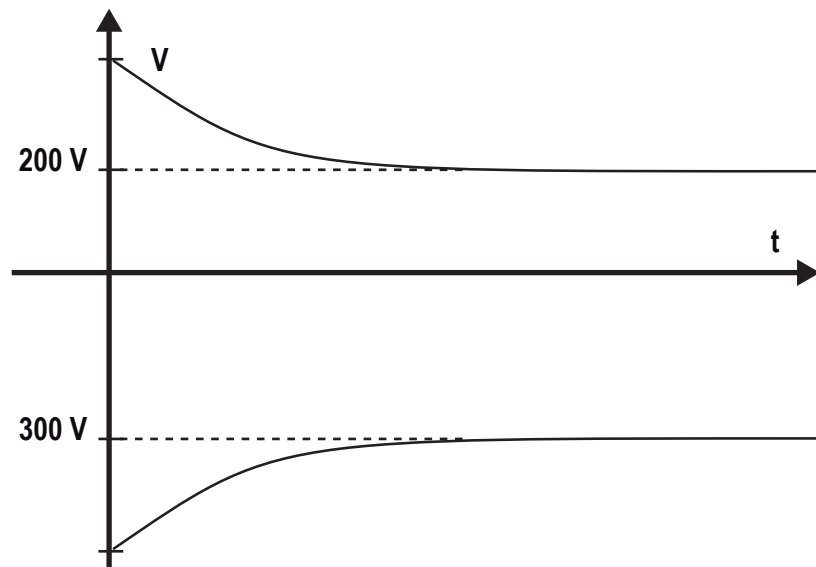

This means that if the system is made up of 10 modules in series and each one supplies 50V, the leakage can be located between the 4th and 5th PV module.

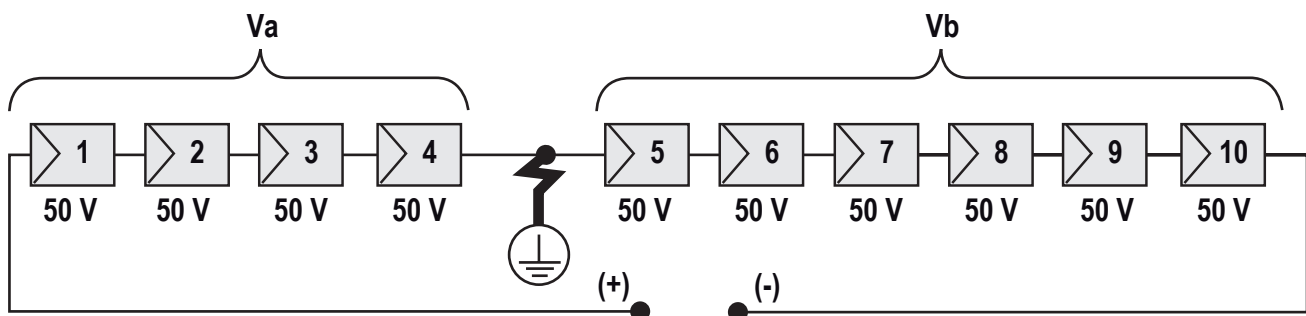

V_a = voltage measured between + pole and \oplus = 200V

V_b = voltage measured between - pole and \oplus = 300V

In all measurements with \oplus , the ground of the inverter is indicated.

Measuring the insulation resistance of the PV generator.

To measure the insulation resistance of the PV generator compared to ground \oplus , the two poles of the PV generator must be short-circuited (using a suitably sized selector).

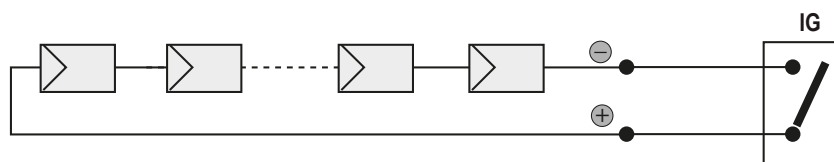

Once the short-circuit has been made, measure the insulation resistance (Riso) using a megohmmeter positioned between the two shorted poles and ground (of the inverter).

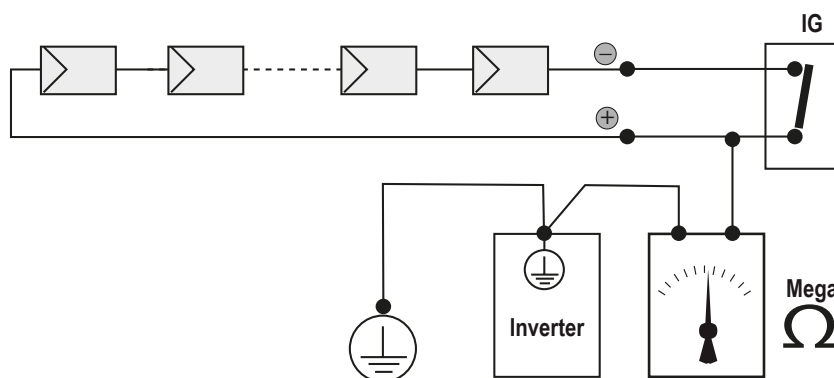

MODELS - TL (without insulation transformer). If the measured insulation resistance (Riso) is less than 500 MOhm, the inverter may not connect to the grid because of low insulation of the PV generator to ground.

MODELS - I (with insulation transformer). If the measured insulation resistance (Riso with floating input poles compared to ground or QF=1 with grounding of one of the two inlet poles) is lower than 0.2 MOhm, the inverter will not connect to the grid due to low insulation of the PV generator to ground.

The insulation resistance can be affected by the environmental conditions the PV generator is in (E.g.: PV modules wet from damp or rain), and therefore the measurement must be made immediately after the anomaly is detected



Storage and dismantling

Storage of an uninstalled inverter for long periods

If the inverter is to be stored for a long period of time before installation, check that it is correctly packed.

The equipment must be stored in well-ventilated, indoor areas, in a non-corrosive environment that doesn't damage the inverter's components.

Have the inverter inspected before installation -- interior components, covers and gaskets.

Storage of an installed inverter for long periods of non-use

If an inverter in the field is to be left unused, confirm all openings have water tight seals. Securely close all locks. If it's in a humid environment, install desiccant in the interior since the inverter is not seeing heat cycles each day.

Restarting after a long period of non-use requires a thorough inspection of the inverter's interior, exterior and wiring to the PV field and grid (and removal of any desiccant). In some cases, oxidation and dust that has settled inside the equipment must be removed.

Disposal



ABB CANNOT be held responsible for disposal of the equipment (cables, batteries, etc.). The customer must dispose of these items, some of which be harmful to the environment, in accordance with the local regulations

Dispose of the various types of materials at facilities that are suitable for the purpose.

Table: component composition

COMPONENT	CONSTRUCTION MATERIAL
Frame, brackets, supports	Arc-welded steel FE37
Casing or covers	Arc-welded steel FE37, aluminum
Gaskets and seals	Rubber / Teflon / Viton
Electrical cables	Copper / Rubber
Backup battery	Nickel / Lead/ Lithium

Attachments

9

Port and network services used by the inverter

IP Network Services

Any network connected to the inverter must allow traffic to pass on the following ports. Network firewall rules (if present) must allow responses to the inverter over existing TCP connections.

Direction	Service/Port	Protocol	Description
Out	ssh/22	Tcp	For remote debugging by ABB service personnel, the inverter utilizes encrypted SSH Remote Login Protocol. To allow service personnel remote access to the inverter, this port has to be opened in any firewall and forwarded to the inverter. (preferred)
Out	domain/53	Tcp/udp	The inverter must be able to resolve domain names, to ensure scalability and dynamic changes on the Internet (DNS). (required)
Out	https/443	Tcp	As an HTTP client, the inverter uses SSL/TLS protocol connections to Aurora Vision [®] servers for secure communication. The inverter uses this port for all services, including data transmission, firmware upgrade, configuration management, and remote command transmission. (required)
Out	dhcp/67, dhcp/68	Udp	If DHCP service is not available, static network information must be assigned to the inverter (preferred)
Out	ntp/123	Udp	The inverter uses this port for network time services (NTP). (preferred)



Network Hosts

The inverter will connect to the following hosts. Some servers owned by ABB, and others are customer or ISP servers. Servers listed as owned by "Customer IT/ISP" must be configured in the inverter using either DHCP or as static network information.

Host	Purpose	Port	Owner/Manager
platform.auroravision.net	Data, configuration	TCP:443	ABB
gw1.auroravision.net and/or apt.fatspaniel.net	Inverter firmware upgrade	TCP:443	ABB
Site dependent	DHCP (optional)	UDP:67, UDP:68	Customer IT/ISP
Site dependent	DNS	UDP:53, TCP:53	Customer IT/ISP

Inverter network configuration

The inverter requires a valid network configuration in order to operate. This information can either be provided by a DHCP server provided by the customers network (the default), or the inverter can be configured with static network information. Regardless of how the inverter is configured, the following information is required.

Configuration	Purpose
IP Address	Allows the inverter to take part in the local network. This does not need to be a public IP address. In most cases this is a private IP address.
Subnet mask	Used to determine if two computers are on the same network.
Gateway	The IP address of the computer which will forward network traffic from the local network to an external network
DNS Server	The IP address(es) of the computer(s) which resolve domain names.



Further information

For further information on ABB products and services for solar systems, please refer to www.abb.com/solarinverters

Contact us

www.abb.com/solarinverters

