



Product Manual

# **PVS-60-TL-US**

## IMPORTANT SAFETY INSTRUCTIONS



*This manual contains important safety instructions that must be followed during the installation and maintenance of the equipment.*

## SAVE THESE INSTRUCTIONS!



*Keep this document in a safe place near the inverter for easy access during installation, operation and maintenance.*

## THE INSTALLER MUST READ THIS DOCUMENT IN ITS ENTIRETY BEFORE INSTALLING THIS EQUIPMENT.

*Operators are required to read this manual and scrupulously follow the instructions given in it, since FIMER cannot be held responsible for damage caused to people and/or things, or the equipment, if the conditions described below are not observed.*

*The purpose of this document is to support the qualified technician, who has received training and/or has demonstrated skills and knowledge in construction, to install, operate and maintain the inverter. This manual covers only inverter, not any equipment (photovoltaic modules, external disconnects, etc) to which it is connected.*

*Warranty requirements are included in the Terms and Conditions of sale included with the inverter order.*

*NOTE: Any changes made to the product or to the installation conditions that hasn't been approved by FIMER will void the warranty.*



*All pictures and illustrations shown in this user manual are indicatives and must be intended as support for installation instruction only. Actual product may vary due to product enhancement. Specifications subject to change without notice. The latest version of this document is available on the FIMER website.*

## FCC REMARKS

*The equipment has been tested and found to comply with the limits for a Class B digital device, pursuant to Part 15 of the FCC Rules. These limits are designed to provide reasonable protection against harmful interference in a residential installation. This equipment generates, uses and can radiate radio frequency energy and, if not installed and used in accordance with the instructions, may cause harmful interference to radio communications.*

*However, there is no guarantee that interference will not occur in a particular installation. If this equipment does cause harmful interference to radio or television reception, which can be determined by turning the equipment off and on, the user is encouraged to try to correct the interference by one or more of the following measures:*

- Reorient or relocate the receiving antenna.*
- Increase the separation between the equipment and receiver.*
- Connect the equipment into an outlet on a circuit different from that to which the receiver is connected.*
- Consult the dealer or an experienced radio/TV technician for help.*



*The products are designed to be connected to and to communicate information and data via a network interface. It is the user's sole responsibility to provide and continuously ensure a secure connection between the product and the user's network or any other network (as the case may be). The user shall establish and maintain any appropriate measures (such as but not limited to the installation of firewalls, application of authentication measures, encryption of data, installation of anti-virus programs, etc) to protect the product, the network, its system and the interface against any kind of security breaches, unauthorized access, interference, intrusion, leakage and/or theft of data or information. FIMER and its affiliates are not liable for damages and/or losses related to such security breaches, any unauthorized access, interference, intrusion, leakage and/or theft of data or information. The data, examples and diagrams in this manual are included solely for the concept or product description and are not to be deemed as a statement of guaranteed properties. All persons responsible for applying the equipment addressed in this manual must satisfy themselves that each intended application is suitable and acceptable, including that any applicable safety or other operational requirements are complied with. In particular, any risks in applications where a system failure and/or product failure would create a risk for harm to property or persons (including but not limited to personal injuries or death) shall be the sole responsibility of the person or entity applying the equipment, and those so responsible are hereby requested to ensure that all measures are taken to exclude or mitigate such risks. This document has been carefully checked by FIMER but deviations cannot be completely ruled out. In case any errors are detected, the reader is kindly requested to notify the manufacturer. Other than under explicit contractual commitments, in no event shall FIMER be responsible or liable for any loss or damage resulting from the use of this manual or the application of the equipment.*

## **Product manual**

### **PVS-60-TL-US string inverters**

#### **1 - Safety and accident prevention**

#### **2 - Introduction and general information**

#### **3 - Characteristics**

#### **4 - Lifting and transport**

#### **5 - Installation**

#### **6 - Instruments**

#### **7 - Operation**

#### **8 - Maintenance**

#### **9 - Attachments**

# Table of Contents

Table of Contents.....	5
<b>Safety and accident prevention .....</b>	<b>9</b>
<b>Safety information and instructions .....</b>	<b>9</b>
<b>Symbols and signs.....</b>	<b>10</b>
<b>Installation and maintenance safety .....</b>	<b>11</b>
General safety information.....	11
Environmental conditions and risks .....	11
Electrical and thermal safety.....	12
Clothing and protection of personnel.....	13
<b>Residual risks .....</b>	<b>14</b>
Table of residual risks .....	14
<b>Introduction and general information.....</b>	<b>15</b>
<b>Warranty and supply conditions.....</b>	<b>15</b>
Not included in the supply.....	15
<b>Scope and target audience.....</b>	<b>16</b>
Purpose and document structure .....	16
List of appendix documents.....	16
Operator and maintenance personnel skills/prerequisites .....	16
<b>Application area, general conditions .....</b>	<b>17</b>
Intended or allowed use.....	17
Limits in field of use.....	17
Improper or prohibited use .....	17
<b>Characteristics .....</b>	<b>18</b>
<b>General conditions .....</b>	<b>18</b>
<b>Models and range of equipment.....</b>	<b>19</b>
Identification of the equipment and manufacturer .....	20
<b>Component reference designators.....</b>	<b>22</b>
Inverter (external view) .....	23
Inverter (internal view) .....	25
Communication board.....	26
Principal inverter components .....	27
<b>Characteristics and technical data.....</b>	<b>28</b>
Tightening torques .....	30
Cable gland clamping range and conduit openings diameter .....	30
Overall dimensions .....	31
Mounting bracket .....	32
<b>Efficiency curves .....</b>	<b>33</b>
<b>Automatic power limiting (Power Derating) .....</b>	<b>34</b>
Power derating due to environmental conditions .....	34
Power reduction due to the input voltage .....	35
Power reduction due to the grid voltage.....	35
P- Q curve capability.....	36

<b>Characteristics of a photovoltaic generator.....</b>	<b>37</b>
Strings and arrays .....	37
<b>Description of the equipment.....</b>	<b>38</b>
Operating diagram (example) .....	38
Mutual connection of multiple inverters .....	39
Notes on the system sizing.....	39
<b>Functionality and components of the equipment.....</b>	<b>40</b>
<b>Communication connection diagrams.....</b>	<b>43</b>
Communication interface .....	43
Ethernet bus connection .....	43
Topographic diagram of the equipment .....	45
<b>Safety devices.....</b>	<b>47</b>
Anti-Islanding .....	47
Ground fault of the photovoltaic panels .....	47
String fuses .....	47
Overvoltage surge arresters .....	47
Other safeguards .....	47
<b><i>Lifting and transport.....</i></b>	<b>48</b>
<b>General conditions .....</b>	<b>48</b>
Transport and handling .....	48
Lifting.....	48
Unpacking and checking .....	48
Storage.....	49
Weight of the modules of the equipment.....	49
Types of lifting .....	49
List of components supplied .....	50
<b><i>Installation .....</i></b>	<b>51</b>
<b>Installation warnings .....</b>	<b>51</b>
<b>Installation planning.....</b>	<b>52</b>
Sizing the ground cable(s) .....	52
Choice of grid output connection type (AC side) .....	53
Sizing the AC cable.....	53
AC overcurrent protection .....	54
sizing the configurable relay (ALARM and AUX).....	54
String Fuse sizing (-S / -SC models) .....	55
Installation procedure for quick-fit connectors .....	57
Installation site and position.....	59
Wireless signal environmental checks.....	61
Installations above 2000 meters .....	62
Installations with a high level of humidity .....	62
<b>Mounting of the inverter on the bracket .....</b>	<b>63</b>
<b>Installing the ground cable(s) .....</b>	<b>66</b>
<b>Grid output connection (AC side).....</b>	<b>67</b>
Connection to the AC terminal block .....	67

<b>Operations preliminary to the connection of the PV generator</b> .....	<b>68</b>
Confirm the PV arrays have no ground leakage .....	68
Measuring the insulation resistance of the PV array .....	70
Confirm string voltage and correct polarity .....	70
Independent or parallel input channels configuration .....	71
Channel configuration examples .....	72
Independent channel configuration (default configuration) .....	73
Parallel channel configuration .....	73
<b>DC input connection</b> .....	<b>74</b>
PVS-60-TL-US - PV input connection .....	75
PVS-60-TL-S-US _ PV input connection .....	76
PVS-60-TL-SC-US _ PV input connection .....	77
<b>Communication and control board</b> .....	<b>78</b>
<b>Connections to the communication and control board</b> .....	<b>79</b>
<b>Ethernet connection configuration</b> .....	<b>80</b>
Ethernet connection .....	81
Serial Communication connection - Slave (RS485-1, RS485-2) .....	83
Serial Communication connection - Slave/Master (RS485-MAIN) .....	86
Remote control connection .....	87
Configurable Relay connection (ALARM and AUX) .....	87
<b>Front cover closure</b> .....	<b>88</b>
<b>Instruments</b> .....	<b>89</b>
<b>General conditions</b> .....	<b>89</b>
<b>Overview of front panel LED functions</b> .....	<b>90</b>
<b>Arc fault reset button</b> .....	<b>91</b>
<b>User interface</b> .....	<b>92</b>
Measurement tolerance .....	92
<b>Operation</b> .....	<b>93</b>
<b>General conditions</b> .....	<b>93</b>
<b>Commissioning</b> .....	<b>94</b>
Commissioning via Installer for Solar Inverters mobile APP .....	95
Commissioning Via Web UI - Wireless connection .....	99
<b>LED behaviour</b> .....	<b>107</b>
<b>Grid support functions</b> .....	<b>109</b>
<b>Description of the Web User Interface</b> .....	<b>111</b>
Access to the Web User Interface .....	111
Web User Interface menu structure.....	114
MAIN section.....	115
SETTING section .....	116
Inverter Log .....	120
USER section.....	121
NETWORK Services .....	122
Service TOOLS .....	129
INFORMATION .....	135

<b>Maintenance</b> .....	<b>136</b>
<b>General conditions</b> .....	<b>136</b>
<b>Inverter total de-energization and safe access</b> .....	<b>137</b>
Operator and maintenance personnel skills/prerequisites .....	137
Clothing and protection of personnel .....	138
Safety equipment and tools .....	138
Inverter total de-energization and safe access procedure .....	139
Routine maintenance .....	148
<b>Troubleshooting</b> .....	<b>149</b>
Internal Webserver and wireless communication troubleshooting .....	149
Alarm Messages of the Inverter .....	151
Power limitation messages .....	160
<b>Procedure for dismantling the Inverter</b> .....	<b>162</b>
<b>Registration on “Registration” website and calculation of security token (Admin Plus)</b> .....	<b>163</b>
<b>Replacing DC string fuses</b> .....	<b>166</b>
<b>Replacing cooling section</b> .....	<b>168</b>
<b>Replacement of the buffer battery</b> .....	<b>169</b>
<b>Storage and dismantling</b> .....	<b>170</b>
Storage of an uninstalled inverter for long periods .....	170
Storage of an installed inverter for long periods of non-use .....	170
Disposal .....	170
<b>Attachments</b> .....	<b>171</b>
<b>Port and network services used by the inverter</b> .....	<b>171</b>
IP Network Services .....	171
Network Hosts .....	172
Inverter network configuration .....	172
<b>Contact us</b> .....	<b>173</b>



## ***Safety and accident prevention***

# 1

### **Safety information and instructions**

This chapter contains the safety instructions which you must obey when you install and operate the inverter and perform maintenance operations on the inverter. Obey these safety instructions to prevent injury or death, or damage to the equipment.

The instructions provided in the manual do not replace the safety devices and technical data for installation and operation labels on the product, and they do not replace the safety regulations in force in the country of installation.











The operators must read and comply with the technical information and instruction provided in the manual and in the attached documentation.

FIMER accepts no liability for failure to comply with the instructions for correct installation and cannot be held responsible for the upstream or downstream equipment.

Specific safety information are provided during installation, commissioning and maintenance operation instructions. Always follow the reading order of instruction exactly as described in this manual.

## Symbols and signs

In the manual and/or in some cases on the equipment, the danger or hazard zones are indicated with signs, labels, symbols or icons.

Symbol	Description
	<b>General warning</b> - Important safety information. Indicates a potentially hazardous situation which, if not avoided, could result in death or serious injury.
	<b>Dangerous Voltage</b> - Indicates a potentially hazardous situation, in particular a high voltage, which, if not avoided, could result in death or serious injury. The inverter has high voltages and energy levels.
	<b>Hot parts</b> - Indicates a potentially hazardous situation, in particular a hot surface, which, if not avoided, could result in death or serious injury. Some surfaces in the inverter will become hot during operation and must not be touched until the parts have cooled down.
	Risk of injury due to the weight of the equipment. Take care during lifting and transport
	Ground connection point.
	Rated temperature range.
	Direct current
	Alternating current
	The DC input voltage positive terminal
	The DC input voltage negative terminal

## Installation and maintenance safety

### General safety information



*Do not proceed with installation if the integrity of the equipment is compromised. Do not use the equipment if you find any operating anomalies.*



*Avoid temporary repairs. All repairs should be carried out using only genuine spare parts, which must be installed in accordance with their intended use.*



*The labels affixed on the equipment must strictly NOT be removed, damaged, defaced, hidden, etc. The technical data provided in this manual does not in any case replace that shown on the labels affixed on the equipment*

*Do not do work on the photovoltaic generator, or the inverter, or its input or output cables, when the inverter is connected to an electrical power system, or to the photovoltaic generator.*

*Before performing any maintenance operation on the inverter, follow these steps:*



- **Prepare the work: Do an on-site Risk Assessment or Job Hazard Analysis** (Check for proper tools and PPE for the Job; Engage the person responsible for electrical equipment or system to review single-line, schematics, switching plans; Decide on the appropriate work methods and initiate the permit to work process).
- **Clearly identify the work location and equipment.**
- **Disconnect all sources and Secure against reconnection by means of a 'Lockout/Tagout' procedure to ensure it cannot accidentally become live.**
- **Verify the absence of operating voltage** (This must be by means of a proper test instrument).
- **Complete the permit to work and "Walk the Permit"** (Now we have verified a 'safe working area' it is time to validate the 'Permit to Work' and "Walk the Permit").

**Refer to "Inverter total de-energization and safe access" chapter on this manual to know all detailed necessary steps to safely perform work on the inverter.**

### Environmental conditions and risks



*The device can be installed outdoors, but only in environmental conditions that do not prevent its regular operation. These conditions are listed in the technical data and in the installation chapter.*



*Do not open the front covers of the inverter when it is raining, or when sand or dust can blow into the unit. Water or sand in the inverter can cause damage in the unit. In the risk assessment prior any intervention on the equipment it is of paramount importance to evaluate the weather conditions. Any intervention on the inverter can be done only in case of dry environment. Don't proceed in case of rain (even light) or high humidity.*



*The device is not designed to operate in environments that are particularly inflammable or explosive.*



*In the event of fire, use CO2 extinguishers and auto-extraction systems to extinguish the fire in closed environments.*



*The installer or maintenance technician must always pay attention to the work environment, ensuring that it is well-lit and there is enough room to ensure an escape route.*

## Electrical and thermal safety



**WARNING!** Obey these instructions to prevent injury or death, or damage to the equipment. If you are not a qualified electrician, do not perform any electrical installation or maintenance work.



Obey all installation safety standards. This can require, among other things, the use of personal protection equipment (PPE), such as arc-proof clothing, arc-proof masks, protective footwear, insulating and protective gloves, eye protection and hearing protection. High power inverter installations have high fault currents.



Before you operate on the inverter, isolate the AC line cables from the electrical power system with the AC disconnect switch of the power system transformer (downstream of inverter). Also, isolate the inverter from the photovoltaic generator with the DC disconnect switch of the generator or by other means (upstream of inverter). The internal AC disconnect switch (if present) do not isolate the AC output cables and terminals of the inverter from the electrical power system. The internal DC disconnect switches (if present) do not completely isolate the DC input cables or terminals from the DC voltage supplied by the photovoltaic generator. **Refer to “Inverter total de-energization and safe access” chapter on this manual for further details.**



Do not work on the communication and control signal cables when power is applied to the inverter or to the external control circuits.



Do not perform insulation or voltage withstand tests on the inverter.



FIMER inverters must be earthed via the connection points marked with the protective earth symbol  $\oplus$  and using a cable with an appropriate conductor cross-section for the maximum ground fault current that the generating system might experience.



Do not switch-on the inverter with the front covers open, even during troubleshooting. The inverter front covers act as arc hazard protection. If a highly unlikely arc flash incident occurs when the inverter front covers are open, the arc-flash proof protection equipment might not provide sufficient protection for the operators.



When the device has just been switched off, it may have hot parts as a result of overheating of surfaces (e.g.: transformers, accumulators, coils, etc.) so be careful where you touch.

## Clothing and protection of personnel

NFPA - 70E, article 130.5 standard requires the equipment owner to field-label electrical equipment, to protect both in-house and contract workers from electric shock and arc flash, with labels containing the following information, :

1. Nominal system voltage
2. Arc flash boundary
3. At least one of the following information:
  - a. Available incident energy and the corresponding working distance
  - b. Arc flash PPE category in Table 130.7(C)(15)(a) or Table 130.7(C)(15)(b)

Label requirements are determined by site-specific arc flash studies and depend on the inverter model, types and exact locations of external disconnects upstream and downstream of the inverter, by voltages and power levels at any given installation.

NFPA 70E Article 130.3 states that the analysis must be reviewed at least every 5 years or whenever a major modification occurs. This means that the label should include a date, and the date must be documented.

The system is not ready for commissioning until PPE labels have been installed.



Personnel must not wear clothes or accessories that could start fires or generate electrostatic charges or, in general, clothing that can compromise personal safety.

## Residual risks



Despite the warnings and safety systems, there are still some residual risks that cannot be eliminated.

These risks are listed in the following table with some suggestions to prevent them.

**Table of residual risks**

RISK ANALYSIS AND DESCRIPTION	SUGGESTED REMEDY
Noise pollution due to installation in unsuitable environments or where individuals routinely work and/or animals dwell most of the time.	Reassess the environment or the place of installation.
Suitable local ventilation that does not cause overheating of the equipment and is sufficient not to create discomfort to people in the room.	Restore suitable ambient conditions and air the room.
External weather conditions, water seepage, low temperatures, high humidity, etc.	Maintain ambient conditions suitable for the system.
Overheating of surfaces at temperature (transformers, coils, etc. ) can cause burns.	Use suitable PPE. Wait for the parts to cool down before opening the inverter. Do not restrict cooling openings or heatsinks.
Inadequate cleaning compromises cooling and does not allow the safety labels to be read.	Clean the equipment, labels and work environment
Stored energy in components can generate hazardous discharges.	Ensure components have discharged their energy before working on them.
Inadequate training of staff.	Ask for a supplementary course.
During installation, temporarily mounting the equipment or its components may be risky.	Prevent unauthorized access to the installation area. Use sufficient people and PPE.
Accidental disconnections of the quick-fit connectors with the equipment in operation, or wrong connections, may generate electric arcs	Prevent unauthorized access to the installation area and lock out/tag ou the inverter before working on it.
Use the same brand for the counterparts of the quick-fit connectors installed on the inverter	Mismatched connectors may void the warranty and cause potential damage

### Warranty and supply conditions

The warranty conditions (available on the official FIMER website) are considered to be valid if the Customer adheres to the indications in this manual; any condition deviating from those described herein must be expressly agreed in the purchase order.

*FIMER declares that the equipment complies with the provisions of law currently in force in the country of installation and has issued the corresponding declaration of conformity.*

#### Not included in the supply

*FIMER accepts no liability for failure to comply with the instructions for correct installation and will not be held responsible for systems upstream or downstream of the equipment it has supplied.*



*It is absolutely forbidden to modify the equipment. Any modification, manipulation, or alteration not expressly agreed with the manufacturer, concerning either hardware or software, shall result in the immediate cancellation of the warranty.*

*The customer is fully responsible for any changes made to the system.*

Given the countless array of system configurations and installation environments possible, it is essential to check the following: adequate spaces, suitable for housing the equipment; airborne noise produced based on the environment; possible flammability conditions.

FIMER will NOT be held liable for defects or malfunctions arising from: improper use of the equipment; deterioration resulting from transportation or particular environmental conditions; performing maintenance incorrectly or not at all; tampering or unsafe repairs; use or installation by unqualified persons.

FIMER is not responsible for any loss of the equipment, or part of it, which does not take place on the basis of the regulations and laws in force in the country of installation.

# Scope and target audience

## Purpose and document structure

This operating and maintenance manual is a useful guide that will enable you to work safely and carry out the operations necessary for keeping the equipment in good working order.



*If the equipment is used in a manner not specified in this manual, the protections and the certifications provided by the equipment may be impaired with the consequent loss of warranty.*



*The language in which the document was originally written is ENGLISH; therefore, in the event of inconsistencies or doubts please ask the manufacturer for the original document.*

## List of appendix documents

In addition to this user manual and maintenance you can consult (and download) the product documentation by visiting [www.fimer.com](http://www.fimer.com).



*Part of the information given in this document is taken from the original supplier documents. This document contains only the information considered necessary for the use and routine maintenance of the equipment.*

## Operator and maintenance personnel skills/prerequisites



*Personnel in charge of using and maintaining the equipment must be trained for the described tasks and must reliably demonstrate their capacity to correctly interpret what is described in the manual.*



*For safety reasons, the installation must be performed by qualified installers and/or licensed electricians in accordance with the existing regulations in the country of installation and in accordance to all safety rules for performing electrical works. The installers must have demonstrated skills and knowledge of the inverter's structure and operation.*



*Inverter operation and maintenance by a person who is NOT qualified, is intoxicated, or on narcotics, is strictly forbidden.*



*The customer has civil liability for the qualification and mental or physical state of the personnel who interact with the equipment. They must always use the personal protective equipment (PPE) required by the laws of the country of destination and whatever is provided by their employer.*



## Application area, general conditions

FIMER shall not be liable for any damages whatsoever that may result from incorrect or careless operations.



*You may not use the equipment for a use that does not conform to that provided for in the field of use. The equipment **MUST NOT** be used by inexperienced staff, or even experienced staff if carrying out operations on the equipment that fail to comply with the indications in this manual and enclosed documentation.*

### Intended or allowed use

This equipment is a inverter designed for:  
transforming a continuous electrical current (DC)  
supplied by a photovoltaic generator (PV)  
in an alternating electrical current (AC)  
suitable for feeding into the public distribution grid.

### Limits in field of use

---

*The inverter can be used only with photovoltaic modules which have ground isolated input poles.*

---

*Only a photovoltaic generator can be connected in the input of the inverter (do not connect batteries or other sources of power supply).*

---

*The inverter can be connected to the electricity grid only in countries for which it has been certified/approved.*

---

*The inverter cannot be connected to the DC side in parallel to other inverters.*

---

*The inverter may only be used in compliance with all its technical characteristics.*

---

### Improper or prohibited use



**IT IS STRICTLY FORBIDDEN TO:**

- *Install the equipment in environments subject to particular conditions of flammability or in adverse or disallowed environmental conditions, (temperature and humidity).*
- *Use the equipment with safety devices which are faulty or disabled.*
- *Use the equipment or parts of the equipment by linking it to other machines or equipment, unless expressly provided for.*
- *Modify operating parameters that are not accessible to the operator and/or parts of the equipment to vary its performance or change its isolation.*
- *Clean with corrosive products that could corrode parts of the equipment or generate electrostatic charges.*
- *Use or install the appliance or parts of it without having read and understood the contents of the user and maintenance manual.*
- *Placing any heavy object, sit or stand up on the inverter.*
- *Heat or dry rags and clothing on the parts in temperature. In addition to being hazardous, doing so would compromise component ventilation and cooling.*



### General conditions

A description of the equipment characteristics is provided to identify its main components and specify the technical terminology used in the manual.

This chapter contains information about the models, details of the equipment, characteristics and technical data, overall dimensions and equipment identification.



*The customer/Installer takes full responsibility if, when reading this manual, the chronological order of its presentation provided is not observed. All information is provided considering occasional inclusion of information in previous chapters.*



In certain cases, there may be a need to separately document software functionality or attach supplementary documentation to this manual which is intended for more qualified professionals.

## Models and range of equipment



*The choice of the inverter model must be made by a qualified technician who knows about the installation conditions, the devices that will be installed outside the inverter and possible integration with an existing system.*

Model Number	Description
<b>PVS-60-TL-US</b>	DC terminal block for use with external combiner, DC disconnect switch, Conduit entry, DC and AC surge protection type II, 1 input channel (MPPT), Output conduit
<b>PVS-60-TL-S-US</b>	Input connection on the touch-safe fuse holder (5 pairs for each MPPT), Positive and negative string fuses, DC disconnect switch, ACFI, Conduit entry, DC and AC surge protection type II, 3 input channels default (MPPT), Output conduit
<b>PVS-60-TL-SC-US</b>	15 quick input connections (5 pairs for each MPPT), Positive and negative string fuses, DC disconnect switch, ACFI, DC and AC surge protection type II, 3 input channels default (MPPT), Output conduit
<b>PVS-60-TL-R-US *</b>	DC terminal block for use with external combiner, DC disconnect switch, Conduit entry, DC and AC surge protection type II, 1 input channel (MPPT), Output conduit, equipped with rapid shut down board for external panel level devices (henceforth referred to as "RSD board").
<b>PVS-60-TL-S-R-US *</b>	Input connection on the touch-safe fuse holder (5 pairs for each MPPT), Positive and negative string fuses, DC disconnect switch, ACFI, Conduit entry, DC and AC surge protection type II, 3 input channels default (MPPT), Output conduit, equipped with rapid shut down board for external panel level devices (henceforth referred to as "RSD board").
<b>PVS-60-TL-SC-R-US *</b>	15 quick input connections (5 pairs for each MPPT), Positive and negative string fuses, DC disconnect switch, ACFI, DC and AC surge protection type II, 3 input channels default (MPPT), Output conduit, equipped with rapid shut down board for external panel level devices (henceforth referred to as "RSD board").

\* Must be installed and operated in conjunction with external panel level rapid shut down devices (please refer to local sales representative for a list of compatible devices).

## Identification of the equipment and manufacturer

The technical data provided in this manual does not substitute the data supplied on the labels affixed to the equipment.



The labels affixed to the equipment must NOT be removed, damaged, stained, hidden, etc., for any reason whatsoever; they must be regularly cleaned and always kept in sight.



The labels shown below have to be intended as example only.

The regulatory label contains the following information:

1. Manufacturer
2. Model
3. Rating data
4. Certification mark

1

SOLAR GRID SUPPORT UTILITY INTERACTIVE  
 TRANSFORMERLESS INVERTER  
 MODEL: PVS-60.0-TL-US

UL 1741  
 CSA-C22.2 No. 107.1  
 Country of Origin Italy

DC RATING	
Nominal Input Operating Voltage	720 V ===
Max. Input Voltage	1000 V ===
Range of Input Operating Voltage	360 - 950 V ===
Range of Input Voltage @Full Power	570 - 800 V ===
Max. Input Current	108 A
Max. Input Short Circuit Current (P.V. Panels)	165 A

AC RATING	
Nominal Output Voltage	480/277 V~ 3Ø
Operating Voltage Range	384 - 571 V~
Nominal Output Frequency	60 Hz (factory preset)
Operating Frequency Range	50.0 (*) - 64.0 (†) Hz
Output Power Factor	> 0.995 (‡)
Nameplate Apparent Power (Smax)	60000 VA
Nameplate Active Power (Pmax @cosφ= 1)	60000 W @ 45 °C amb.
Rated Active Power (@Vacr, cosφ= ±0.9)	54000 W
cosφ Adjustability Range	0 - 1 (†)
Max. Output Current (for each phase)	77 A (rms)
Max. Output Overcurrent Protection	100 A

Operating Ambient Temperature: -25 to +60 °C (-13 to +140 °F), with Output Power Derating

Type of Enclosure: NEMA 4X

DC Ground Fault Detector/Interrupter is Provided Photovoltaic Arc-Fault Circuit Protection-Type1

(\*) Adjustable from 50.0 Hz to 59.9 Hz (†) Adjustable from 60.1 Hz to 64.0 Hz

(‡) Adjustable from 0 to 1 under or over @Smax

**For more details about product specifications refer to the Instruction Manual**

**Contains FCC ID: X6W-VSN300S**

This device complies with Part 15 of the FCC Rules. Operation is subject to the following two conditions: (1) this device may not cause harmful interference, and (2) this device must accept any interference received, including interference that may cause undesired operation.

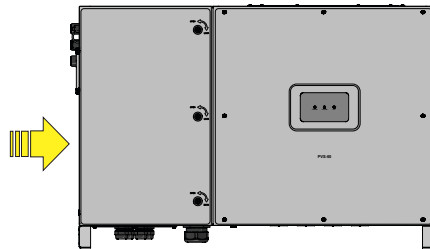

In addition to the label showing the inverter data, there is also the identification label for the inverter:

The label displays the following information:

The diagram shows a rectangular label with the following fields and callouts:

- MODEL NAME**: Callout to the top left text.
- Inverter model**: Callout to the top right text.
- Inverter Part Number**: Callout to the first barcode.
- inverter Serial Number**: Callout to the text 'P/N: P/P/P/P/P/P/P/P/P/P'.
- Week/Year of manufacture**: Callout to the text 'SN: YYWWSSSSSS WK: WWYY'.

Additional text on the label includes: 'WO: XXXXXXXX', 'SO: SXXXXXXXXX Q1', and 'SN: YYWWSSSSSS WK: WWYY'.



The officially required information is located on the regulatory label. The identification label is an accessory label which shows the information necessary for the identification and characterisation of the inverter by FIMER. In case you need to communicate with FIMER about the inverter, the information from identification label are mandatory.



The labels are NOT to be hidden by foreign objects and parts (rags, boxes, equipment, etc.); they must be regularly cleaned and always kept in sight.

An additional Communication Identification label is applied on the wiring box 02. The label displays the following information:

The diagram shows a rectangular label divided into two parts by a dashed line. The top part contains:

- SN WLAN: SSSSSSSSSS**
- PN WLAN: VKA.V2P53.1**
- Mac Address: AA:BB:CC:DD:EE:FF**
- QR code

The bottom part contains:

- SN WLAN: SSSSSSSSSS**
- SN Wiring Box: ZZZZZZZZZZ**
- MAC: AA:BB:CC:DD:EE:FF**
- PK: 0000 - 0000 - 0000 - 0000**
- QR code

Callouts point to:

- WLAN board Serial Number**: points to SN WLAN in the top part.
- WLAN board Part Number**: points to PN WLAN in the top part.
- MAC address:**
  - To be used to obtain the SSID of the wireless access point created by the inverter: **ABB-XX-XX-XX-XX-XX-XX** (where "X" is a hex digit of the MAC address).
  - To be used to obtain the "Host Name": **http://ABB-XX-XX-XX-XX-XX-XX.local** (where "X" is a hex digit of the MAC address).
  - MAC address it's the only required information to register the inverter with Aurora Vision.
- Inverter Serial Number**: points to SN WLAN in the bottom part.
- Product Key:**
  - To be used as wireless access point password, or to be used to access to the Web UI as username and password in case of lost credentials, and to commission inverter using FIMER Installer for Solar Inverters.

Additional text on the label includes: 'Remove and apply on the plant documentation' and 'To be used to commission inverter using FIMER Installer for Solar Inverters for claiming process.'



The Communication Identification label is divided in two separate parts by a dashed line; take the bottom part and apply it on the plant documentation. (FIMER recommend to create a plant map and apply the Communication Identification label on it).

## Component reference designators

- |   |                                      |  |
|---|--------------------------------------|--|
| 01 Mounting bracket                     | 23 Cooling section                   | 50 Interposer board                                      |
| 02 Locking brackets                     | 24 Lower support                     | 51 ALARM (multifunction relay) terminal block            |
| 03 Inverter/bracket anchor points       | 30 Communication and control board   | 52 AUX (multifunction relay) terminal block              |
| 04 Wiring box front door                | 31 RSD board for (-R) version        | 53 RS485-1/RS485-2 lines, R1ON/OFF and 5V terminal block |
| 05 LED panel                            | 32 DC overvoltage surge arresters    | 54 RS485-1 120ohm termination switch                     |
| 08 Keylock                              | 33 3/4 wires selection switch        | 55 RS485-1 communication card housing                    |
| 09 Lifting ring                         | 34 Negative (-) side string fuses    | 56 RS485-1 RJ45 connector                                |
| 10 WI-FI antenna connector              | 35 Positive (+) side string fuses    | 57 RS485-2 RJ45 connector                                |
| 11 Locking brackets attachment point    | 36 AC overvoltage surge arresters    | 58 RS485-2 120ohm termination switch                     |
| 12 Ethernet cable gland                 | 37 Protective earth connection point | 59 RS485-2 communication card housing                    |
| 13 Service cable gland (PG21)           | 38 AC output screw terminal block    | 60 RS485-Main terminal block (J5)                        |
| 14 Handle                               | 39 DC input screw terminal block     | 61 Battery housing                                       |
| 15 DC disconnect switch                 | 40 AC filter board                   | 62 SD card housing                                       |
| 16 EGC connection point                 | 41 Parallel MPPT connection points   | 63 RSD board (only -R version)                           |
| 17 DC opening for Trade 2" Size conduit | 42 Fuse holder CH1                   | 64 Inverter data memory card housing                     |
| 18 AC opening for Trade 2" Size conduit | 43 Fuse holder CH2                   | 65 Ethernet connector                                    |
| 19 Input quick fit connectors CH1       | 44 Fuse holder CH3                   |  |
| 20 Input quick fit connectors CH2       | 45 Plastic protection                |  |
| 21 Input quick fit connectors CH3       | 46 Service cable gland (PG16)        |  |
| 22 Anti-condensation valve              | 47 AFD reset button                  |  |

## Inverter (external view)

- |                                     |   |
|-------------------------------------|---|
| 01 Mounting braket                  | 14 Handle                               |
| 02 Locking brackets                 | 15 DC disconnect switch                 |
| 03 Inverter/bracket anchor points   | 16 EGC connection point                 |
| 04 Wiring box front door            | 17 DC opening for Trade 2" Size conduit |
| 05 LED panel                        | 18 AC opening for Trade 2" Size conduit |
| 08 Keylock                          | 19 Input quick fit connector CH1        |
| 09 Lifting ring                     | 20 Input quick fit connector CH2        |
| 10 Wi-Fi antenna connector          | 21 Input quick fit connector CH3        |
| 11 Locking brakets attachment point | 22 Anti-condensation valve              |
| 12 Ethernet cable gland             | 23 Cooling section                      |
| 13 Service cable gland ( PG21)      | 24 Lower support                        |

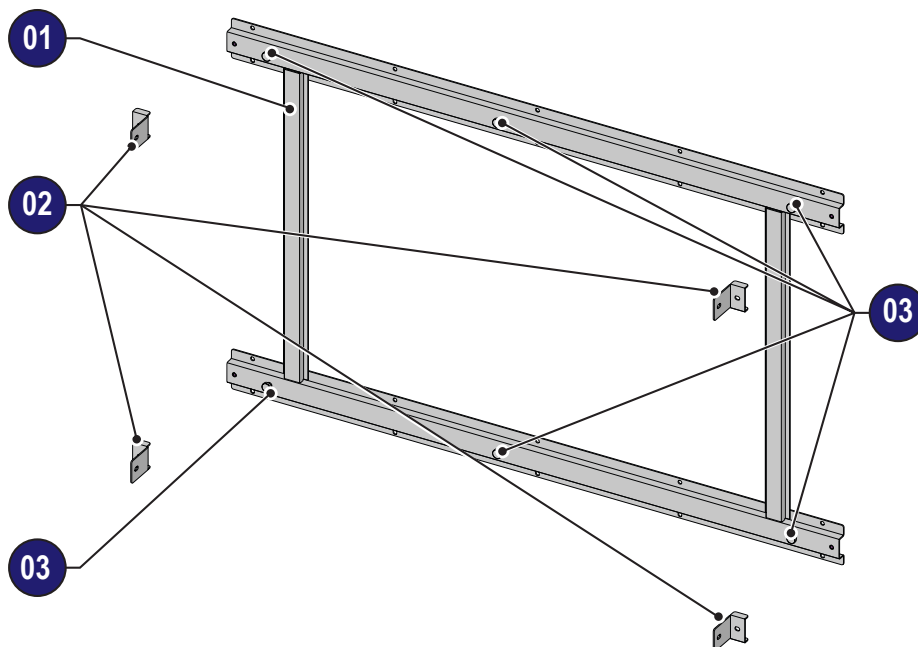

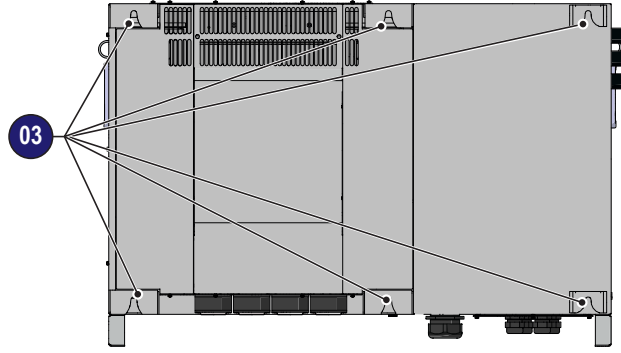
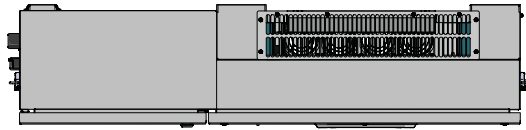

PVS-60-TL-S(-R)-US  
PVS-60-TL-SC(-R)-US

PVS-60-TL(-R)-US

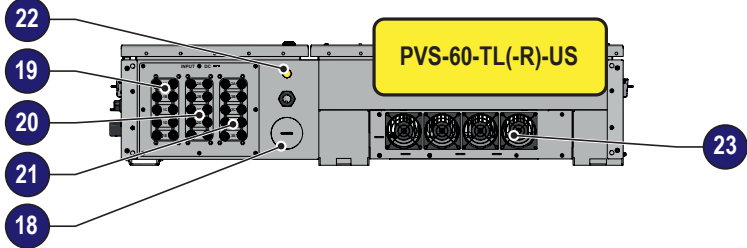
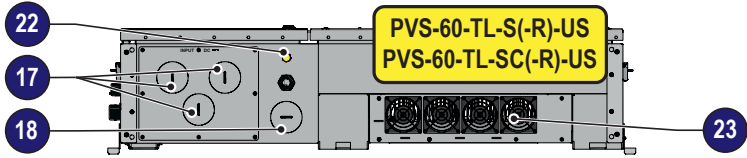
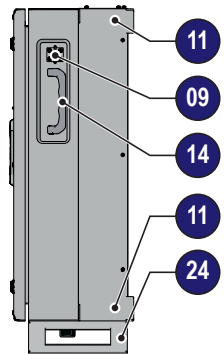
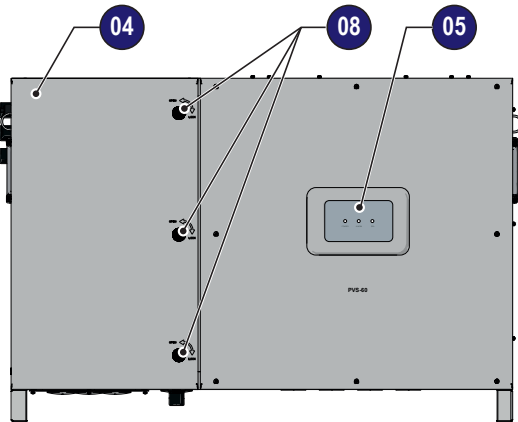
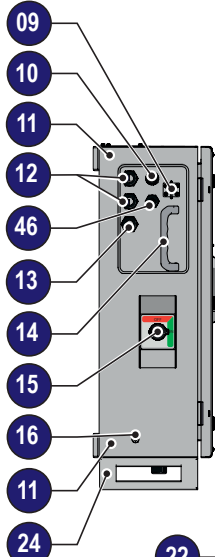
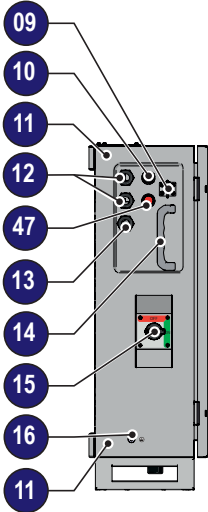



**Inverter (internal view)**

- 15 DC disconnect switch
- 30 Communication and control board
- 31 RSD board for (-R) version
- 32 DC overvoltage surge arresters
- 34 Negative (-) side string fuses
- 35 Positive (+) side string fuses
- 37 Protective earth connection point
- 38 AC output screw terminal block
- 39 DC input screw terminal block
- 41 Parallel MPPT connection points
- 42 Fuse holder CH1
- 43 Fuse holder CH2
- 44 Fuse holder CH3
- 45 Plastic protection

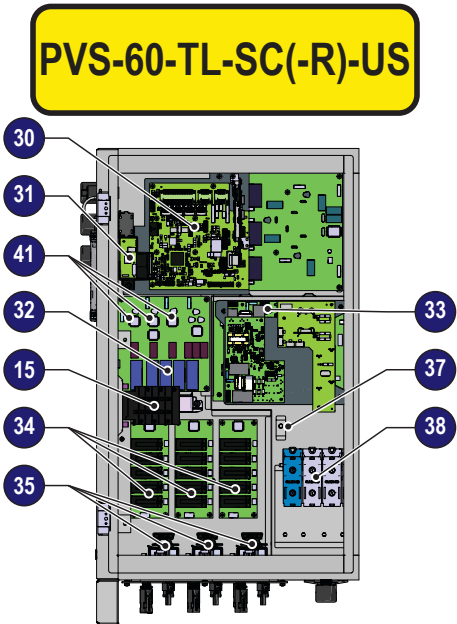
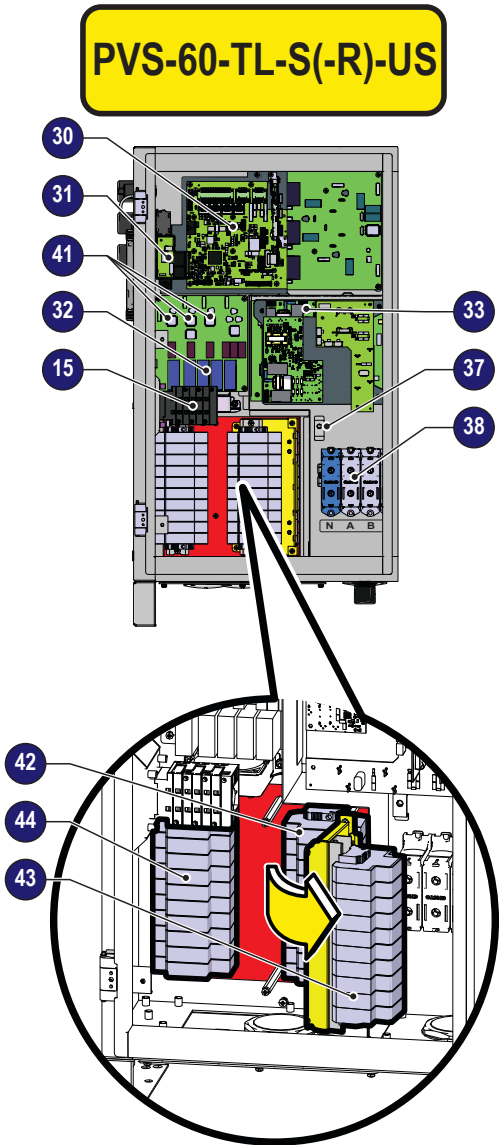
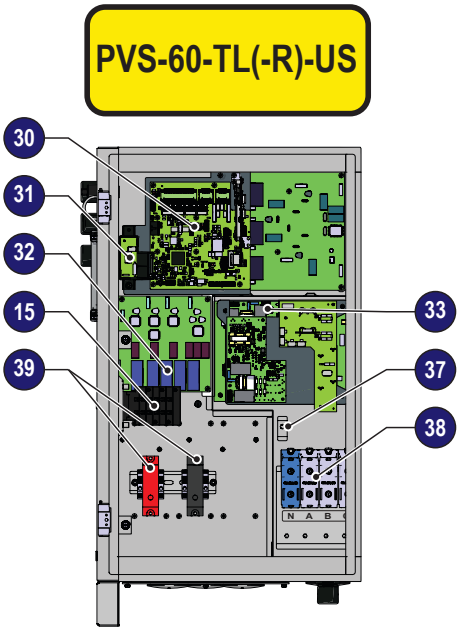

001042AG-F

## Communication board

- |  |                                       |                                   |
|--|---------------------------------------|-----------------------------------|
| 50 Interposer board  | 55 RS485-1 communication card housing | 61 Battery housing                |
| 51 ALAM (multifunction relay) terminal block               | 56 RS485-1 RJ45 connector             | 62 SD card housing                |
| 52 AUX (multifunction relay) terminal block                | 57 RS485-2 RJ45 connector             | 63 RSD board (only -R version)    |
| 53 RS485-1 / RS485-2 lines, R1ON/OFF and 5V terminal block | 58 RS485-2 120ohm termination switch  | 64 Inverter data mem.card housing |
| 54 RS485-1 120ohm termination switch                       | 59 RS485-2 comm card housing          | 65 Ethernet connector             |
|  | 60 RS485-Main terminal block (J5)     |                                   |

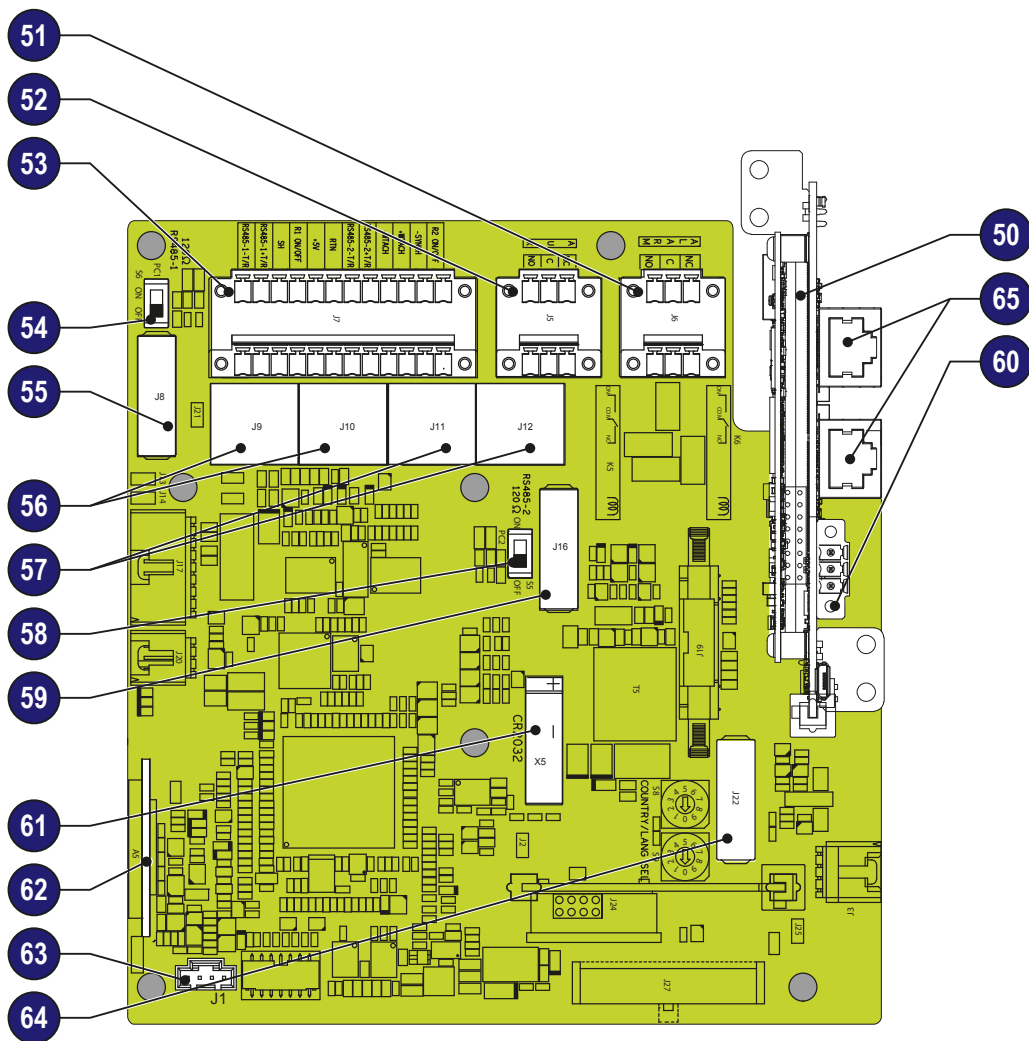

## Principal inverter components

- **DC disconnect switch** 15

**PVS-60-TL(-R)-US all versions**

Model: OTDC180U22 or equivalent

DC disconnect switch		
Voltage	Utilization category	Current
1000Vdc	DC-21B	150A (50A for each pole)

- **String fuses** 34 35

**PVS-60-TL(-R)-US -S/-SC version**

The standard string protection fuses installed on the inverter have the following features:

Voltage	Rating	Type
1000Vdc	15 A (Max. Rating 20A)	gPV

- **DC overvoltage surge arresters** 32 class 2

**PVS-60-TL(-R)-US all versions**

The DC overvoltage surge arresters installed on these inverter models are:

Brand:PTG

Model: PV600-40M2-M(5 elements)

These components are not replaceable

- **AC overvoltage surge arresters** 36 class 2

**PVS-60-TL(-R)-US all versions**

The AC overvoltage surge arresters installed on these inverter models are:

Brand:PTG

Model: PTE 385-40M2-10 (4 elements)

These components are not replaceable

## Characteristics and technical data

Table: Technical Data		PVS-60-TL-US
<b>Input</b>		
Absolute maximum input voltage (V <sub>max,abs</sub> )	1000 Vdc	
Input start-up voltage (V <sub>start</sub> )	420...700 V (Default 500V)	
Input operating interval (V <sub>dcmín</sub> ...V <sub>dcmáx</sub> )	0.7x V <sub>start</sub> ... 950 V (min 360V)	
Rated input voltage (V <sub>dcr</sub> )	720 Vdc	
Input nominal power(P <sub>dcr</sub> )	61800 W	
Number of independent MPPT	3 (S and SC version)/ 1 (standard version)	
Maximum DC input power for each MPPT (P <sub>MPPT,max</sub> )	21000W@45°C	
MPPT DC voltage range (V <sub>MPPTmin</sub> ... V <sub>MPPTmax</sub> ) to P <sub>acr</sub>	570-800 Vdc	
Maximum DC input current for each MPPT (I <sub>dcmáx</sub> )	36 A	
Maximum short circuit current for each MPPT (I <sub>scmáx</sub> )	55 A (165A in case of parallel MPPT)	
Number of DC input pairs for each MPPT	5 (S and SC version)	
Type of input DC connectors	Screw terminal block, conduit entry (standard version) fuse holder, conduit entry (-S version) PV quick fit connector (-SC version)	
<b>Input protection</b>		
Reverse polarity protection	Yes, from current limited source	
Input over voltage protection for each MPPT -	Yes, type 2	
Photovoltaic array isolation control	according to US standard	
Residual current monitoring device	Yes, according to IEC 62109-2	
DC switch rating for each MPPT(version with DC switch)	75A/1000V for each MPPT (180A in case of parallel MPPT)	
Fuse rating ( version with fuses)	15A /1000 V	
Arc fault protection	Yes (S and SC version)	
<b>Output</b>		
AC Connection to the grid	Three phase (3W+PE or 4W+PE),grounding WYE system only	
Rated AC Output Power (P <sub>acr</sub> @cosφ=1)	60000 W	
Maximum apparent Output power (S <sub>max</sub> )	60000 VA	
Rated AC Output Voltage (V <sub>acr</sub> )	480 V	
Output voltage range (V <sub>acmín</sub> ...V <sub>acmáx</sub> )	384...571 V <sup>(1)</sup>	
Maximum output current (I <sub>acmáx</sub> )	77 A	
Contribution to short-circuit current	92 A	
Rated Output Frequency (f <sub>r</sub> )	60 Hz	
Output Frequency Range (f <sub>mín</sub> ...f <sub>máx</sub> )	50...64 Hz <sup>(1)</sup>	
Nominal power factor and setting interval	> 0.995, 0...1 inductive/capacitive with maximum S <sub>max</sub>	
Total harmonic distortion of current	<3%	
Maximum AC Cable	AWG 3/0 copper/aluminum	
AC Connection type	Screw terminal block, conduit entry	
<b>Output protection</b>		
Anti-islanding Protection	According to US standard	
Maximum external AC overcurrent protection	100 A	
Output overvoltage protection surge arrester	Yes, Type 2	
<b>Operating performance</b>		
Maximum Efficiency (η <sub>max</sub> )	98.5%	
Weighted Efficiency (EURO/CEC)	98.0% / 98.0%	

<b>Table: Technical Data</b>		<b>PVS-60-TL-US</b>
<b>Communication</b>		
Embedded communication interfaces	3x RS485, 2x Ethernet (RJ45), WLAN (IEEE802.11 b/g/n @ 2,4 GHz)	
User Interface	3 LEDs, Web User Interface, Mobile APP	
Communication protocol	Modbus RTU/TCP (Sunspec compliant)	
Commissioning tool	Web User Interface, Mobile APP	
Remote monitoring services	Aurora Vision® cloud platform	
Advanced features	Built-in Export Limitation control algorithm, Integrated data logger, direct connection of supported accessories, Multi-inverter plant commissioning by mobile app, lifetime free-of-charge standard access to Aurora Vision cloud services Remote FW update	
<b>Environmental</b>		
Ambient temperature range	-25...+60°C / -13...140°F with derating above 45°C / 113 °F	
Storage temperature	-25°C..+60°C / -13°F..+140°F with derating over 45°C (113°F)	
Relative Humidity	4...100 % with condensation	
Typical noise emission pressure	75 dB(A) @ 1 m	
Maximum operating altitude without derating	4000 m / 13123 ft with derating above 2000 m/6561 ft	
<b>Physical</b>		
Environmental Protection Rating	NEMA 4X(NEMA 3R for fan tray)	
Cooling System	Forced air	
Dimensions (H x W x D)	750x1100x261.5 mm / 29.5"x43.3"x10.27"	
Weight	~71 kg / 156.52 lbs (SC version)	
Assembly System	Wall Mounting bracket ( vertical o horizontal)	
<b>Safety</b>		
Insulation Level	Transformerless	
Marking	TUV	
Safety, EMC and Radio Spectrum Standards	UL 1741,Rule 21,HECO tester per UL 1741 SA,UL 1699B, UL 62109-1:2014, UL 50E(type 4x), IEEE1547,IEEE1547.1,CSA C22.2 107.1-01-2001,CSA TIL M-07,FCC Part 15 Sub-part B class B Limited	
<b>Accessories</b>		
DC Series Arc Fault Circuit Interrupter	Type I acc. to UL 1699B <sup>(2)</sup> with single-MPPT sensing capability	

1. The AC voltage and frequency range may vary depending on specific country grid standard
2. Performance in line with the relevant requirements of the Draft IEC 63027 standard

**Note. Features not specifically mentioned in this data sheet are not included in the product**

## Tightening torques

To maintain the NEMA 4X protection rating of the system and for correct installation, the following torques must be used:

Component	N-m	ft-lb
DC input terminal block <sup>39</sup> 4 AWG-3/0 AWG (standard model)	20 N-m	14.7 ft-lb
DC fuse holder 12 AWG-3/0 AWG (-s model)	20 N-m	14.7 ft-lb
AC output terminal block 4 AWG -3/0 AWG	14 N-m	10.3 ft-lb
Signal terminal block (26...15AWG)	0.25 N-m	0.18 ft-lb
Service cable gland (PG21 size) <sup>13</sup>	7.5 N-m	5.53 ft-lb
Service cable gland (PG16 size) <sup>46</sup> ( standard model)	5.0 N-m	3.7 ft-lb
Ethernet cable gland (PG21 size) <sup>12</sup>	7.5 N-m	5.53 ft-lb

## Cable gland clamping range and conduit openings diameter

Component	mm	Inch
DC opening for Trade 2" Size conduit <sup>17</sup> (standard and -S models)	61mm	2.4"
Service cable gland (PG21 size) <sup>13</sup>	13...18mm	0.51...0.7"
Service cable gland (PG16 size) <sup>46</sup> (standard model)	10...14mm	0.39...0.55"
Ethernet cable gland (PG21 size) <sup>12</sup>	13...18mm	0.51...0.7"
AC opening for Trade 2" Size conduit <sup>18</sup>	61mm	2.4"

### Overall dimensions

The overall dimensions (not including the mounting bracket 01) are expressed in millimetres and inches.

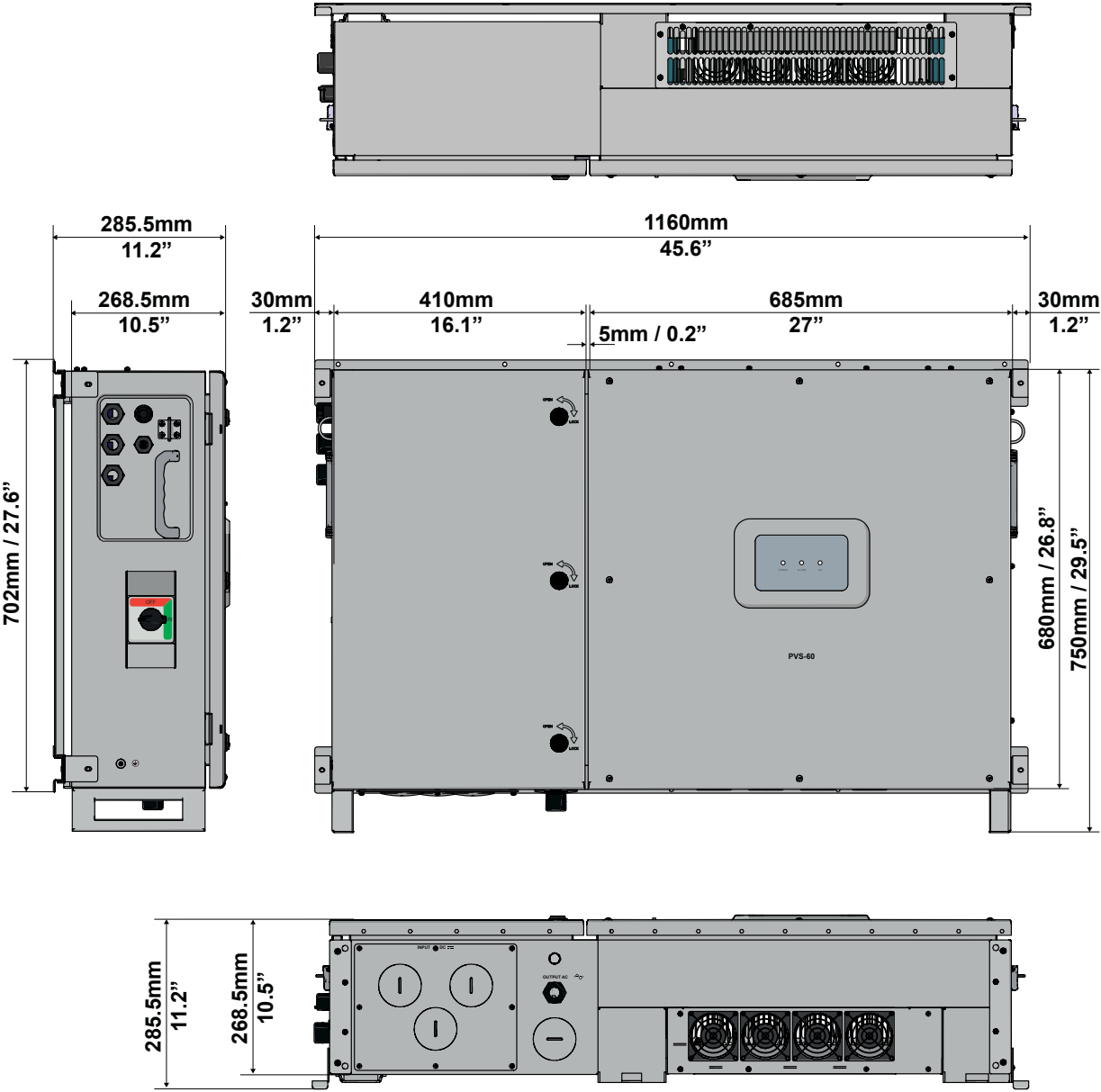

## Mounting bracket

The dimensions of the wall mounting bracket **01** are expressed in millimetres and inches. The diameter of holes in the bracket are 9mm/0.35".

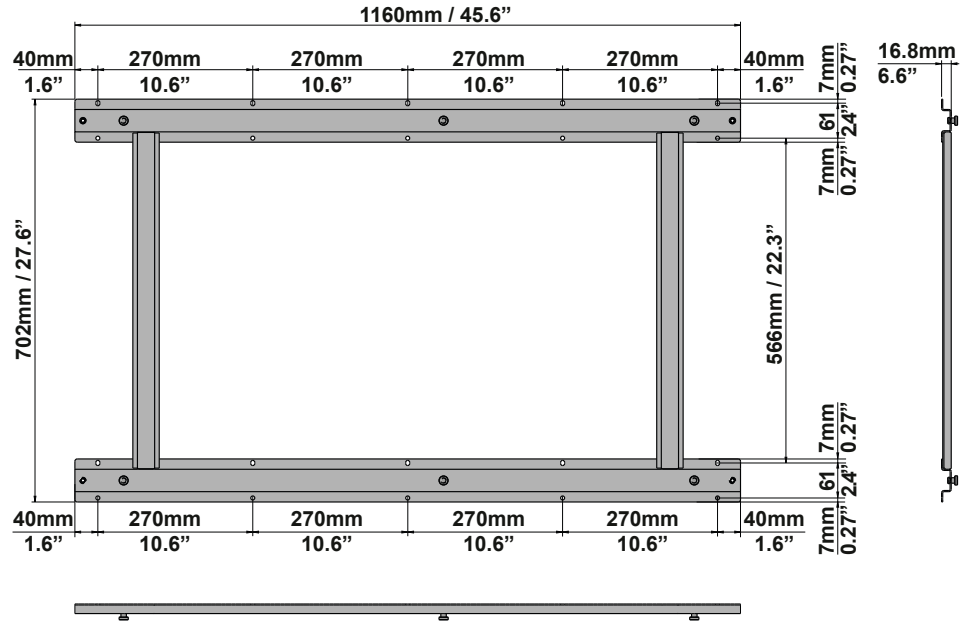



# Efficiency curves

Graphs of the inverter efficiency for various input voltages are below:

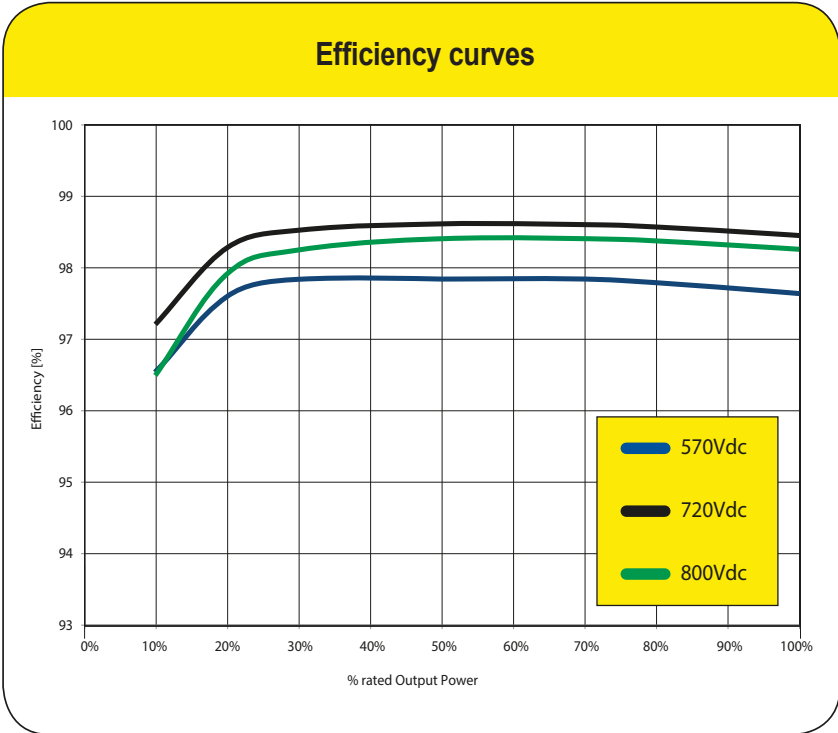

The efficiency curves are approximate.

## Automatic power limiting (Power Derating)

When needed, the inverter automatically reduces the power fed to the grid.

Power limiting may occur due to the following

- Installation site ambient temperature is too hot (thermal derating)
- Output power percentage set by user
- Grid overfrequency (set by user)
- Grid overvoltage  $U > 10\text{min}$  (enabled by user)
- Anti-islanding
- Grid undervoltage
- Input voltage too high
- Input current too high.
- Cease-to-energize region of California Rule 21 reached.
- Volt-Var grid support functionality.
- Volt-Watt grid support functionality.

### Power derating due to environmental conditions

The power reduction value and the inverter temperature at which it occurs depend on the ambient temperature and on many operating parameters. Example: input voltage, grid voltage and power available from the photovoltaic field.

The inverter can therefore reduce the power during certain periods of the day according to the value of these parameters.

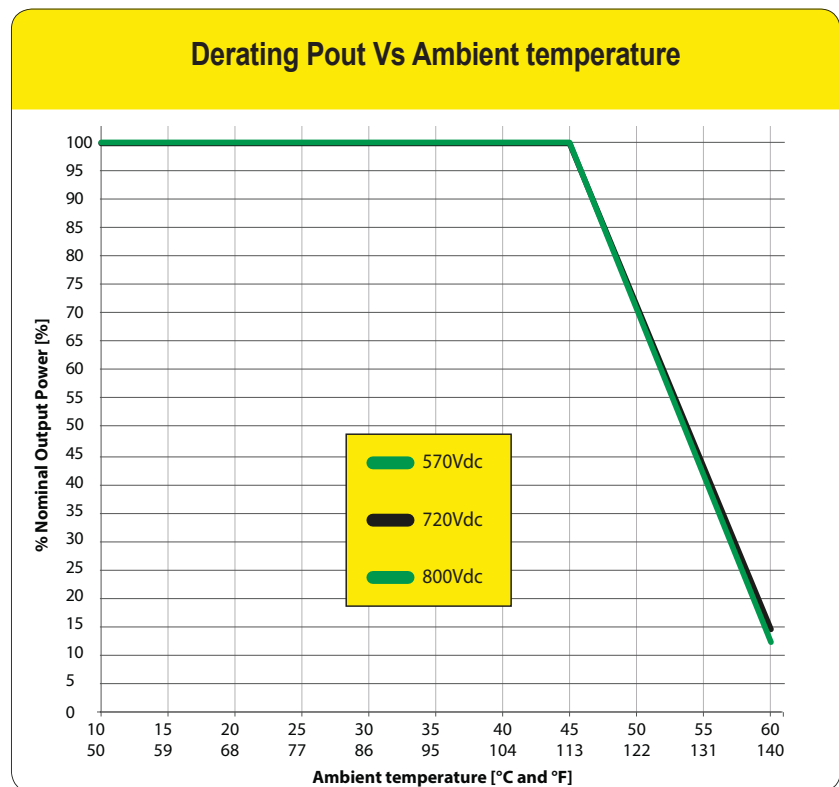

### Power reduction due to the input voltage

The reduction of the power supplied where the DC input voltage values are too high or too low is adjusted automatically.

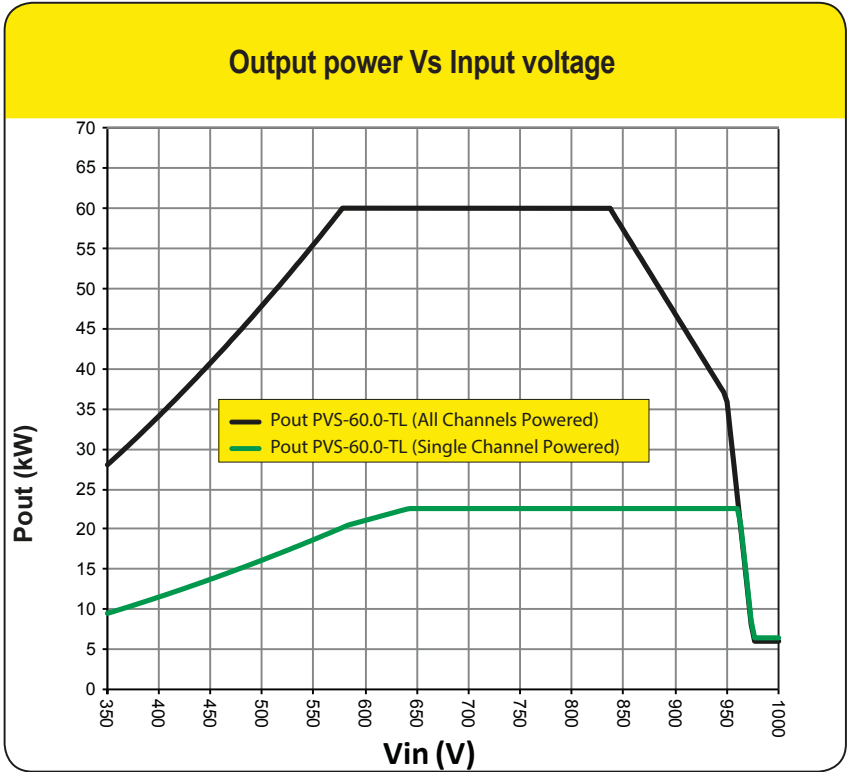

\* The curves on the graph, indicate how “All input powered”, are valid if the input voltages (of each input channel) are balanced.

\* The curves on the graph are valid with nominal value of grid voltage.

### Power reduction due to the grid voltage

The reduction of the power supplied where the grid voltage values are too high or too low is adjusted automatically.

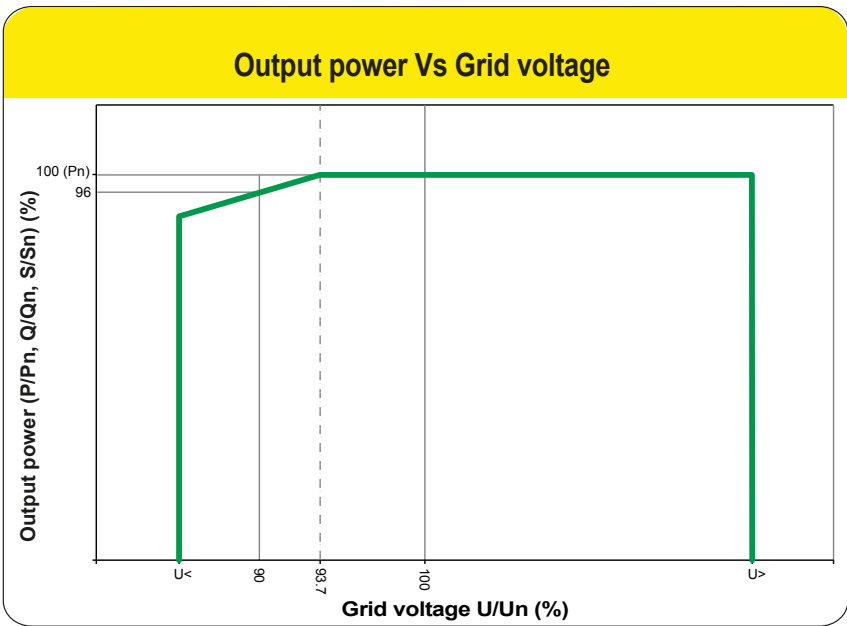

The U< and U> values could change based on the grid country standard selection

## P- Q curve capability

Based on the country grid standard the P-Q capability curve can be reduced.

### PVS-60-TL

- Rated output voltage ( $U_n$ ) 480Vac
- Rated active power ( $P_n$ ) 60kW
- Nominal apparent power ( $S_n$ ) 60kVA
- Rated reactive power ( $Q_n$ ) 60kVAR
- Cos -0 ... 1 ... 0 +
- 100%  $P_n$  Capability with grid voltage between  $0.937 \times U_n$  ...  $1.2 \times U_n$

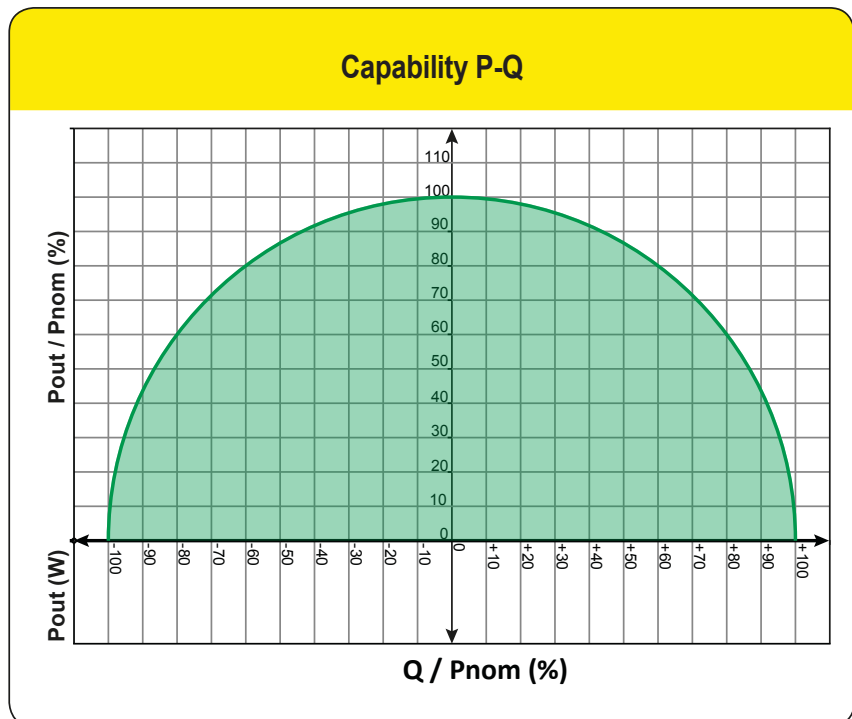

## Characteristics of a photovoltaic generator

A PV electric system consists of an assembly of photovoltaic modules that transform solar radiation into DC electrical energy and can be made up of:

**Strings:** number of PV modules connected in series

**Array:** group of strings connected in parallel

### Strings and arrays

The string technology was developed to significantly reduce the installation costs of a photovoltaic system, mainly associated to wiring on the DC side of the inverter and subsequent distribution on the AC side. A photovoltaic module consists of many photovoltaic cells mounted on the same support.

- A string consists of a certain number of module connected in series.
- An array consists of two or more strings connected in parallel.

Large photovoltaic systems can include multiple arrays connected to one or more inverters.

The greater the number of panels in each string, the lower the cost and the less complex the wiring connections of the system.

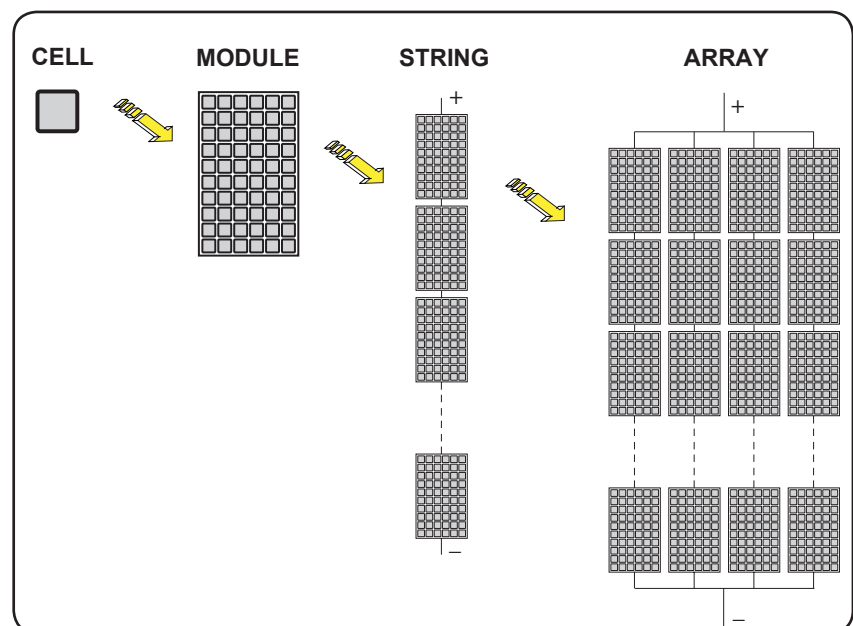

## Description of the equipment

This equipment is a string inverter which converts the direct current of a photovoltaic generator into alternating current and feeds it into the public distribution grid.

Photovoltaic panels convert solar radiation into “DC” electrical energy (via a photovoltaic field, also called PV generator); in order to use it, it is transformed into “AC” alternate current. This conversion, known as inversion from DC to AC, is done in an efficient way by the FIMER inverters, without using any rotary elements, rather only via static electronic systems.

In order to allow inverter operation in safe thermal and electrical conditions, the unit automatically reduces the value of the power fed into the grid under adverse environmental conditions or unsuitable input voltage values.

When connected in parallel with the grid, the alternating current from the inverter flows directly into the domestic or industrial distribution circuit, which is in turn connected to the public distribution grid.

This way the solar energy system compensates for the energy drawn from the utilities connected to the grid to which it is linked.

When the photovoltaic system is not generating sufficient energy, the power required to ensure proper operation of connected loads is taken from the public distribution grid. While if too much energy is produced, it is directly fed to the grid, thus becoming available to other users.

According to national and local standards and regulations the produced energy can be sold to the grid or credited to the user against future consumption, thus granting a great saving of money.

### Operating diagram (example)

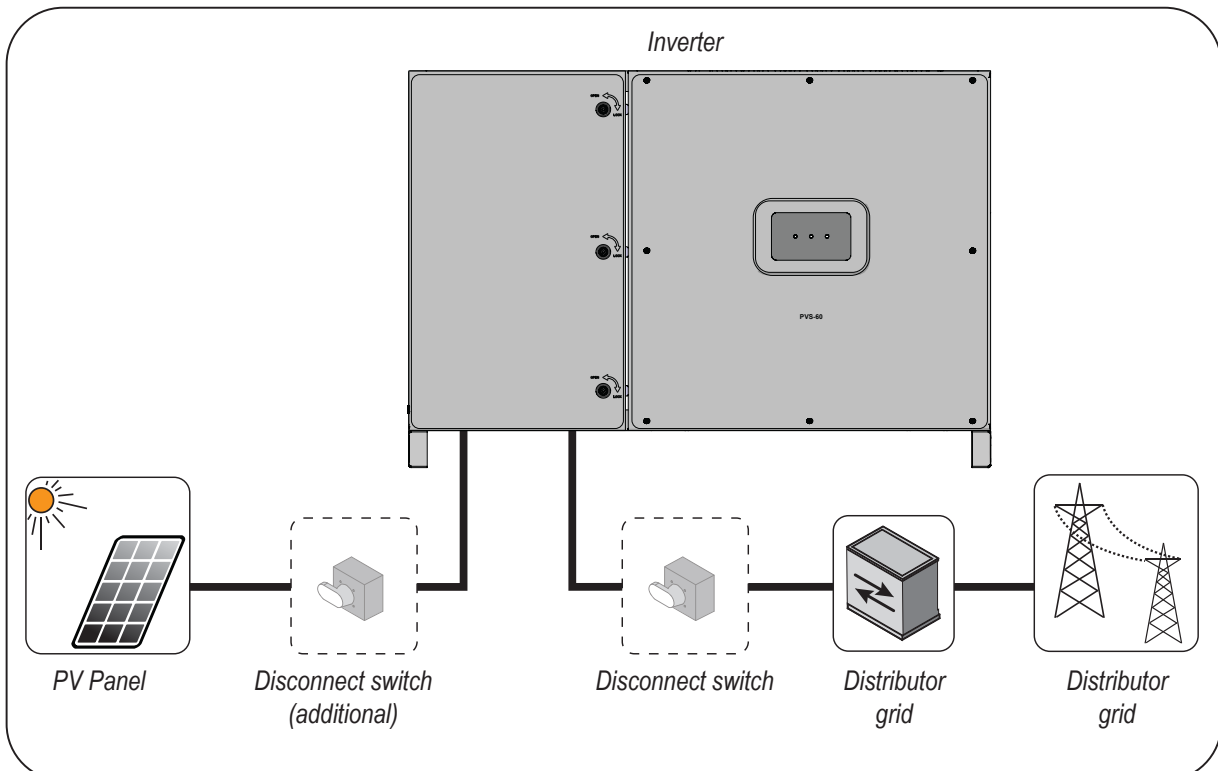

## Mutual connection of multiple inverters

If the photovoltaic system exceeds the capacity of a single inverter, it is possible to connect multiple inverters to the system, each of them in turn connected on the DC side to a separate section of the photovoltaic generator, and on the AC side to the distribution grid.

Each string inverter will work independently of the others and its own photovoltaic module will supply the maximum power available to the grid.

## Notes on the system sizing

*Decisions on how to structure a photovoltaic system depend on a series of factors and considerations, such as the type of panels, the space availability, the future location of the system, energy production goals over the long term, etc.*

A configuration program that can help to correctly size the photovoltaic system is available on the FIMER website (<http://stringsizer.fimer.com>).

## Functionality and components of the equipment

### Highlights

- 3 independent MPPT ( only for S and SC versions)
- Transformerless inverter
- Double stage topology for a wide input range
- Large set of specific grid codes available which can be selected directly in the field
- Both vertical and horizontal installation
- Wireless access to embedded user interfaces
- FIMER Installer for Solar Inverters APP for commissioning of inverters
- Ethernet daisy chain enabled (supports both ethernet star/ring topology)
- One RS485 line acting as master or slave
- Modbus TPC/RTU Sunspec compliant
- Remote monitoring and firmware update via Aurora Vision® (logger free)
- Equipped with rapid shut down board for external panel level devices (-R models)

### Improved commissioning and maintenance

#### **FIMER Installer for Solar Inverters APP**

Improved multi inverter installation with FIMER Installer for Solar Inverters APP by using Android mobile devices (the app for iOS mobile devices will be implemented soon).

#### **Integrated Web User Interface**

The inverter is equipped with an ethernet and wireless (IEEE802.11 b/g/n) board and with an Integrated Web User Interface that allow a full access to all main configuration and parameters of the inverter. It can be accessed by using from any ethernet or wireless capable device like laptop, tablet or smartphone via a common internet browser.

#### **Remote firmware update function**

The inverter firmware can be updated remotely using the Integrated Web User Interface dedicated section or via Aurora Vision® or via FIMER Installer for Solar Inverters APP.



## Aurora Vision Plant Management Platform

Integrated logging capability allows remote monitoring of the plant without the need of any additional external loggers.

Aurora Vision is a cloud based platform enabling remote monitoring and asset management of FIMER devices in range of solar power application.

Aurora Vision consists of three different products:

1. **Plant Portfolio Manager** is a full featured web based application used by solar power professionals to monitor and manage a portfolio of solar power plants using FIMER inverters.
2. **Plant Viewer** is an easy to use web based serviced application used by non-solar power professionals (such as homeowners or small business owners) to monitor solar power plants they own.
3. **Plant Viewer for Mobile** is the mobile version of **Plant Viewer** enabling non-solar power professionals to remotely monitor their own PV plants by using smart phones, tablets and iPod Touch with IOS and Android operating systems.

All three product previously mentioned work together to allow solar power professional and site owners to collaboratively manage solar power plants.

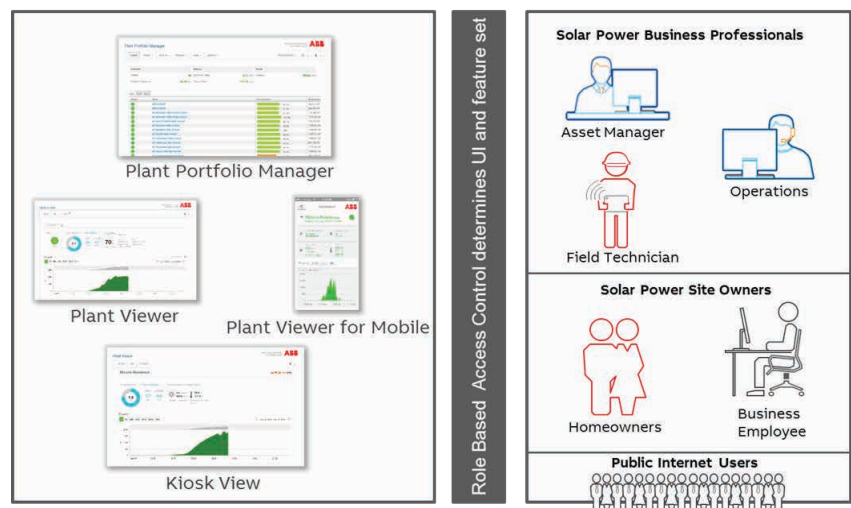

*Please contact the FIMER technical support for getting your own plant portfolio manager account (mainly for installers and plant administrators). Please get your Plant Viewer and Plant Viewer for Mobile by accessing the website [www.auroravision.net](http://www.auroravision.net) and click on "Register with Plant Viewer" button (mainly for site owners).*

### Configurable relays

The inverter is equipped with two configurable switching relays, which can be used in different operating configurations that can be set using the web user interface. A typical example of application is closing the contact when an alarm is triggered.

### Remote switch-on/switch-off

This command can be used to switch off/switch on the inverter via an external (remote) command using the Remote ON/OFF terminal block. This functionality must be enabled in the web user interface and when active, switching on the inverter, besides being dictated by the presence of normal parameters which allow the inverter to be connected to the grid, also depends on the external control for switching on/off.

### Reactive power feed into the grid

The inverter is able to produce reactive power and can feed this power into the grid via the power factor setting. Power feeding modes vary according to the country or state/province of installation and the grid companies.

### Limiting the active power fed into the grid

The inverter can limit the amount of active power fed into the grid by the inverter to the desired and adjustable value.

### Overvoltage surge arrester monitoring

The inverter monitors the status of the overvoltage surge arresters, and generates a warning in the event of a fault (viewable via monitoring system, internal web user interface or Installer Mobile APP).

### RSD board (only -R models) \*

Rapid shut down (RSD) board allows fast discharge of positive and negative input voltages to ground: when used in conjunction with a device able to discharge differential input voltage, the whole system is compliant with NEC 2017 690.12 RSD requirements. Since RSD is a safety-related feature, RSD board self-test is repeated every 24 hours during inverter initialization phase: self-test fails if RSD functionality is damaged, resulting in alarm E103.

\* Must be installed and operated in conjunction with external panel level rapid shut down devices (please refer to local sales representative for a list of compatible devices).

### Data transmission and control

Embedded multi communication interfaces (WLAN, Ethernet, RS485) combined with a Sunspec compliant Modbus protocol (RTU/TCP) allow the inverter to be easily integrated with any third party monitoring and-control systems that support the same Sunspec standard.



*Please contact the FIMER technical support or get access to Sunspec alliance website for further information on Modbus Sunspec products.*

## Communication connection diagrams

The communication connection diagrams shows how the integrated ethernet and wireless board allows the local or remote connection to the inverter.

### Communication interface

The inverter provide the following integrated communication interfaces:

**- WLAN channel (IEEE 802.11 b/g/n@2.4GHz)**

The use is recommended to access wirelessly to embedded web server by using any WLAN standard device (PC, tablet, smartphone) for commissioning and parameter setting. Additionally there is second radio channel that can be used for connection to wireless router.

**- 2x Ethernet ports (10/100BaseTx - RJ45 plugs)**

The ports are configured by default for enabling daisy chain connection of the inverters over the Ethernet bus.

In order to improve the reliability of the communication with the inverters it is also allowed to create ring shape layout by using this Ethernet bus.

**- 3x RS485 ports (terminal block)**

The ports enables daisy chain connection of the inverters over the serial line (slave mode). The ports can either be used for connecting supported accessories (like weather station, meter...): in this case data from accessories will be logged and transferred to the cloud by inverter itself (master mode).

### Ethernet bus connection

By default the 2 Ethernet ports of the inverters are already configured for enabling communication over daisy chain layout.

Once physically connected the inverters does not need specific settings: after the first turning on, the inverters automatically got all needed network parameters with or without the presence of DHCP server. If an internet connection is available on site the inverters are automatically configured to transmit telemetry data to Aurora Vision Cloud without the need of installing any additional device (logging capability are already integrated into the inverter by default).



*Aurora Vision Plant Management platform is the FIMER cloud solution allowing customer to remotely monitor and manage its own solar plants. Please refer to <http://www.fimer.com> or contact FIMER technical support for further information on how getting an Aurora Vision account*

With the inverters connected over Ethernet daisy chain and with an available internet connection it will be always possible, via Aurora Vision Cloud, to upgrade remotely the firmware of the inverters.

In order to improve the communication services and allow reaching of

all the inverters in the chain also in presence of fault it is recommended to create a ring shape layout by connecting both the first and the last inverters of the chain to the local Ethernet switch (as shown in the picture)

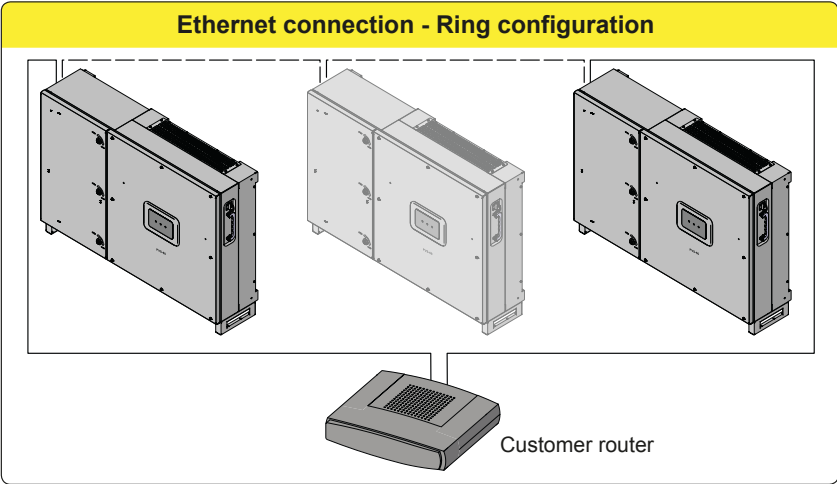

*Please refer to chapter 5 for further information about the installation.*

## Topographic diagram of the equipment

The diagram summarises the internal structure of the inverter.

The internal circuitry is with double stage conversion and therefore consists of:

- DC/DC input converter (booster)
- DC/AC output inverter

The DC-DC converter and the DC-AC inverter both work at a high switching frequency and are therefore small and relatively light related to output power.

The input converter is dedicated to multiple PV arrays with a maximum power point tracking (MPPT) function in order to maximize the energy harvesting from the photovoltaic generator.

This inverter version is of the type without transformer, that is without galvanic insulation between the input and the output. This allows ultimately an increase in conversion efficiency. The inverter is already equipped with all the protections necessary for safe operation and compliance with the norms, even without the insulation transformer.

The operation and the protection management of the inverter is controlled by two independent DSPs (Digital Signal Processors) and a central microprocessor.

A dedicate microprocessor is used for user communication interfaces.

The connection to the distribution grid is thus kept under control by two independent DSPs, in full compliance with the electric field norms both for power supply to the systems as well as security.

The operating system carries out the task of communicating with its components in order to carry out data analysis.

In doing all this, we guarantee optimal operation of the whole assembly and a high performance in all irradiation conditions and always ensuring full compliance with the relevant directives, standards and regulations.



## Safety devices

### Anti-Islanding

In the event of a local grid outage by the electricity company, or when the equipment is switched off for maintenance operations, the inverter must be physically disconnected to ensure the protection of the people working on the grid, in accordance with the relevant national laws and regulations. To prevent possible islanding, the inverter is equipped with an automatic safety disconnection system called "Anti-Islanding".

The method used to ensure an active anti-islanding protection is: active frequency drift in combination with RoCoF techniques.

*Anti-islanding protection mechanisms are different depending on the grid standards, even if they all have the same purpose.*

### Ground fault of the photovoltaic panels

Use this inverter with panels connected in "floating" mode, i.e. with no earth connections on the positive and negative terminals. An advanced ground fault protection circuit continuously monitors the ground connection and disconnects the inverter when a ground fault indicating the fault condition by means of the red "GFI" LED on the LED panel on the front side of wiring box.

### String fuses

The DC compartment can be equipped with string fuses are:

-S version - Negative side (-) string fuses <sup>34</sup> and the positive side (+) string fuses <sup>35</sup> are preinstalled.

-SC version - Negative side (-) string fuses <sup>34</sup> and the positive side (+) string fuses <sup>35</sup> are preinstalled.

The fuses protect the appliance from currents exceeding the limit value independently for each string.

*The sizing of the fuses must therefore be carefully assessed during installation.*

### Overvoltage surge arresters

As an additional protection to prevent damage caused by the discharges from lightning and electrostatic induction phenomena, the wiring box is equipped with DC overvoltage surge arresters <sup>32</sup> and with AC overvoltage surge arresters <sup>36</sup>.

### Other safeguards

The inverter is equipped with additional protective devices to ensure safe operation in any circumstance. These protections include:

- Constant monitoring of the grid voltage to ensure that voltage and frequency values remain within operating limits;
- Internal temperature control to automatically limit the power if necessary to prevent overheating of the unit (derating).

*The numerous control systems determine a redundant structure to ensure absolutely safe operations.*

## General conditions

*Some recommendation apply only to large size product or multiple small size product packaging.*

### Transport and handling

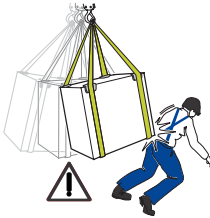

#### Lifting

Transport of the equipment, especially by road, must be carried out with means for protecting the components (in particular, the electronic components) from violent shocks, humidity, vibration, etc.

**During handling, do not make any sudden or fast movements that can create dangerous swinging.**

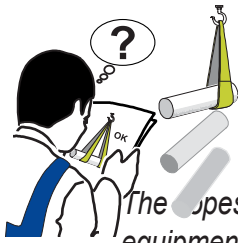

*The ropes and equipment used for lifting must be suitable for bearing the weight of the equipment.*

FIMER usually stores and protects individual components by suitable means to make their transport and subsequent handling easier, but as a rule, it is necessary to utilize the experience of specialized staff in change of loading and unloading the components.

Do not lift several units or parts of the equipment at the same time, unless otherwise indicated.

### Unpacking and checking

Packaging elements (cardboard, cellophane, staples, adhesive tape, straps, etc.) may cause cuts and/or injuries if not handled with care. They should be removed with the proper equipment.

*The components of the packaging must be disposed on in accordance with the regulations in force in the country of installation.*

When you open an equipment package, check that the equipment is undamaged and make sure all the components are present.

If you find any defects or damage, stop unpacking and consult the carrier, and also promptly inform FIMER Service.



### Storage

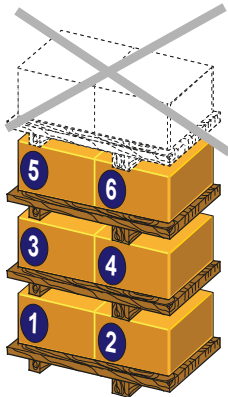

If the package is stored correctly, it can withstand a maximum load of 6 stacked devices (divided into 3 pallets).

*DO NOT stack with equipment or products other than those indicated.*

### Weight of the modules of the equipment

Table: Weights	Weight (kg)	Lifting points (n°#)
PVS-60-TL-SC-(-R)-US	71kg/156.52lbs	4 (2 handles and 2 lower support)

### Types of lifting

Because of its weight, the inverter must be lifted by two people or alternatively using suitable lifting equipment.

In order to make the inverter easier to manage, handles 14 and lower support 24 should be used to lift the inverter.





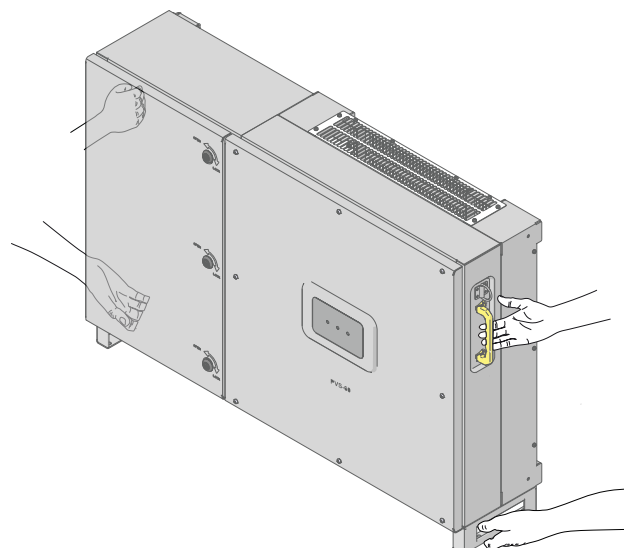

*The lateral lifting rings should be used only to pull out the inverter from the box.*

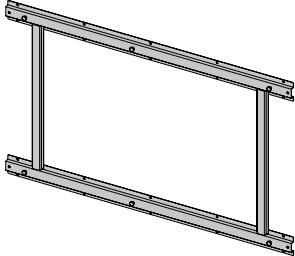
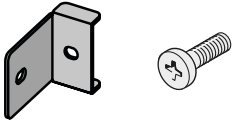
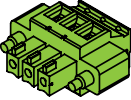
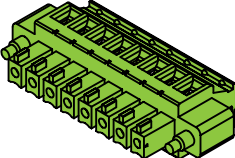
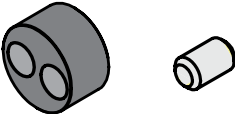
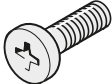

## List of components supplied

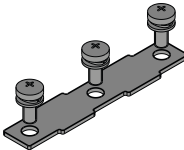
Supplied with the inverter are all the components required to correctly install and connect the inverter

Components available for all inverter models		Qty
	Mounting bracket <b>01</b>	1
	Locking brackets <b>02</b> + screws for the locking bracket mounting	4+8
	Connector for connection of the configurable relay	2
	Connector for connecting the communication and control signals	2
	Two-hole gasket for service cable glands <b>13</b> PG 21 + cap	2 + 2
	M6 screw for securing the: - Protective earth connection point <b>37</b> - EGC connection point <b>16</b>	2
	M6 toothed washer for securing the: - Protective earth connection point <b>37</b> - EGC connection point <b>16</b>	4
	Wi-Fi antenna	1
	Bar for parallel input channels configuration + M5x12 screws (equipped with cut and flat washer)	1 + 3
	Key for front door key-lock <b>08</b>	1
	Technical documentation	

## Installation warnings



*The inverter must be correctly installed, in a suitable location, to operate properly and safely.*



*Installers must know and understand applicable NEC requirements and any local codes for photovoltaic systems.*



*Installers must know and understand OSHA and other applicable safety requirements, including lockout/tagout procedures.*



*Remember that when the photovoltaic panels are exposed to sunlight they provide continuous DC voltage to the inverter. Before installation may begin, photovoltaic panels must be shaded or isolated.*



*Before installation may begin, the inverter must be disconnected from the grid (power disconnect switch open and external AC disconnect locked out/tagged out) .*



*Limit installation to licensed electricians experienced in PV plant wiring.*



*Obtain approval of the local AHJ before connecting the inverter to the electrical grid*



*The equipment owner must post the PPE level per NFPA TDE-2012, Table 13*

## Installation planning

### Sizing the ground cable(s)

FIMER inverters must be grounded at the protective earth (PE) connection point **37**  terminal.

*Size the cable(s) in accordance with NEC and any local codes.*

*The conductor must be large enough to handle the maximum ground fault current that the PV system might experience.*

*The warranty is void if the inverter isn't connected to ground through the appropriate terminals.*

Follow site wiring diagrams and grounding plans. At a minimum expect this to include:

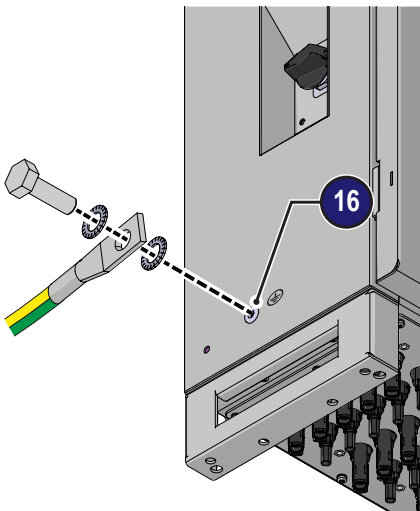

- A PV array equipment ground, to be landed in the EGC connection point **16**.

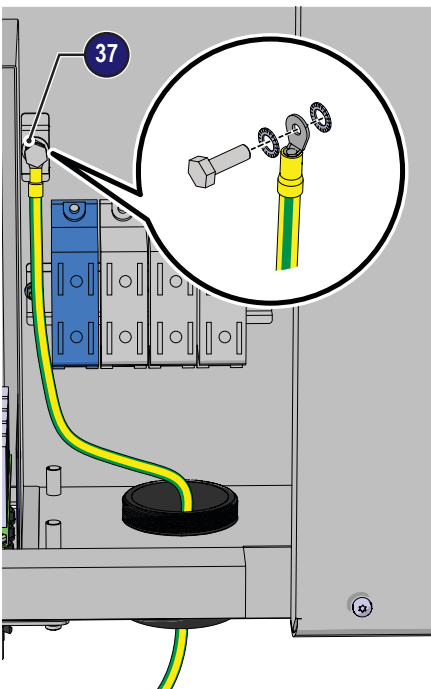

- A protective earth (PE) conductor, to be landed on the protective earth connection point **37**. The terminal accept a ring cable lug, suitable for a M6 size threaded insert (Torque to 11Nm / 8 ft-lb).

## Choice of grid output connection type (AC side)

The medium voltage transformer, i.e. the grid (distribution system), must face the inverter as a **grounded WYE**, whose Neutral may or may not be brought to the inverter:

### 1. Lines R,S,T, Neutral + GND (“four-wire”)

The DIP switch S1 <sup>33</sup> must be set for “4 WIRES” before commissioning the inverter:

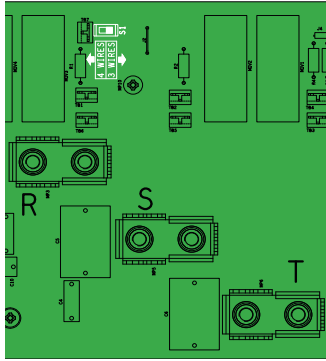

### 2. Lines R,S,T + GND (“three-wire,” and in this case, the inverter creates its own “virtual” neutral)

The DIP switch S1 <sup>33</sup> must be set for “3 WIRES” before commissioning the inverter:



**Delta connections to the grid are NOT permitted.**  
**Caution! Connect the ground before the grid connections.**

## Sizing the AC cable

The AC output conductors must be sized according to operating temperature range and continuous current ratings.

- Size conductors per NEC Article 310.
- Use 90°C wire only;
- AC output terminal block <sup>38</sup> → 4AWG to 3/0AWG copper or aluminum.

Note that undersized wiring may cause nuisance tripping (disconnection) of the inverter. Too-high wiring impedance increases the AC voltage seen at the inverter terminals. In compliance with UL1741 and IEEE1547, the inverter may need to disconnect from the grid under otherwise normal grid operating conditions: IEEE1547 default settings mandate the inverter operate only if its terminal voltage is in the  $[+10\%/-12\%] \cdot V_{nom}$  range. To limit these issues, the system designer must consider the worst case grid voltage conditions and wiring run lengths between the inverter to the point of common connection, and size wiring appropriately. For North America, based on ANSI B values, the worst case voltage range is  $\pm 6\%$  of  $V_{nom}$  and line voltage drop in this case should be limited to *less than* 3% of  $V_{nom}$ . Lower is better, so not to dissipate harvested power as heat.

## AC overcurrent protection

AC output overcurrent protection is not provided in the inverter; it is the responsibility of the end user to provide overcurrent protection for the AC output circuit. To reduce the risk of fire, connect only to a dedicated circuit provided with overcurrent protection in accordance with the NEC (ANSI/NFPA 70):

PVS-60.0-TL-US	
Type	Typical installations use a 3-pole/600V rated bi-directional thermalmagnetic circuit breaker, UL489 or equivalent.
Maximum Current/Voltage	100 A / 600 V

- Verify that the PV module is listed for use in 1000Vdc systems in accordance with local electrical codes.
- It is the responsibility of the installer to provide external disconnect switches and Overcurrent Protection Devices (OCPD) as required by National Electric Codes and other prevailing regulations.
- An automatic overcurrent device (e.g., circuit breaker) must be installed between the inverter and the AC utility grid. The maximum acceptable current rating is 100 Amps.
- The inverter is designed without an isolation transformer and must be installed per NFPA 70, 690.35 with an ungrounded PV array.

## sizing the configurable relay (ALARM and AUX)

Different types of devices (light, sound, etc.) can be connected to the relay, provided they comply with the following requirements:

### Alternating current

Maximum Voltage: 240 V AC

Maximum Current: 1 A

### Direct current

Maximum Voltage: 30 V DC

Maximum Current: 0.8 A

The device (light, audible signal) to be connected at the other end of the wires will determine requirements for both the wire size and insulation type, and the N/O or N/C connection.

### Wire requirements

Conductor cross-section: from 25AWG to 15AWG

## String Fuse sizing (-S / -SC models)

**PVS-60-TL-S(-R)-US**

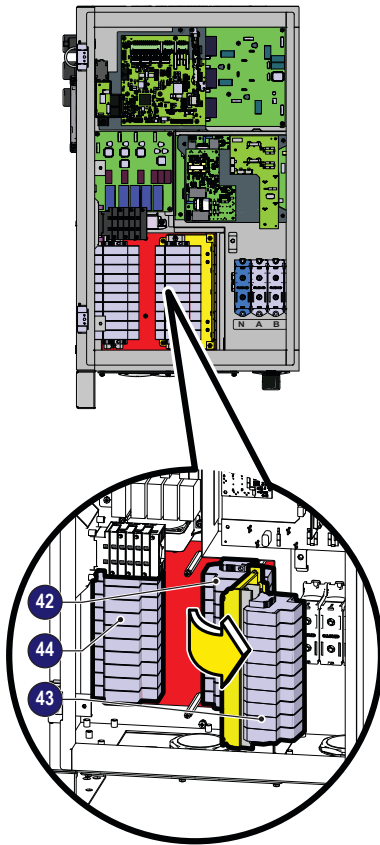

The correct sizing of the positive side (+) and negative side (-) string fuses to be used to protect from “return currents” is very important because it reduces the risk of fire and damage to the PV array.

A “return current” can be generated in the event of a fault and short circuit at the ends of one or more PV modules. This can result in all the current supplied by the strings not involved in the fault, but in the same array, to pass through the faulty string.

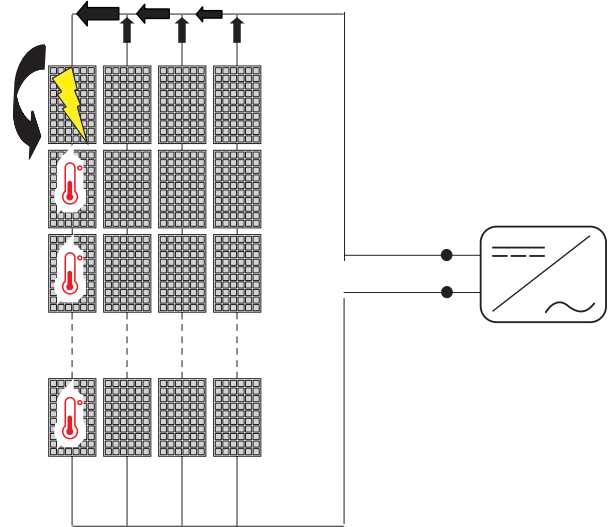

Fuses must be sized for each single string in the PV array. Incorrectly sized fuses can result in damage to the fuse itself and an inverter malfunction.

-S models have fuse holders for each individual string conductor pair. Fuses are sized for single-string currents only. Strings may be not paralleled in the PV array. The maximum string fuse size is 20A.

**PVS-60-TL-SC(-R)-US**



Take into the following two conditions when sizing the string fuses:

1. The nominal current of the fuse ( $I_{rated}$ ) must not exceed the maximum series fuse rating found on the PV modules’ technical datasheet and/or product label. This must be in compliance with standard UL 1703:

$$I_{rated} < \text{Maximum series fuse rating}$$

2. The fuse rating ( $I_{rated}$ ) must be based on the string current and on the sizing guidelines provided by the fuse manufacturer to avoid untimely tripping. As a general guideline, the photovoltaic modules’ short circuit current ( $I_{sc}$ ) and the following formula give an estimate of the fuse rating.:

$$I_{rated} > 1.25 * 1.25 * I_{sc}$$

Fuses must be chosen from among the standard commercially available ratings, selecting the size that is closest to the calculated value.

This estimate takes into consideration derating factors and corrections such as:

- increase in the effective irradiation of the installation area
- Increase in the  $I_{sc}$  based on high PV module temperature
- fuse thermal derating
- maximum return current of the PV modules

15A fuses are available from FIMER:

Code	Description	Quantity
KIT 10 FUSES 15A	Kit of 15A fuses	10



*For more precise calculations, taking into account actual installation conditions, consult documents supplied by the fuse manufacturer.*



## Installation procedure for quick-fit connectors

The model of connectors installed on your inverter must be matched by the same model of the respective corresponding parts to be used (check the corresponding part on the manufacturer's website or with FIMER).



Using mating parts that are not compliant with the quick fit connector models on the inverter could cause serious damage to the unit and lead to invalidation of the warranty.



**CAUTION:** To avoid damage to the equipment, when crimping cables to the connectors, pay particular attention to polarity.



Complete assembly instructions and specification of quick-fit connectors could be find on manufacturer website.

Input cables must meet the connector requirements (cable diameter, conductor cross section) and depends from connector models as shown in the table below:

Type	Manufacturer	Model	P/N	Conductor cross section	Ø cable gland
Male	Stäubli	PV-KBT4-EVO 2	32.0087P0001-UR	4 - 6 mm <sup>2</sup>	4.7 - 6.4 mm
			32.0089P0001-UR	4 - 6 mm <sup>2</sup>	6.4 - 8.4 mm
			32.0093P0001-UR	10 mm <sup>2</sup>	6.4 - 8.4 mm
Female	Stäubli	PV-KST4-EVO 2	32.0086P0001-UR	4 - 6 mm <sup>2</sup>	4.7 - 6.4 mm
			32.0088P0001-UR	4 - 6 mm <sup>2</sup>	6.4 - 8.4 mm
			32.0092P0001-UR	10 mm <sup>2</sup>	6.4 - 8.4 mm

- Strip the cable over a length of 6,0 to 7,5mm using suitable equipment.

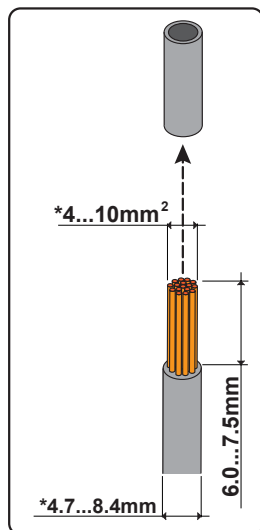

(\*): depending on connector models

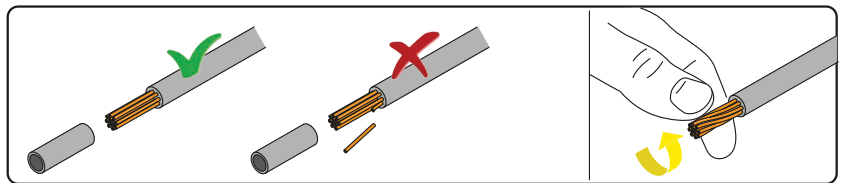

- Crimp the terminal to the conductor using the designated pliers.

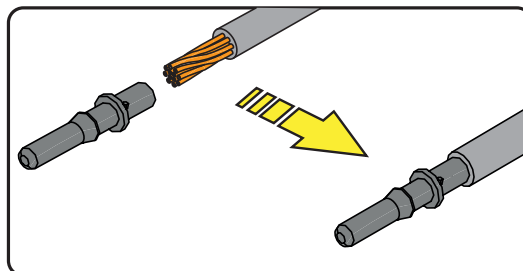

- Insert the crimped terminal contact into the insulator body of the connector, until you hear the click indicating that the terminal is engaged inside the connector.

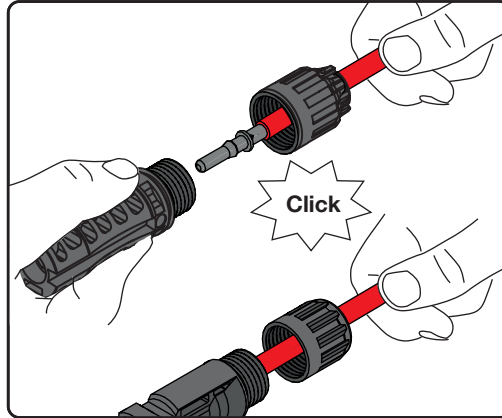

- Firmly tighten the cable gland using the relevant tool to finish the operation.

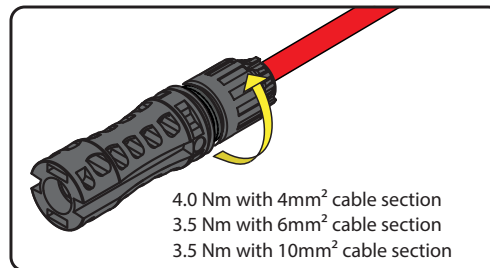

## Installation site and position

- Consult technical data to confirm the environmental specifications will be met
- Installation of the unit in a location exposed to direct sunlight is acceptable.
- Do not install in closed spaces where air does not freely circulate,
- Do not install in spaces inhabited by people or animals due to the potential audible noise level of an operating inverter.
- Always ensure that the airflow around the inverter is not restricted or blocked, so as to prevent overheating.
- Do not install the equipment near flammable substances
- Do not install the equipment on wooden walls or supports, or other flammable substances.
- Maintain minimum clearance from objects blocking air circulation and maintain minimum spacing between inverter as indicated in the figures.

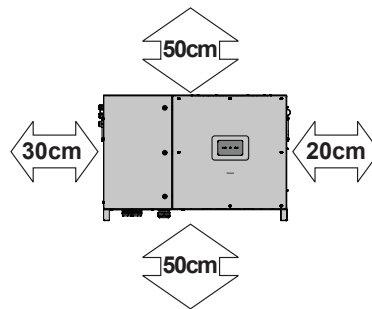

- Install on a wall or strong structure capable of bearing the weight
- Ensure sufficient working area in front of the inverter for wiring box access
- If possible, install at eye level so that the LEDs can be easily seen
- Install at a height that takes account of the weight of the equipment
- All installations over 6500' (2,000 meters) must be assessed by FIMER Technical Sales to determine the proper datasheet derating
- Install vertically or horizontally (i.e. with the inverter on its back), with a maximum inclination as indicated in the figure

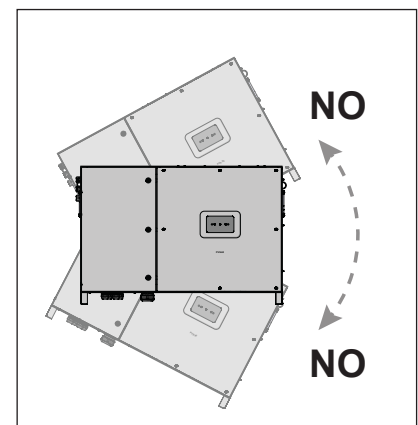
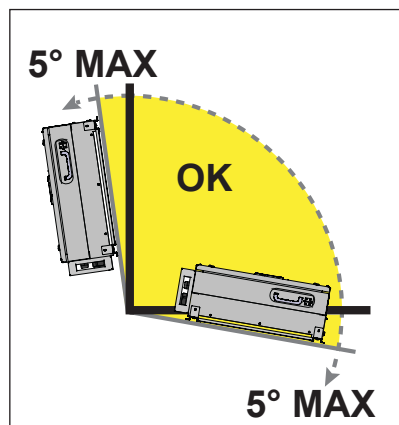

- Position multiple inverters side by side, maintaining minimum clearances, measured from the outermost edge of the inverter. Keep in mind clearance and approach required for any removal or replacement!

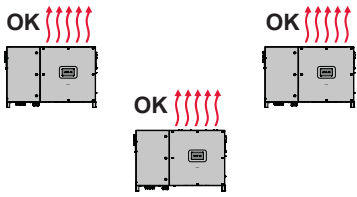
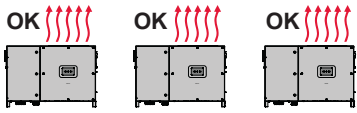

- Multiple inverters can also be placed in a staggered arrangement. Minimum clearances for staggered arrangements include the width of inverter plus additional allowances for inverters arranged above or below

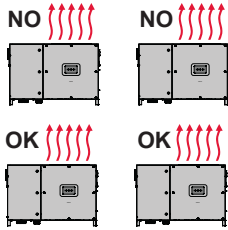

- The vertical installation is also permitted on a structure which must be composed of a support for the attachment of the bracket and one for the support of the rear pins.

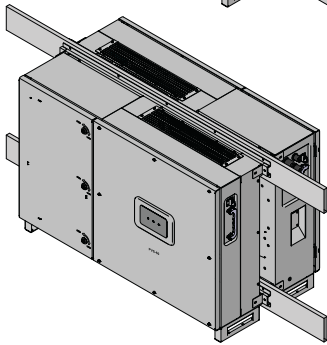
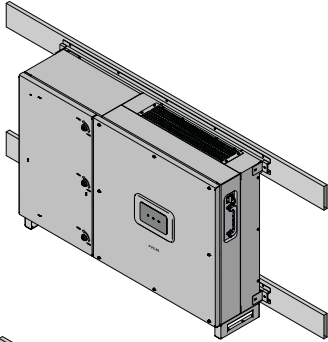

- The vertical installation of two inverters positioned back to back is also permitted on a structure which must be composed of a support for the attachment of the brackets and one for the support of the rear pins.



*Do not block access to the external AC and DC disconnects.*



*Please refer to the warranty terms and conditions to avoid any possible warranty exclusions due to improper installation.*

## Wireless signal environmental checks

The inverter can be commissioned and monitored using the wireless communication channel. The WLAN board of the inverter uses radio waves to transmit and receive data, it is therefore important to assess this factor in order to have optimal installation.

- Walls in reinforced cement and surfaces covered in metal (doors, shutters, etc.) can reduce the reach of the device (approximately 55 yards in free space).
- It is therefore recommended that before installing the inverter, the strength of the wireless signal is checked, using a mobile device (smartphone, tablet or notebook) and connecting to the wireless router from a position close to the installation site of the inverter.

The radio signal level between the inverter and the wireless router can be improved in a number of ways:

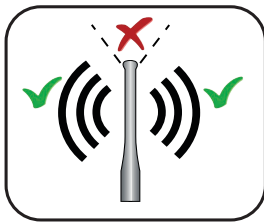

1. Change the direction of the antenna.

The antenna has a dead zone at its tip, which should not be positioned facing the wireless router, as shown in the figure.

2. Find a new position for the router considering the different types of materials which the radio signal will have to pass through:

Material	Relative signal reduction
Open field	0% (strength of approximately 50 meters)
Wood / Glass	From 0 to 10%
Stone / Plywood	From 10 to 40%
Reinforced concrete	From 60 to 90%
Metal	Up to 100 %

The quality of the RF signal can be assessed during the installation stage where the signal is displayed in dBm.

3. Install a wireless signal repeater and place it in an area between the inverter and the router, trying to make sure that the most critical obstacles are avoided.

## Installations above 2000 meters



*On account of the rarefaction of the air (at high altitudes), particular conditions may occur that should be considered when choosing the place of installation:*

- Less efficient cooling and therefore a greater likelihood of the device going into derating because of high internal temperatures.
  - Reduction in the dielectric resistance of the air which, in the presence of high operating voltages (DC input), can create electric arcs (electrical discharges) that may damage the device.
- As the altitude increases, the failure rate of some electronic components increases exponentially because of cosmic radiation.



*All installations at altitudes exceeding 2000 meters are prohibited on the basis of the criticalities indicated above.*

## Installations with a high level of humidity



*Never open the inverter in the case of rain, snow or a level of humidity >95%.  
Always carefully seal all unused openings.*

Even though the device is equipped with an anti-condensation valve, air with extremely high levels of humidity can lead to the creation of condensation inside the inverter.

As the inverter is almost completely insulated from the outside, condensation can also form after installation in certain weather conditions.

# Mounting of the inverter on the bracket

The mounting bracket can be used to install the inverter on a vertical or horizontal support.

- Position the bracket **01** perfectly level on the support and use it as drilling template.

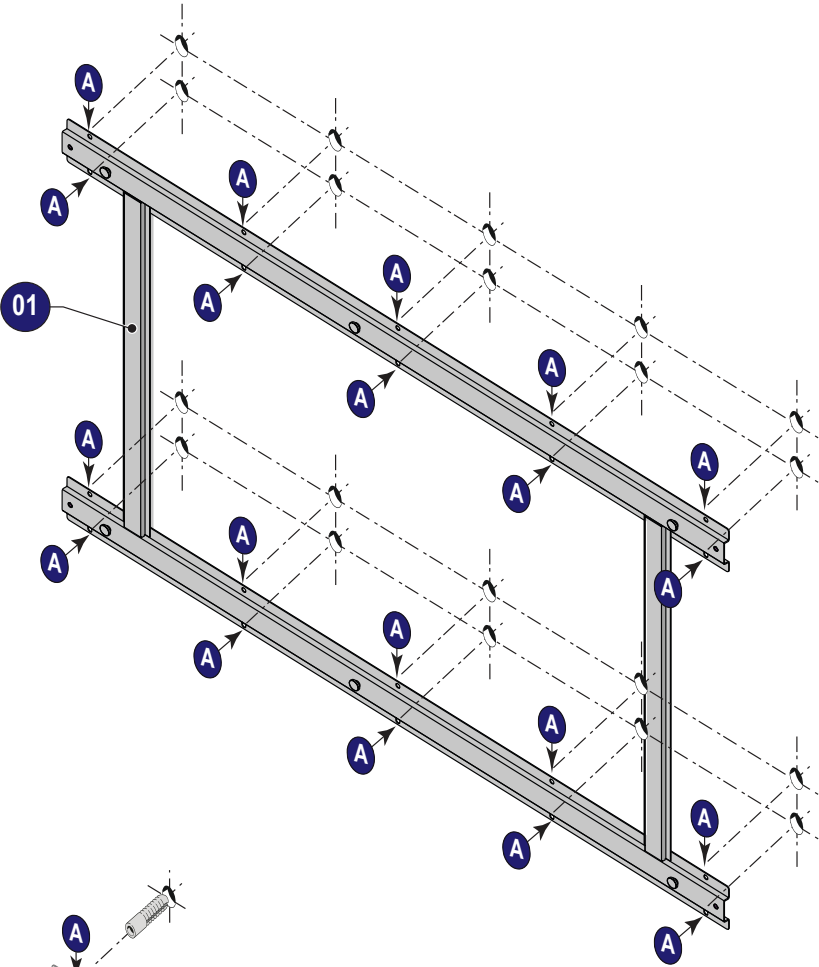

- It is the installer's responsibility to choose an appropriate number and distribution of attachment points. The choice must be based on the type of support (wall, frame or other support), the type of anchors to be used, and their ability to support 4 times the inverter's weight ( $4 \times 70\text{Kg} = 280\text{Kg}$  for all models).

Attach the bracket to the wall with at least 10 attachment screws. Depending on the type of anchor chosen, drill the required 10 holes (minimum) **A** to mount the bracket. Put at least four screws in the upper side and at least four in the lower side (see example in the illustration)

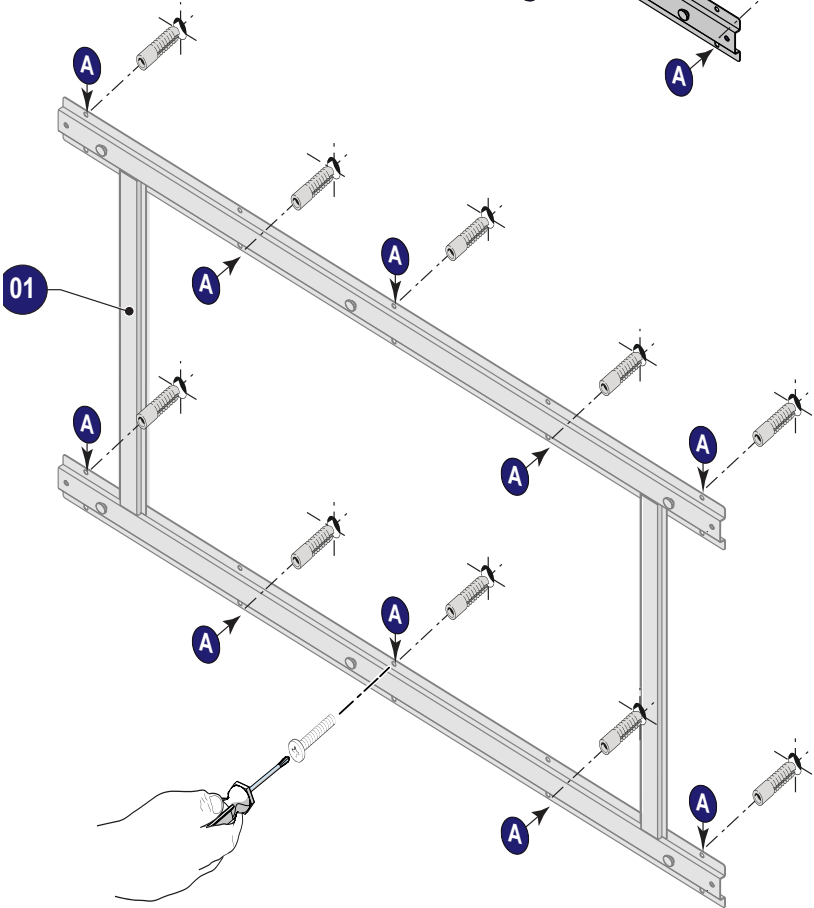

- Fix the bracket to the support.

000867AG-F

- Lift the inverter up to the bracket using the handles **14** , or another appropriate lifting device. The inverter is pre-equipped with lower support **24** which allow it to be temporarily put vertically on the floor to make it easier the lifting.



Risk of injury due to the heavy weight of the equipment.

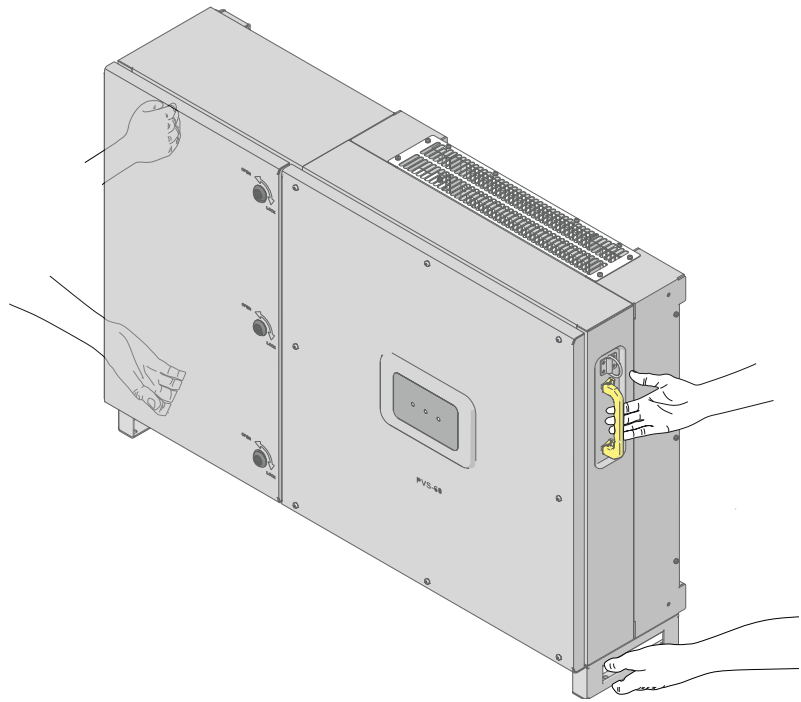

- Insert the heads of six anchor point **03** present on the bracket into the slots  on the rear of the inverter.

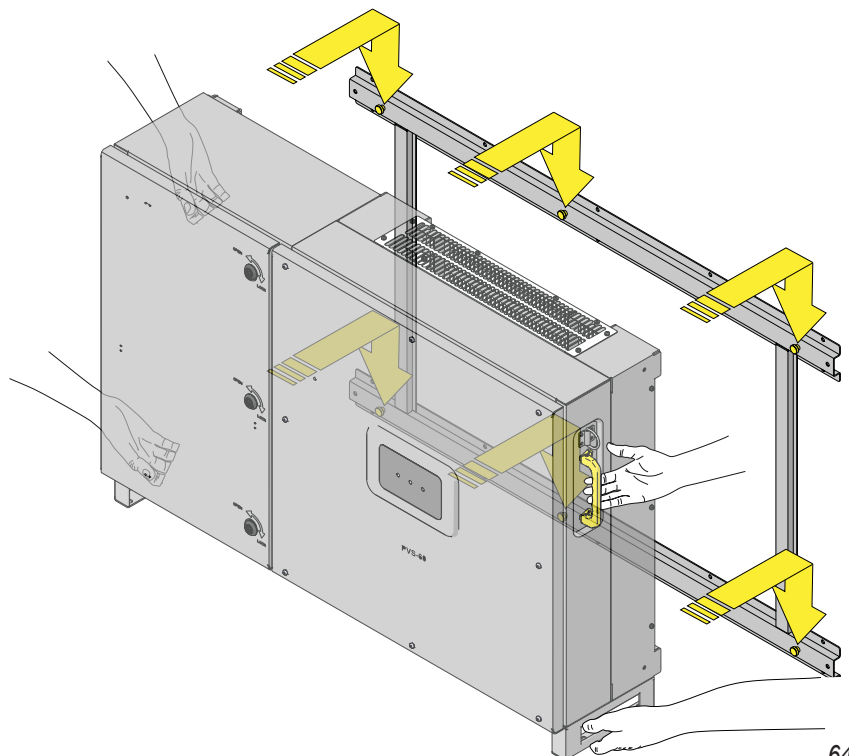
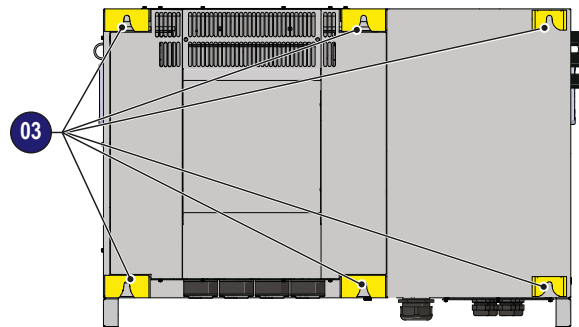



- Install the 4 fixing bracket on the 4 locking brackets attachment point 11 (one for each corner of the inverter) using the supplied 8 screws.

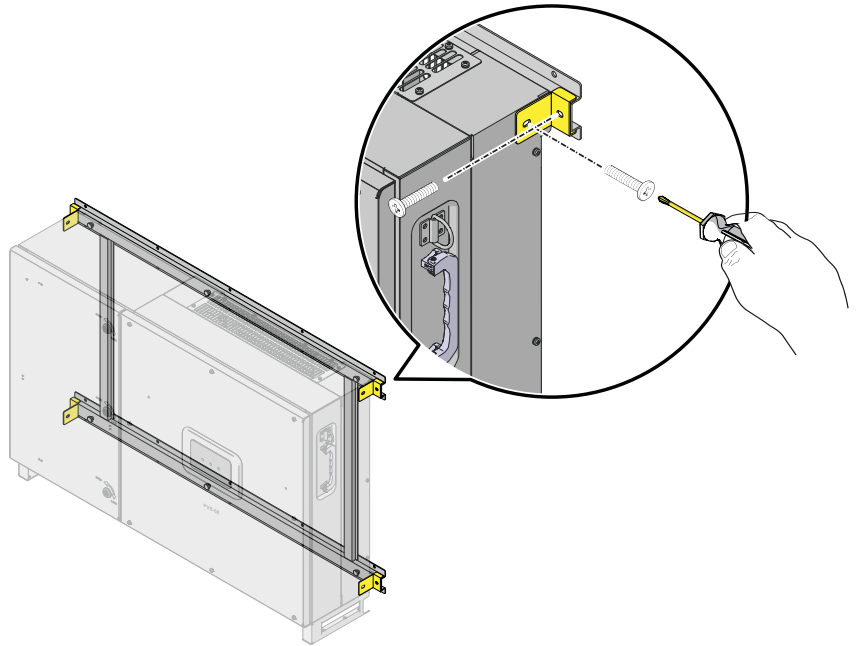

- Remove the protective cover from the connector of the wireless antenna located on the left side of the inverter. Install the wireless antenna by screwing it into the specific connector .10

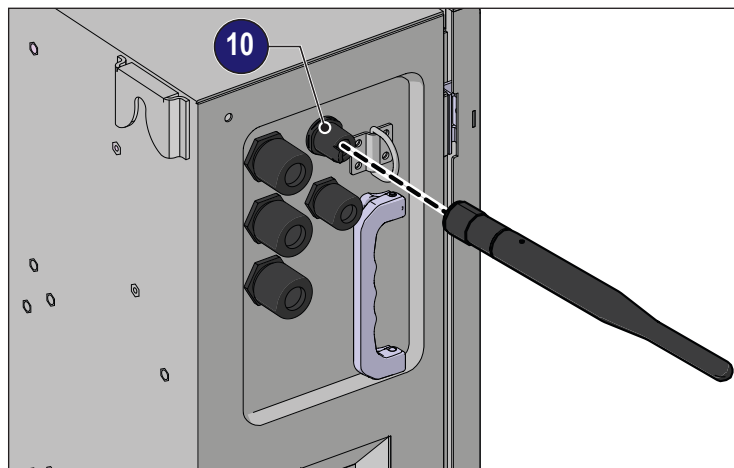

- Open the wiring box front cover turning the 3 key-lock 08 in "OPEN" position and proceed with the wiring and connections depending on the model.

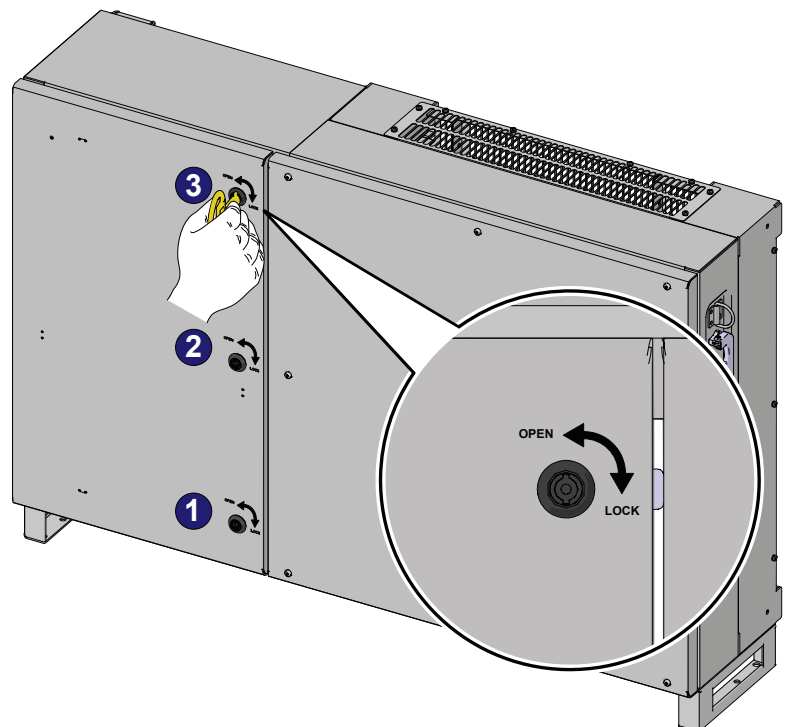

## Installing the ground cable(s)

Connect the ground cables of the DC side to the equipment grounding conductor terminal (EGC) **16**.

EGC connection point accept a ring cable lug, suitable for a M6 size threaded insert (torque to 11Nm/8ft-lb)

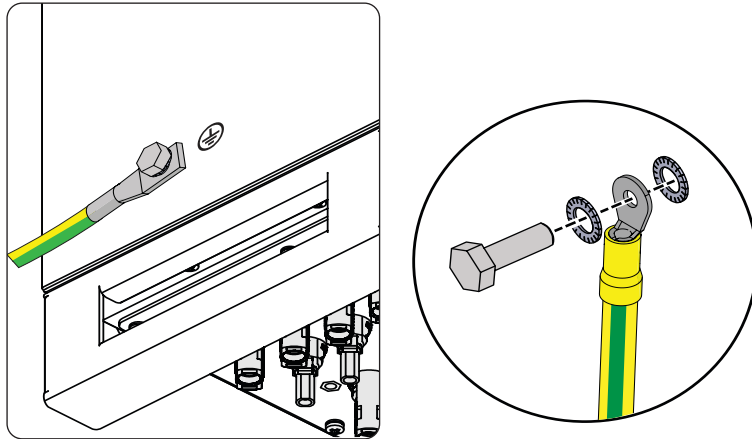

Attach the AC side ground cable to the protective earth (PE) connection point **37**.

The protective earth (PE) connection point accept a ring cable lug, suitable for a M6 size threaded insert (torque to 11Nm/8ft-lb).

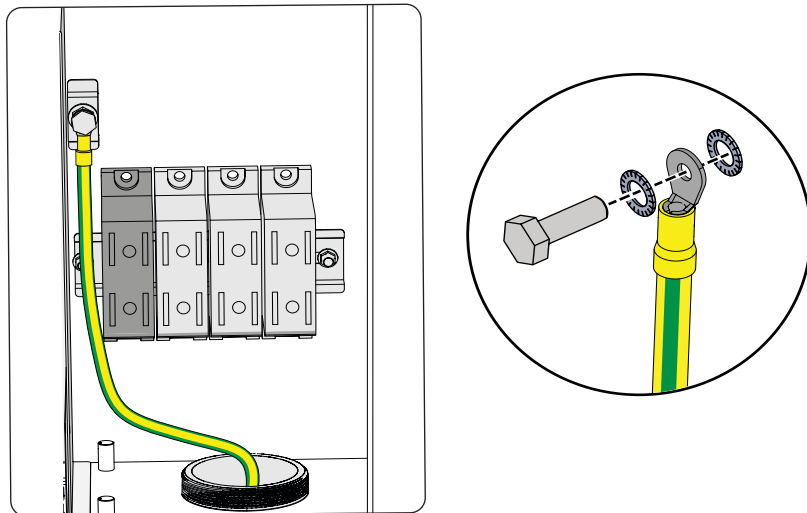

## Grid output connection (AC side)

The medium voltage transformer, i.e. the grid (distribution system), must face the inverter as a **grounded WYE**, whose Neutral may or may not be brought to the inverter:

- Lines R,S,T, Neutral + GND (“four-wire”) OR
- Lines R,S,T+ GND (“three-wire,” and in this case, the inverter creates its own “virtual” neutral)

**Delta connections to the grid are NOT permitted.**



*Caution! Connect the ground before the grid connections.*

### Connection to the AC terminal block



*To prevent electrocution hazards, open and lock out /tag out the external AC disconnect switch before connecting the AC conductors, and any time the AC wiring box cover is to be removed. Proper PPE is required.*



*Caution! Confirm the ground connection before starting the grid connections.*

- Confirm the size of grid conductors 4AWG to 3/0AWG (copper or aluminum)
- Confirm the right setting of the switch on the AC filter board for the neutral connection to the grid:  
3WIRES → WYE connections with no neutral (R+S+T+GND)  
4WIRES → WYE configurations with neutral (R+S+T+N+GND)
- Run the AC cable through the conduit openings <sup>18</sup>.
- Connect the grid conductors (R,S,T Neutral) to the respective terminals on the AC output terminal block <sup>38</sup>. Observe the connection sequence of the phases R,S,T otherwise the inverter will enter in error state.
- Torque to 14Nm / 10.3 ft-lb
- Give each wire a pull test to confirm the connection is secure.
- Conduit must be attached using liquid tight fittings to maintain Type 4 enclosure integrity.

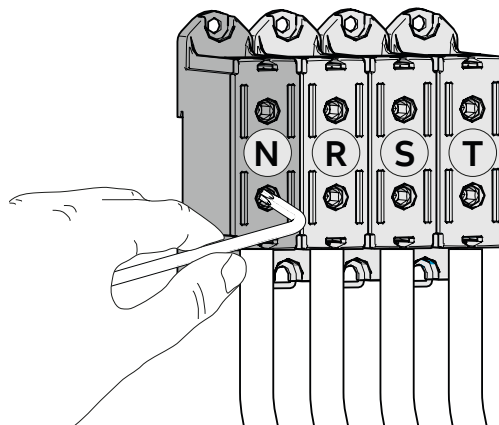

## Operations preliminary to the connection of the PV generator

### Confirm the PV arrays have no ground leakage



All the following activities must be performed wearing the PPE and using appropriate measuring devices.

Measure the voltage present between positive and negative terminal of each string with respect to ground.

If voltage is measured between an input terminal and ground, there may be low insulation resistance in the PV array. Before installation, the low insulation resistance must be located, and the problem repaired.



Do not connect the strings if leakage to ground has been detected, as the inverter will not connect to the grid.

#### Behavior of a system without leakage:

Due to stray capacitance inherent in the PV array, a voltmeter connected between an input terminal and ground will initially read about  $V_{oc}/2$ , then bleed off to  $\sim 0V$  if there is no ground leakage. This is shown in the graph below:

The internal resistance of the voltmeter tends to bleed off the voltage on any PV array capacitance.

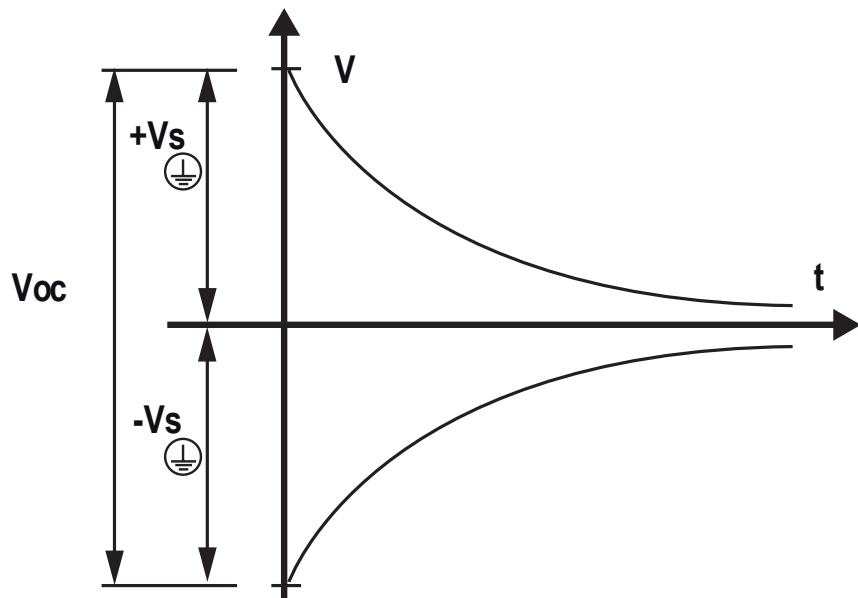

How to make the measurement:

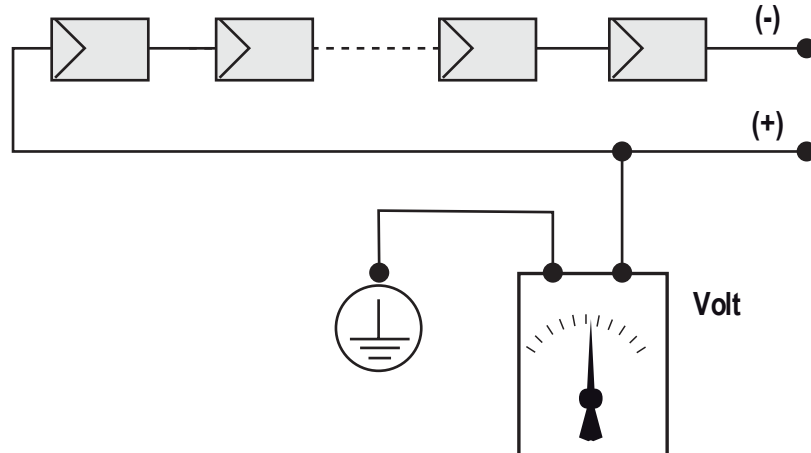

#### Behavior of a system with leakage



All the following activities must be performed wearing the PPE and using appropriate measuring devices.

If the voltage measured between one of the two terminals and ground does not discharge to 0V, but stabilizes on a non-zero value, there is ground leakage from the PV array.

Example: If the measurement is made between positive terminal and ground, and a voltage of 200V is measured....

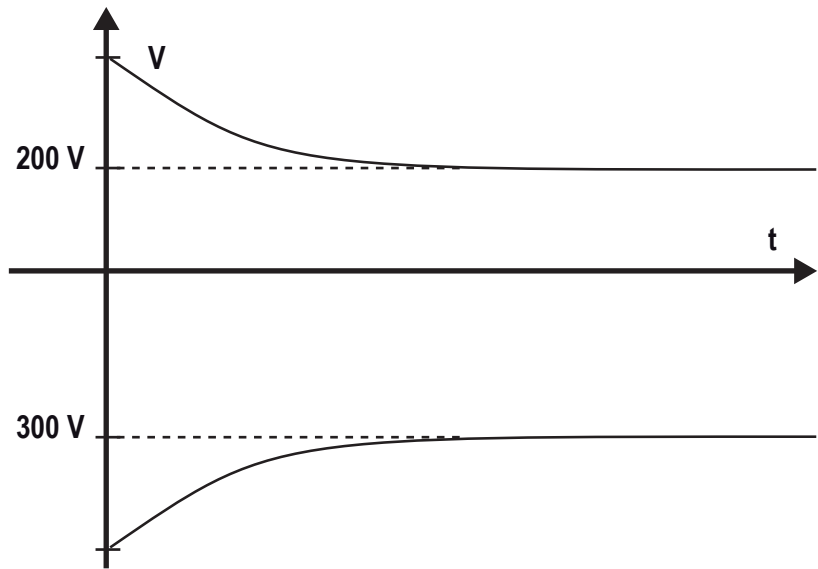

This means that if the system is made up of 10 modules in series and each one supplies 50V, the leakage is located between the 4th and 5th PV module.

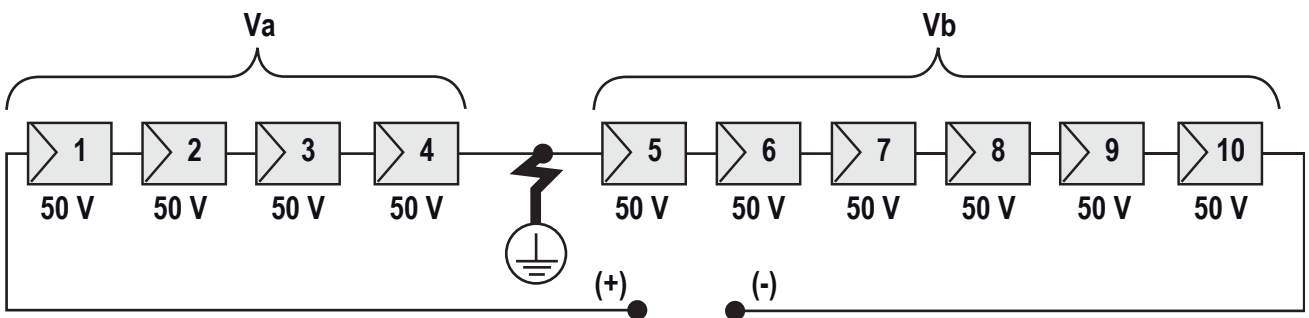

$V_a$  = voltage measured between + terminal and  $\oplus$  = 200V  
 $V_b$  = voltage measured between - terminal and  $\oplus$  = 300V  
 In all measurements with  $\oplus$ , the ground of the inverter is indicated.

## Measuring the insulation resistance of the PV array.



The operator must always use the personal protective equipment (PPE) required by the laws of the country of destination and whatever is provided by their employer.

To measure the insulation resistance (from ground  $\oplus$ ) in the PV array, the two terminals of the PV array must be short circuited (using a suitably sized short).



Use of inappropriate sized switch could cause risk of fire or electric arc! Use only 1500V rated switch!

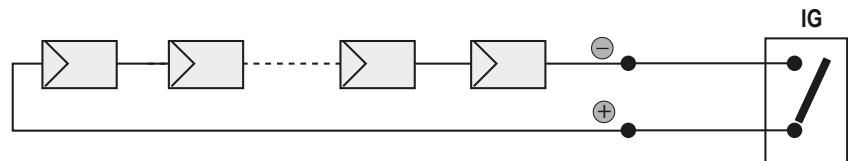

Once the short circuit has been made, measure the insulation resistance (Riso) using a megohmmeter positioned between the two shorted terminals and ground (of the inverter).

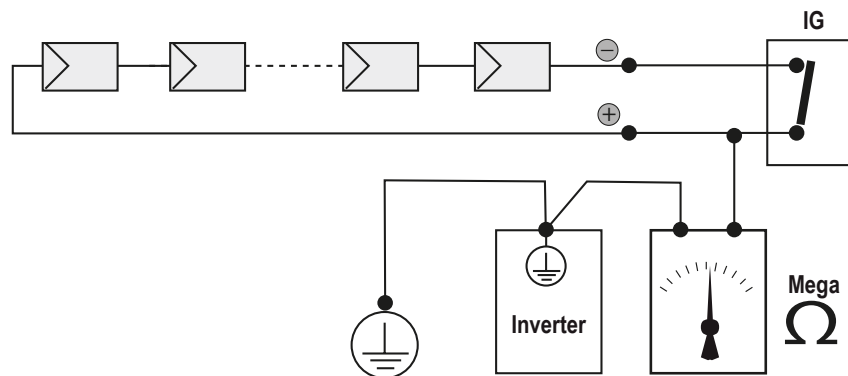

If the measured insulation resistance (Riso) is less than 100 KOhm, the inverter may not connect to the grid because of low insulation resistance to ground in the PV array.

*The insulation resistance will be affected by the environmental conditions. The measurement must be made immediately after the anomaly is detected, especially if the PV array is damp after rain, dew or overnight humidity,*

## Confirm string voltage and correct polarity

In full sun, measure the positive (+) to negative (-) voltage for each string in the PV array. Confirm the polarity is correct.

If the open circuit voltage (Voc) is anywhere near the inverter maximum input voltage rating, stop and confirm that during a full sun start up on the coldest possible day of the year, the PV string will not exceed 950Vdc. If it seems it might be approach 950Vdc, reduce the number of PV modules in the string(s) to avoid out-of-warranty damage to the inverter.

## Independent or parallel input channels configuration

The inverter equipped with DC wiring box -S and -SC versions have three input channels (thus benefiting from three trackers for MPPT maximum power point tracking) which work independently of one another, which can be paralleled by leveraging a single MPPT.

Strings of photovoltaic modules having the same type and number of panels in series must be connected to each single channel; they must also have the same installation conditions (in terms of orientation to the SOUTH and inclination from the horizontal plane).

When connecting the three input channels in parallel, you must comply with the above requirements in order to benefit from the ability to leverage the full power of the inverter output on a single channel.

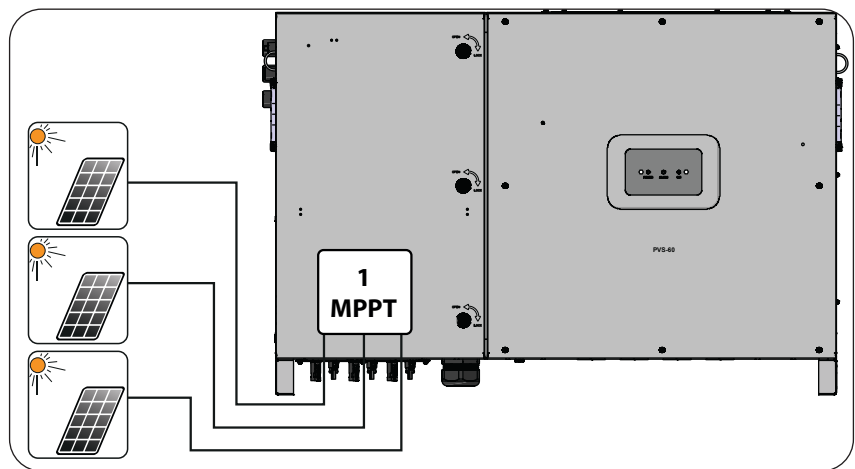

The multi MPPT structure however allows management of three photovoltaic generators which are independent of each other (one for each input channel), and which may differ between themselves with regard to installation conditions, type and number of photovoltaic modules connected in series. A necessary condition for the three MPPT to be used independently is that the photovoltaic generator connected to each of the inputs has a lower power than the power limit of the single input channel and a maximum current lower than the current limit of the single input channel.

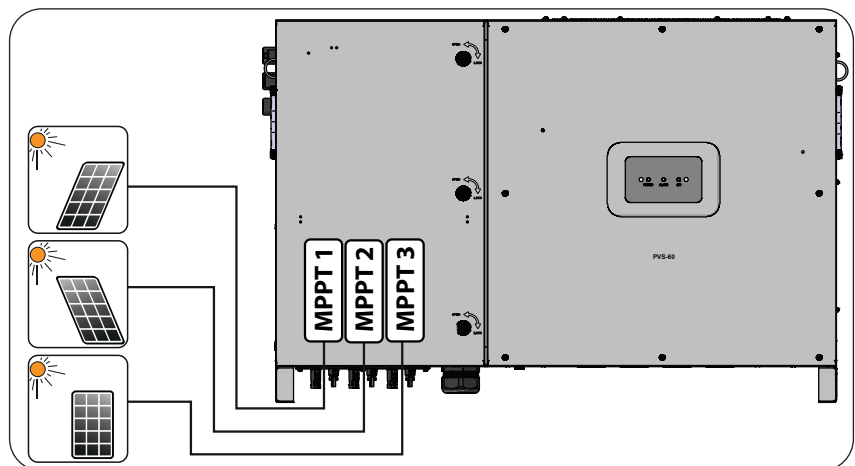

All input parameters that must be met for correct inverter operation are shown in the "technical data" table.

## Channel configuration examples

PV generator characteristics	MPPT configuration	Notes
<p>The photovoltaic generator consists of strings having a <b>different</b> number of modules in series from each other.</p> <p>The photovoltaic generator consists of strings that have <b>different</b> installation conditions from each other.</p>	<p><b>MPPT configuration has to be INDEPENDENT</b></p>	<p>A <b>NECESSARY</b> condition so that the three MPPTs can be used in independent mode is for the photovoltaic generator connected to each of the inputs to have a power <b>lower</b> than the power limit of the single input channel <b>AND</b> a maximum current <b>lower</b> than the current limit of the single input channel.</p>
<p>The photovoltaic generator consists of strings having the <b>same</b> number of modules in series as each other.</p> <p>The photovoltaic generator consists of strings that have the <b>same</b> installation conditions, that is to say, all the strings have the <b>same</b> inclination from the horizontal and the <b>same</b> orientation to the SOUTH.</p> <p>The photovoltaic generator connected to each of the inputs has a power <b>lower</b> than the power limit of the input channel <b>AND</b> a current <b>lower</b> than the current limit of the input channel.</p>	<p><b>Possibility of choosing between the configuration with MPPT as INDEPENDENT or PARALLEL</b></p>	<p>A <b>NECESSARY</b> condition so that the three MPPTs can be used in independent mode is for the photovoltaic generator connected to each of the inputs to have a power <b>lower</b> than the power limit of the input channel <b>AND</b> a maximum current <b>lower</b> than the current limit of the input channel.</p> <p>An <b>ADVISABLE</b> (*) condition so that the three MPPTs can be connected in parallel is for the photovoltaic generator connected to the three inputs to consist of strings made by the <b>same</b> number of modules in series and for all the modules to have the <b>same</b> installation conditions.</p>
<p><i>(*) This condition is advisable from the point of view of the energy production of the system, not from the point of view of inverter operation.</i></p>		
<p>The photovoltaic generator consists of strings having the <b>same</b> number of modules in series as each other.</p> <p>The photovoltaic generator consists of strings that have the <b>same</b> installation conditions, that is to say, all the strings have the <b>same</b> inclination from the horizontal and the <b>same</b> orientation to the SOUTH.</p> <p>The photovoltaic generator connected to each of the inputs has a power <b>higher</b> than the power limit of the input channel <b>OR</b> a current <b>higher</b> than the current limit of the input channel.</p>	<p><b>MPPT configuration has to be PARALLEL</b></p>	<p>A <b>SUFFICIENT</b> (*) condition so that the three MPPTs must be used in parallel mode is for the photovoltaic generator connected to each of the inputs to have a power <b>higher</b> than the power limit of the single input channel <b>OR</b> a maximum current <b>higher</b> than the current limit of the single input channel.</p> <p>An <b>ADVISABLE</b> (**) condition so that the three MPPTs can be connected in parallel is for the photovoltaic generator connected to the three inputs to consist of strings made by the same number of modules in series and for all the modules to have the same installation conditions.</p>
<p><i>(*) This condition is sufficient from the point of view of the energy production of the system, not from the point of view of inverter operation.</i></p>		
<p><i>(**) This condition is advisable from the point of view of the energy production of the system, not from the point of view of inverter operation.</i></p>		



## Independent channel configuration (default configuration)

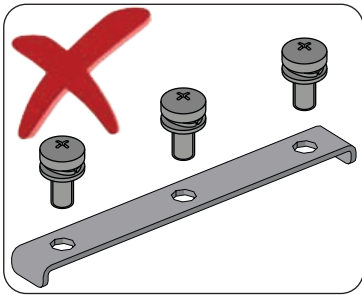

In the -S and -SC inverter models, the independent configuration of the input channels (MPPT) is set at the factory. This means that the parallel bar (supplied) must not be installed on the parallel MPPT connection points 41, and that the software setting “Independent channel mode” should be performed on the inverter; this setting can be done by different way:

1. During the commissioning wizard phase (STEP 4)
2. In the dedicated section of the internal webserver “**Setup section > Setup DC side > Input mode**”

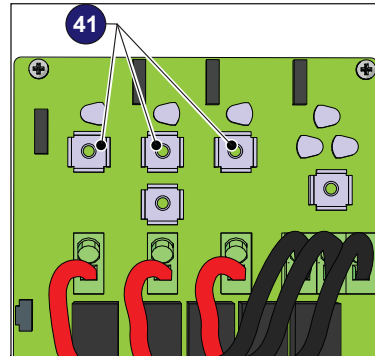

*In the standard model (PVS-60-TL-US) is available only one input channel and therefore not possible to set the inputs as independent*

## Parallel channel configuration

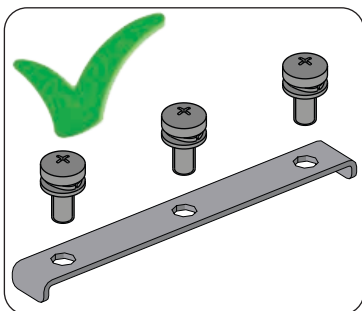

In the -S and -SC inverter models, the configuration of the input channels (MPPT) can be set in parallel. This means that the parallel bar (supplied) must be installed on the parallel MPPT connection points 41, and that the software setting “parallel channel mode” should be performed on the inverter; this setting can be done by different way:

1. During the commissioning wizard phase (STEP 4)
2. In the dedicated section of the internal webserver “**Setup section > Setup DC side > Input mode**”

To install the parallel bar follow the procedure below:

- Place the parallel bar (supplied) on the connection points
- Install the 3 screws with washers supplied (torque 4Nm / 3.0 ft-lb)

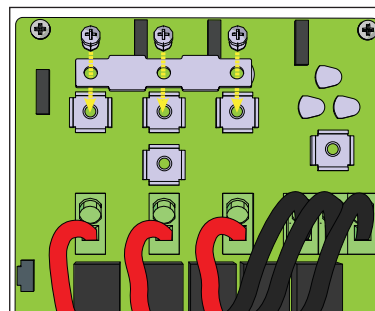

## DC input connection

After having carried out preliminary checks and therefore having verified that there are no problems in the photovoltaic system, and the channel configuration has been selected (parallel or independent) you may connect the inputs to the inverter.



According to the system configuration, check the correct setting of the channels to independent or in parallel mode. An incorrect setting of the input channels can lead to loss of energy production.



Comply with the maximum input current relating to the quick-fit connectors as indicated in the technical data.



Polarity inversion can cause serious damage. Check polarity before connecting each string!



When the photovoltaic panels are exposed to sunlight they provide continuous DC voltage to the inverter. To avoid risks of electrical shock, **all wiring operations must be carried out with the DC disconnect switch (internal or external to the inverter) OFF.**



The DC disconnect switch disconnects the DC current from the PV panels in the "OFF" position. The inverter will stop producing power, but **DOES NOT** disconnect the AC from the grid. To prevent electrocution hazards, all the connection operations must be carried out with the external AC disconnect switch (grid side) of the inverter open and locked out.

The transformerless design of the inverter requires that the PV array be floating with respect to ground, per NEC 690.35.

Per NEC 690.35, wires from the PV array must be listed by accredited NRTL, 1000V minimum rating, 90°C minimum temperature rating.

The DC side connections are different according to the wiring box used:

- **STANDARD** - Conduits and terminal blocks
- **-S** - Conduits and fuse holders
- **-SC** - Quick fit connectors (one for each pole of each string).

On the **STANDARD** version, the connection in parallel of the strings (array composition) must take place upstream of the input in the inverter and must be made by technicians during installation.

The **-S** and **-SC** versions accept a direct single strings connection with connectors which are located on the outside of the wiring box .

## PVS-60-TL-US - PV input connection

- Confirm that PV array equipment ground wire(s) is connected to the equipment ground connection point **16** (labelled "EGC").
- Confirm the DC cables are 4AWG - 3/0AWG, copper or aluminum.
- Connect PV array to the the DC input terminal block **39** (+ and -).
- Torque screws to 14 N-m (10.3 ft-lb).
- When finished, go back and confirm the polarity is correct for each string.
- Give each wire a pull test to confirm the connection is secure.
- Conduit must be attached using liquid tight fittings to maintain Type 4 enclosure integrity.

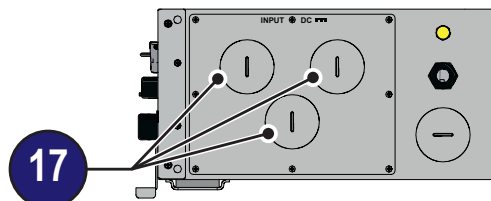
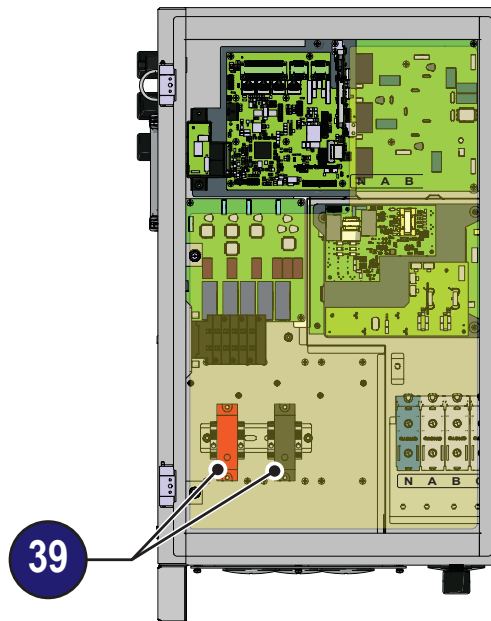

## PVS-60-TL-S-US \_ PV input connection

- Confirm that PV array equipment ground wire(s) is connected to the equipment ground connection point 16 (labelled "EGC").



*-S models have fuse holders for each individual string conductor pair.  
Fuses are sized for single-string currents only.*

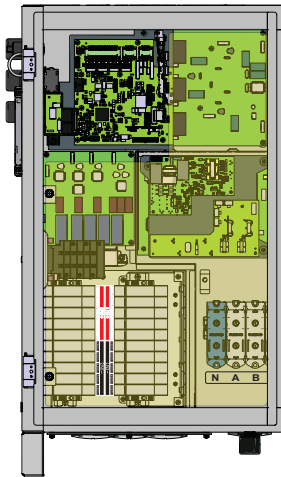

- Confirm that strings are not paralleled in the PV array.
- Confirm that the string fuse size is below of 20A
- Confirm the DC cables are 12AWG to 3AWG
- Connect each string to the fuse holders (+ and -) following site wiring diagrams. The input fuse holder are divided into 3 groups (one group for each input channel) consisting of 5 pairs of quick fit connectors.

See the label near to each fuse holders group to identify the strings connection number (+ and - poles).

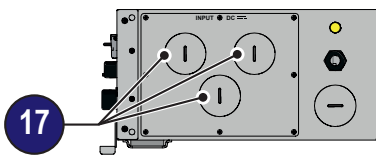
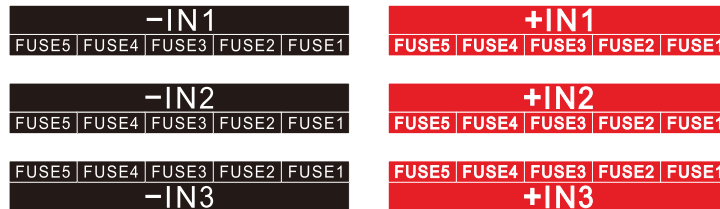

The fuse holders group of the input channel 1 is reachable after have to rotate the fuse holders group of the input channel 2. Remove the two screws and rotate the fuse holders group IN2.

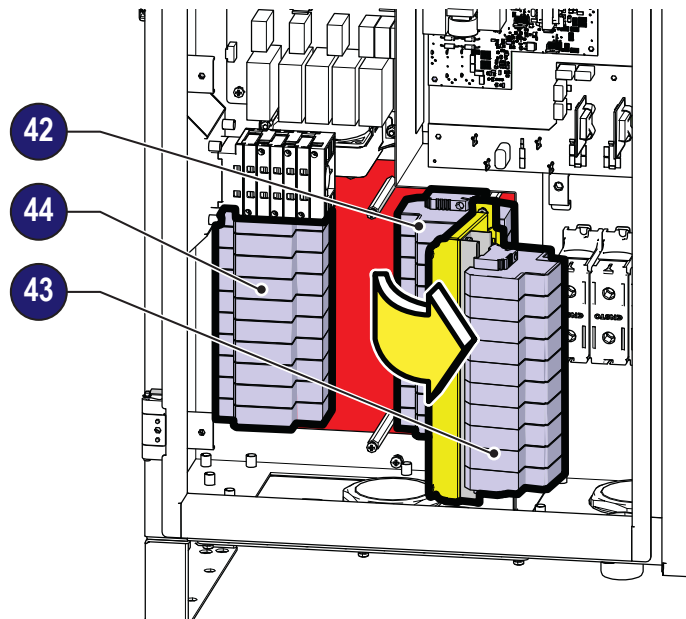

- Torque screws to 3.4Nm (30 in-lb).
- When finished, go back and confirm the polarity is correct for each string.
- Give each wire a pull test to confirm the connection is secure.
- Conduit must be attached using liquid tight fittings to maintain Type 4 enclosure integrity.

## PVS-60-TL-SC-US \_ PV input connection

- Confirm that PV array equipment ground wire(s) is connected to the equipment ground connection point 16 (labelled "EGC").

*-SC model have fuse holders for each individual string conductor pair.  
Fuses are sized for single-string currents only.*

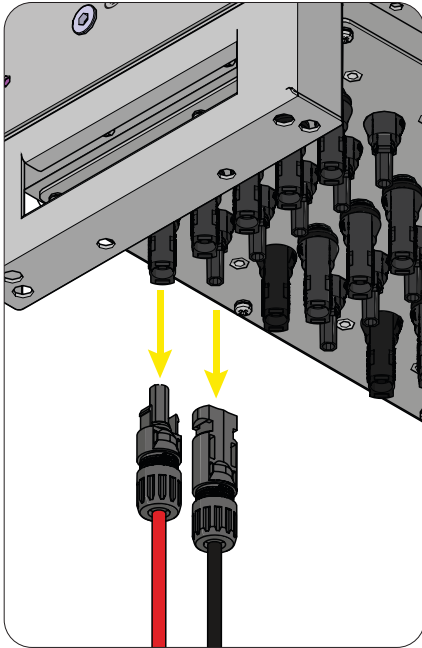

- Confirm that strings are not paralleled in the PV array.
- Confirm that the string fuse size is below of 20A
- Install the quick fit connectors on the string cables following the instruction on the "Installation procedure for quick-fit connectors" paragraph.
- Connect each string to the quick fit connectors (usually MultiContact MC4 located on the bottom of the inverter, following site wiring diagrams. The input connectors are divided into 3 groups (one group for each input channel) consisting of 5 pairs of quick fit connectors.

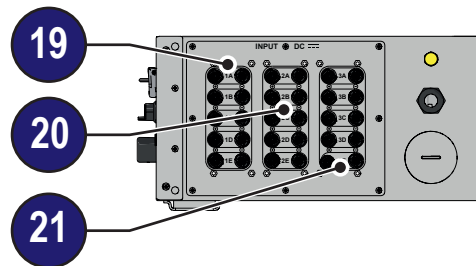

*Refer to the document "String inverter – Product Manual appendix" available at [www.fimer.com](http://www.fimer.com) to know the brand and the model of the quick fit connector. Depending on the model of the connector of the own inverter, it is necessary to use the same model and the respective counterpart (check the compliant counterpart on the website of the manufacturer or in )*

- When finished, go back and confirm the polarity is correct for each string.

- Give each wire a pull test to confirm the connection is secure.



*Using corresponding parts that are not compliant with the quick fit connector models on the inverter could cause serious damage to the unit and void of the warranty.*



*If any string inputs are not required, you must ensure that covers are installed to the connectors, and install any which are missing.*

*This is necessary both for the inverter seal, and to avoid damage to the free connector which may be used at a later time.*



*In these versions of inverter, it is MANDATORY to directly connect the individual strings coming into the inverter (do not make field switchboards for parallel strings). This is because the string fuses, situated on each input, are not rated to take strings in parallel (array). This operation can cause damage to the fuse and consequently malfunctioning of the inverter.*

## Communication and control board

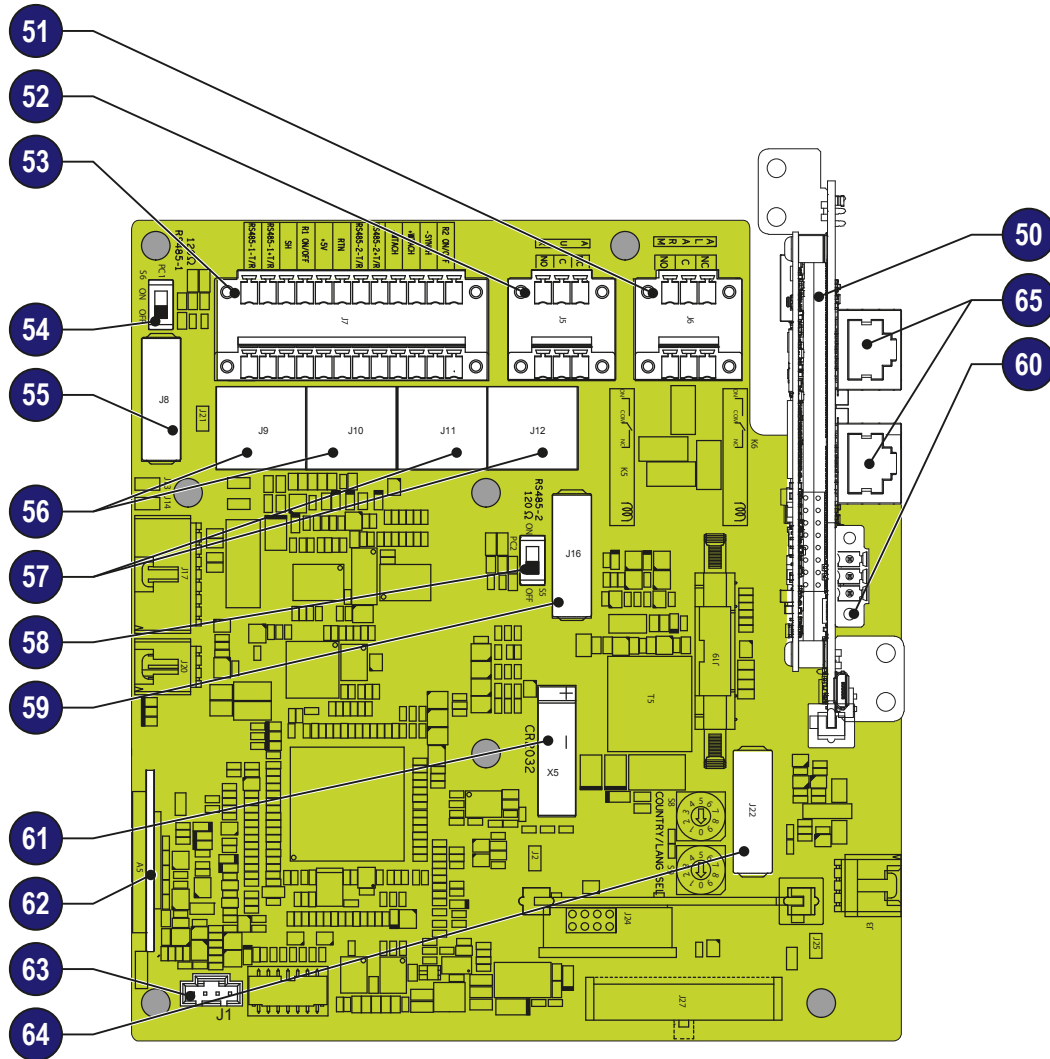

Silkscreen	Reference	Symbol
	50	Interposer board
J6	51	ALARM (multifunction relay) terminal block
J5	52	AUX (multifunction relay) terminal block
J7	53	RS485-1 and RS485-2 lines, R1 ON/OFF and R2 ON/OFF (remote ON/OFF) and 5V auxiliary lines terminal block
S6	54	RS485-1 line 120Ohm termination resistor switch
J8	55	RS485-1 communication card housing
J9, J10	56	RS485-1 line connection on RJ45 connector
J11, J12	57	RS485-2 line connection on RJ45 connector
S5	58	RS485-2 line 120Ohm termination resistor switch
J16	59	RS485-2 communication card housing
J5 on interposer board	60	RS485-MAIN terminal block
X5	61	Battery housing
A5	62	SD card housing
J1	63	Grounding kit connector (optional kit)
J22	64	Inverter data memory card housing
	65	Ethernet connector

## Connections to the communication and control board

The communication and control signals are connected to the communication and control board inside the DC wiring box or directly to the connectors on the outside of the inverter. In particular, on the left side of the inverter, there are 3 different configurations depending on the type of inverter chosen:

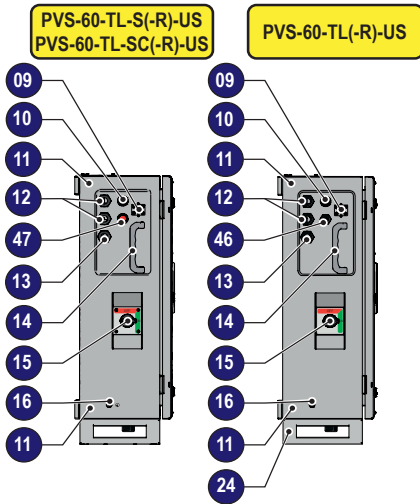

**PVS-60-TL(-R)-US:** This inverter model equipped with 5 holes on which plugs are installed. In particular there are:

- Lifting ring 09.
- Wi-Fi antenna connector 10.
- 2 ethernet cable gland 12.
- Service cable gland (PG21) 13.
- Service cable gland (PG16) 46.

These holes can be used to install conduits or cable gland to pass the signals/ethernet cables inside the wiring box.

**PVS-60-TL-S/-SC(-R)-US:** This inverter model equipped with 5 holes on which plugs are installed. In particular there are:

- Lifting ring 09.
- Wi-Fi antenna connector 10.
- 2 ethernet cable gland 12.
- Service cable gland (PG21) 13.
- AFD reset button 47.

These holes can be used to install conduits or cable gland to pass the signals/ethernet cables inside the wiring box.

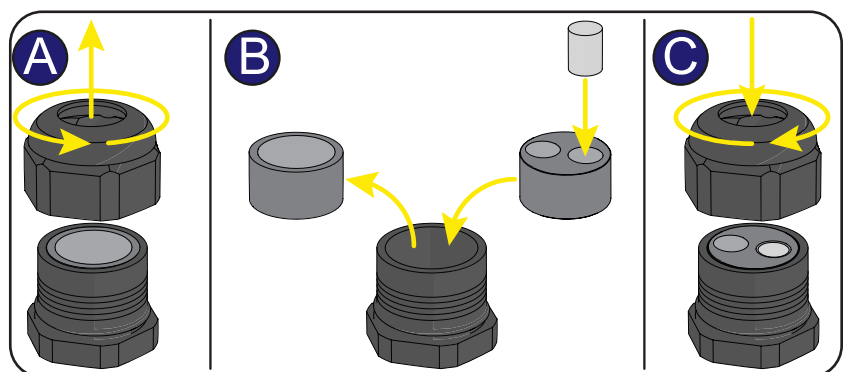

## Ethernet connection configuration



*In order to avoid ground loop (that could create communication issues) the shield of any Ethernet cable must be connected to the RJ45 plug in only one side, the other side of the shield should be leaved floating. This could be guaranteed by crimping the shield or the screen of the ethernet cable to the RJ45 connectors only at one end of each cables.*

Three topologies of ethernet connection to the router are available:

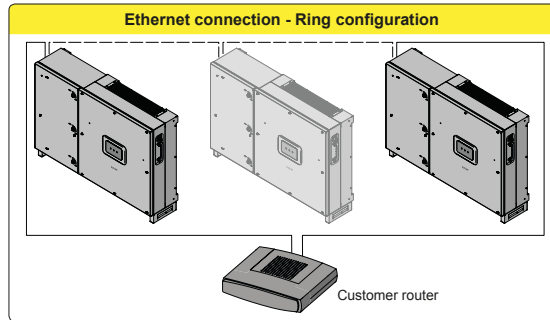

*The ring configuration is the preferable way to connect the units in order to allow reaching inverters in case of single inverter fault.*



*In case inverters are connected to the networking switch with a ring topology is recommended to enable SPT protocol on the switch (Spanning Tree Protocol SPT (IEEE 802.1D) is enabled by default on inverters).*

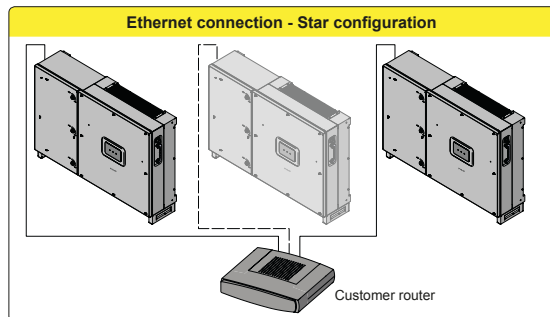
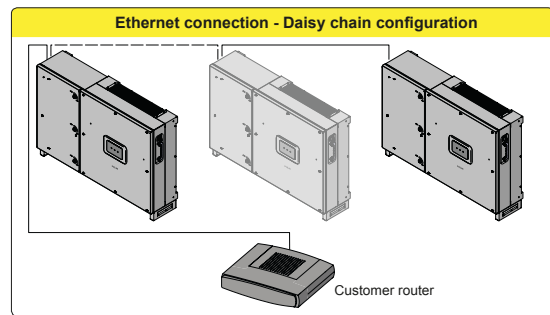

On each configuration of connection the maximum length of the cable must be 100m maximum between inverter – inverter and inverter – switch.



*For further information on the Ethernet connection refer to the Local Area Network standard IEEE802.3*

Please refer to Aurora Vision documents available on FIMER website for further information how to get an Aurora Vision account for remotely monitoring and managing the installed solar assets.



*No initial setup is required to start data transmission to Aurora Vision. Internet connection is required to use all the Aurora Vision remote functionalities.*



## Ethernet connection

The connection of the ethernet communication cable must be made on the specific connectors **65** located on the interposer board **50** (vertically positioned on the communication and control board **30**) inside the wiring box. If the inverters of the plant need to be connected in daisy chain or ring configuration use both connectors.

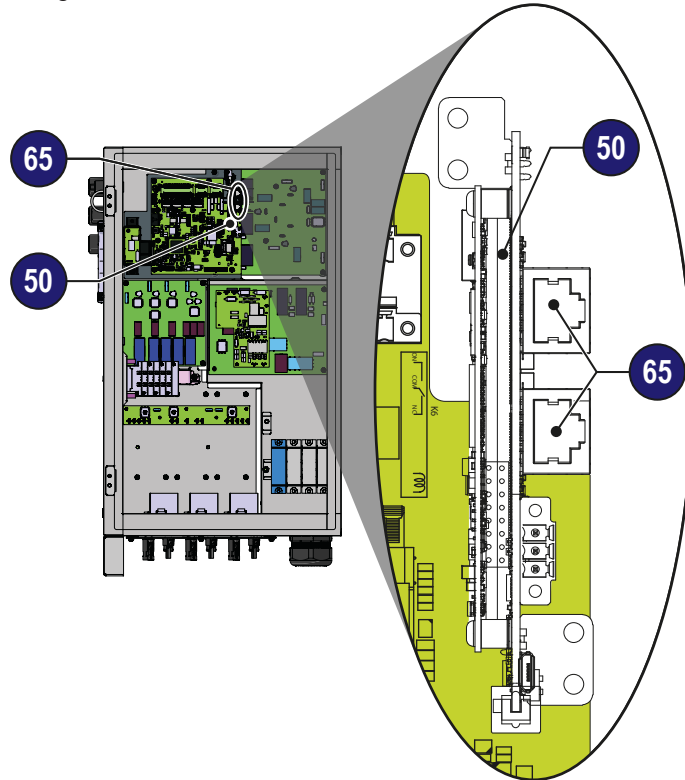

The cable should be compliant to the following specification:

- Cross-section: min. 2 x 2 x 0.22 mm<sup>2</sup> or min. 2 x 2 x AWG 24
- Cable type: 100BaseTx, CAT5 (or higher) with shielding STP or FTP
- UV-resistant if used outdoors
- Type of plug: metallic shielded RJ45
- The maximum length that can reach these cables is 100 meters, and it is always advisable not to let them pass by the power cords to avoid interference with data transmission.
- Maximum inverters number connected over one single daisy chain is 40

Procedure to install the counterpart on the cable:

1. Unscrew the holding ring nut from the connector; remove the the gasket inside the connector body; feed the ethernet cable through the holding ring nut and the connector body
2. Install the gasket on the cable
3. Push the gasket inside the connector body until it fits snugly
4. Extract the cable from the corresponding part just enough to enable the connection in the connector on the inverter.

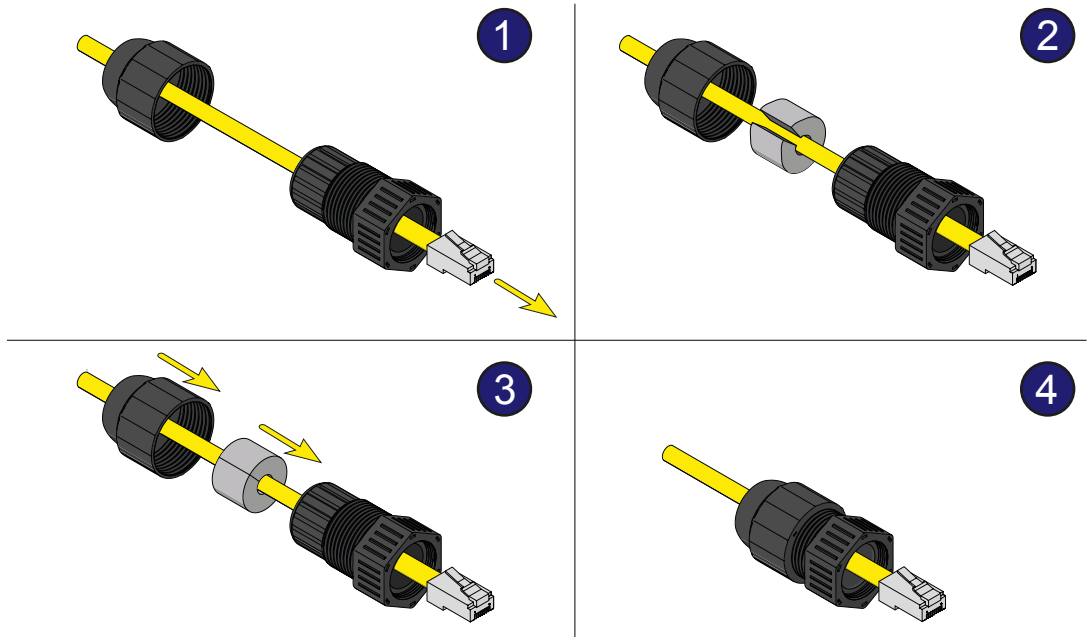

Proceed as follows to install the cable on the inverter:

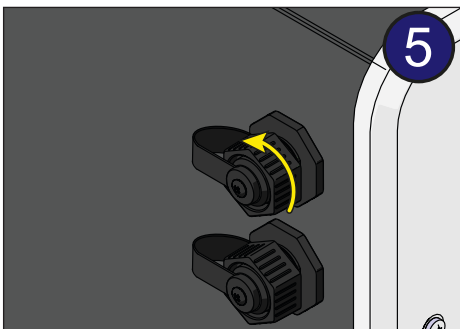

5. Remove the cap from the ethernet connector installed on the inverter.

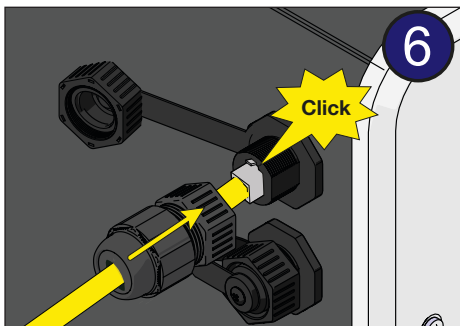

6. Connect the ethernet cable

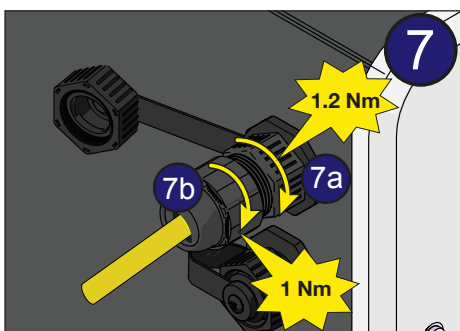

7. Slide the counterpart on the cable until bringing it snug to the ethernet connector of the inverter.

7a. Turn the fastening ring nut (tightening torque of 1.2 Nm / 0.9 ft-lb) until blocking the two connectors and check the correctness of the installation.

7b. Turn the holding ring nut (tightening torque 1.0 Nm / 0.7 ft-lb)

## Serial Communication connection - Slave (RS485-1, RS485-2)



Be advise that automatic settings of network parameters at the turning on, embedded logging capability, automatic logger free transferring of data to Aurora Vision Cloud and remote firmware update are provided over TCP/IP (Ethernet and/or Wi-fi) bus only.



The use of the inverters over the RS485 line is recommended in case of monitoring and controlling by using third party RS485 control systems.

The connection of the inverters over this RS485 line is recommended for replacement of already installed old model of inverters or service purpose only.

### - RS485-1 serial communication line.

The communication protocol can be set as “Aurora” (proprietary communication protocol) or Modbus RTU (FIMER protocol).

**This port must be used for firmware upgrading (locally or remotely through the FIMER monitoring devices)**



When connecting the FIMER monitoring devices, the RS485-1 line must be used

### - RS485-2 serial communication line.

The communication protocol can be set as “Aurora” (proprietary communication protocol), Modbus RTU (FIMER protocol) or Modbus RTU (Sunspec protocol).

Cables connecting the RS485 line may use two different types of connection:

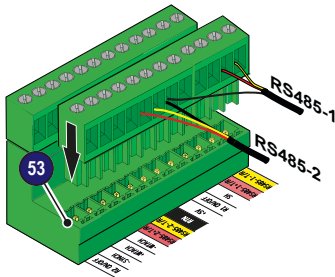

### • Connection of the conductors using the terminal connectors <sup>53</sup>

For long distance connections, the connection on terminal connector is preferable using a shielded twisted pair cable with characteristic impedance of  $Z_0=120$  Ohm like the one shown on the following table:

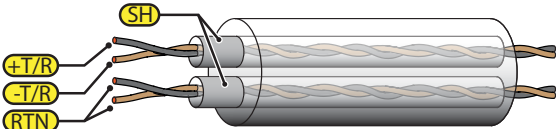
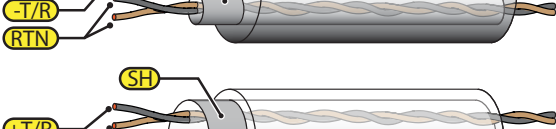
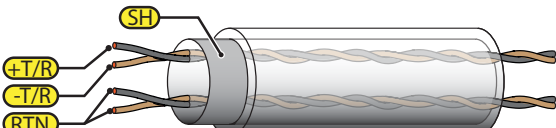
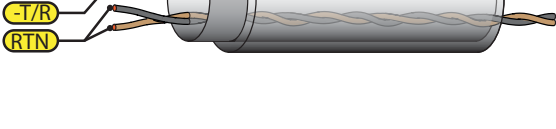
	Signal	Symbol
	Positive data	RS485 (-1 or -2) +T/R
	Negative data	RS485 (-1 or -2) -T/R
	Reference	RTN
	Screen	SH



Shield continuity must be provided along the communication line using the SH terminal and must be grounded at a single point.

The RS485 line can be used to set up a line of communication which, when connected to a monitoring device, enables the operation of the photovoltaic system to be kept under control. Depending on the device used monitoring can be local or remote.



For information on installation, compatibility and use please refer to the specific documentation on the accessory components.

- **Connection of conductors with RJ45 connectors 56 or 57**  
The two RJ45 connectors (A) and (B) available for the RS485 communication, are equivalent to each other and can be used interchangeably for the arrival or for the output of the line in realising the daisy chain connection of the inverters.

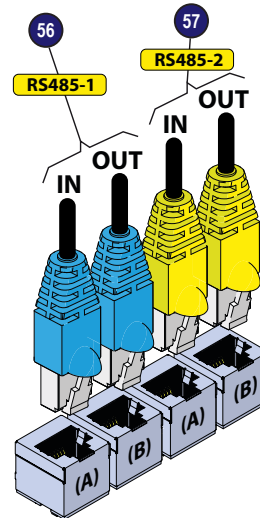

Table: crimping diagram for RJ45 connectors

	Pin No.	Function
	3	+T/R
	5	-T/R
	7	RTN
	1, 2, 4, 6, 8	not used



Use a connector with metal body to provide cable shield continuity!

For both type of connection, proceed to connect all the units of the RS485 chain in accordance with the daisy-chain model observing the correspondence between the signals, and activate the termination resistance of the communication line in the final element of the chain by switching:

- the 54 switch for the RS485-1 line in the ON position.
- the 58 switch for the RS485-2 line in the ON position.

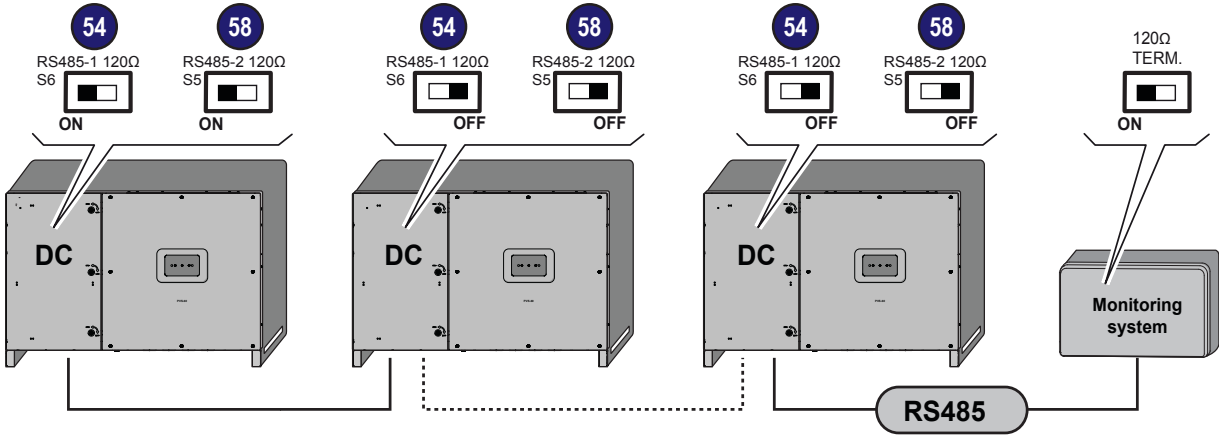

The communication line must also be terminated on the first element of the chain which normally corresponds to the monitoring device.



It is recommended not to exceed a length of 1000m for the communication line. The maximum number of inverters that can be connected to the same RS485 line is 62.

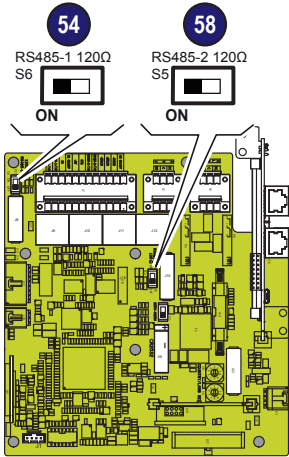

When connecting a single inverter to the monitoring system, activate the communication line resistance terminal by setting the switch 54 or 58 (to the ON position).

Set a different RS485 address on each inverter in the chain. **No inverter can have "Auto" as an address.** An address can be freely chosen between 2 and 63.

The setting of the address on the inverter is done through the "Aurora Manager" software.

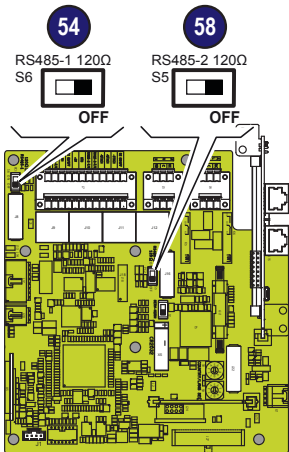

When an RS-485 connection is being used, if one or more inverters are added to the system at a later time, it is necessary to remember to reset to OFF the switch on the termination resistance being used (1) or (2) on the inverter which previously was the last in the system.

Each inverter is shipped with the RS485 address pre-set to two (2) and with the resistance terminal setting switch 54 or 58 in the OFF position.

## Serial Communication connection - Slave/Master (RS485-MAIN)

The RS485-MAIN terminal block **60** is located on the Interposer board **50**.

This port can be setted as:

- **Slave** (default setting). In this configuration the port allows to connect one device using Modbus RTU (FIMER protocol) or Modbus RTU (Sun-spec protocol) communication protocol.



*Is possible to connect only one device to the RS485-MAIN*

- **Master**. In this configuration the port is used for connecting supported accessories (like energy meter, VSN800 weather station, etc); in this case data from accessories will be logged and transferred to the cloud by inverter itself (master mode). To know how to connect the accessories to the RS485 terminal block refer to accessory product manual or contact FIMER customer support. When an accessory is connected to the RS485-MAIN port it must be added and configured into the “Device Acquisition” list on the integrated Web User Interface (refer to chapter “Web User Interface”).

In both the configurations the connection to the RS485-MAIN is made on the dedicated connector located on the Interposer board **50**.

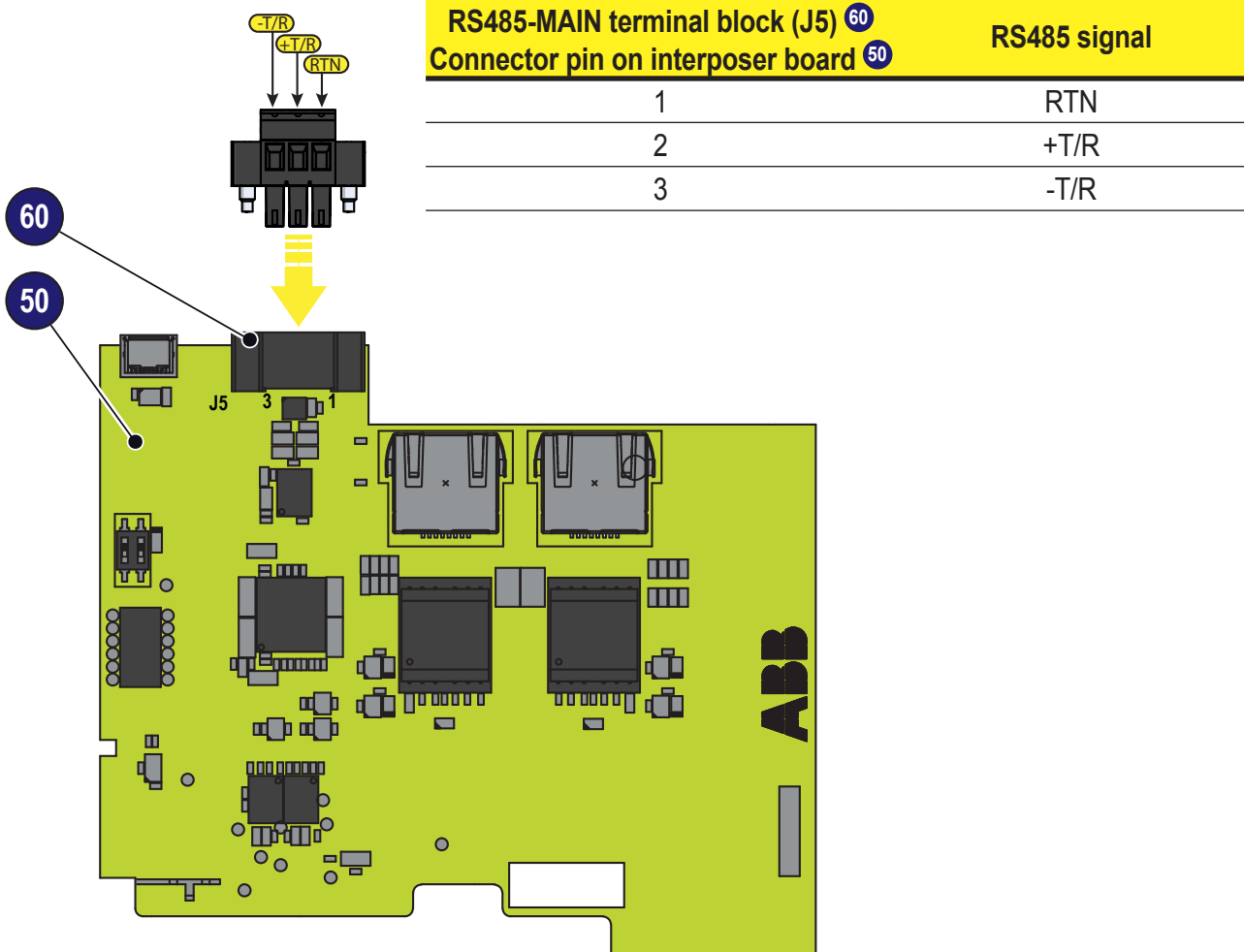

## Remote control connection

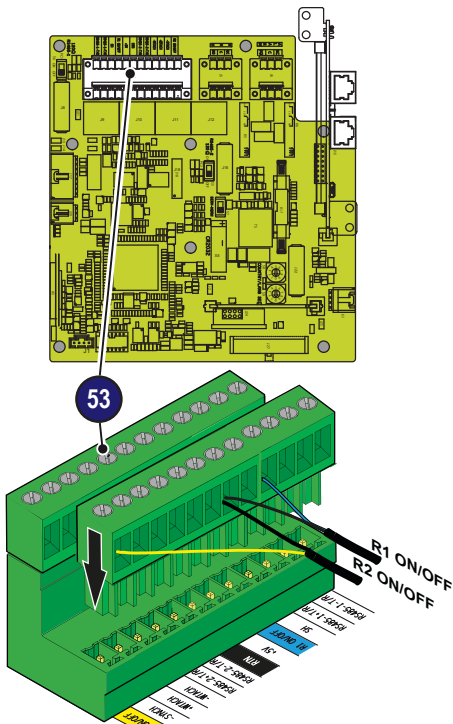

The connection and disconnection of the inverter to and from the grid can be controlled through an external control.

The function must be enabled in the relevant menu through the Aurora Manager Tools software. If the remote control function is disabled, the switching on of the inverter is dictated by the presence of the normal parameters which allow the inverter to connect to the grid.

If the remote control function is operating, besides being dictated by the presence of the normal parameters that allow the inverter to connect to the grid, the switching on of the inverter also depends on the state of the R1 ON/OFF and R2 ON/OFF terminals compared to the RTN terminal present on the a11 connector of the communication and control board 30.

When one of the R1 ON/OFF or R2 ON/OFF signals is brought to the same potential as the RTN signal (i.e. by making a short circuit between the two terminals of the connector), this causes the inverter to disconnect from the grid.

The connections of these controls are made between the "R1 ON/OFF" and the "R1 ON/OFF" inputs compared to the common "RTN" signal. Since this is a digital input, there are no requirements to be observed as regards cable cross-section (it only needs to comply with the sizing requirement for passing cables through the cable glands and the terminal connector).

## Configurable Relay connection (ALARM and AUX)

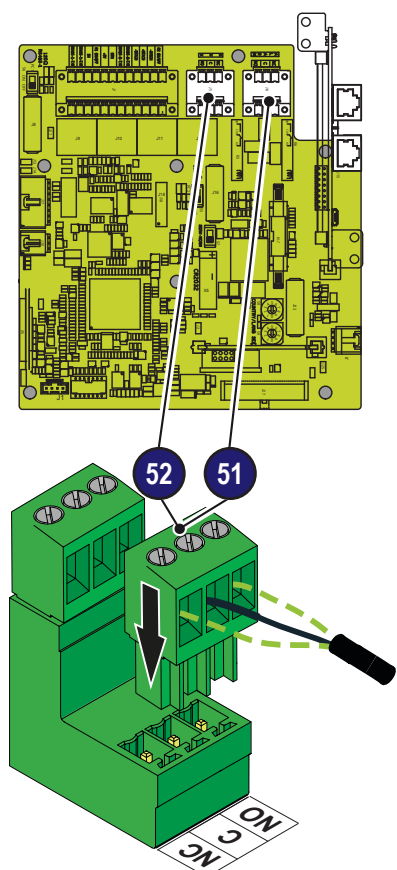

The inverter is equipped with 2 multifunction relays with configurable activation. It can be connected with normally open contact (being connected between the NO terminal and the common contact C) and with normally closed contact (being connected between the NC terminal and the common contact C).

Different types of devices (light, sound, etc.) can be connected to the relay, provided they comply with the following requirements:

### Alternating current

Maximum Voltage: 240 V AC

Maximum Current: 1 A

### Direct current

Maximum Voltage: 30 V DC

Maximum Current: 0.8 A

### Cable requirements

External diameter: from 5 to 17 mm

Conductor cross-section: from 0.14 to 1.5 mm<sup>2</sup>

This contact can be used in different operating configurations that can be selected by accessing the embedded web server.

## Front cover closure

After terminating the connection and configuration of the inverter and before commissioning, the inverter's front cover must be closed.

*It is necessary to ensure the correct closing of the cover to maintain the water ingress protection degree of the inverter*

- Carefully close the cover.
- Insert the key in the key lock 08
- Turn the key lock 08 in "LOCK"
- Repeat the operation for the other key lock 08

Commissioning of the inverter can be started once the cover have been closed

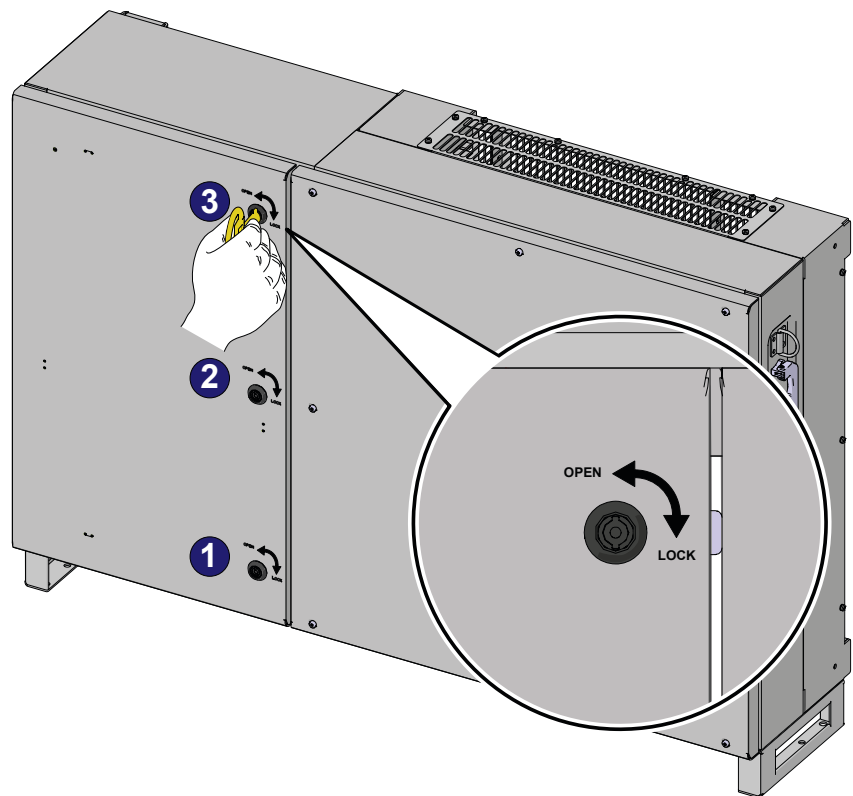



## General conditions

One of the first rules for preventing damage to the equipment and to the operator is to have a thorough knowledge of the instruments. We, therefore, advise that you carefully read this manual. If you are not sure about any information in this manual, please ask FIMER Service for more detailed information.



*Do not use the equipment if:*

- *you do not have suitable qualifications to work on this equipment or similar products;*
- *you are unable to understand how it works;*
- *you are not sure what will happen when the buttons or switches are operated;*
- *you notice any operating anomalies;*
- *there are doubts or contradictions between your experience, the manual and/or other operators.*

FIMER cannot be held responsible for damage to the equipment or the operator if it is the result of lack of knowledge, insufficient qualifications or lack of training.

## Overview of front panel LED functions

There are 3 front panel LEDs which provide information about the inverter.

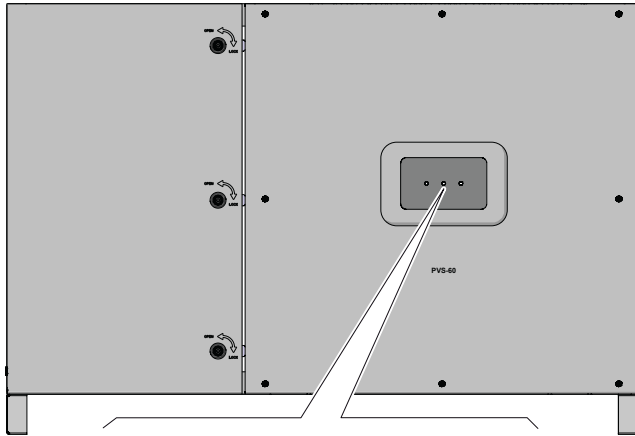

RED

The red “GFI” (aka ground fault or ground insulation fault) LED indicates that the inverter has detected a ground fault in the DC side photovoltaic array. The inverter immediately disconnects from the grid.

YELLOW

The yellow LED indicates that the inverter has detected an anomaly. Use the internal webserver to determine the nature of the warning.

GREEN

A solid green LED indicates that the inverter is functioning correctly.

When the unit is powered up, the green LED blinks while the grid is being checked. If a valid grid voltage is detected, the LED remains continuously lit, as long as there is sufficient sunlight to turn on the inverter. Otherwise, the green LED will continue to blink until the sunlight is sufficient for activation.

*The LEDs, in various combinations, signal additional conditions other than these single-LED scenarios. See the various descriptions explained in “LED behavior” paragraph (chapter 7).*

## Arc fault reset button

The red “GFI” LED indicates that the inverter has detected an arc fault in the DC side photovoltaic array.

If an arc fault occurs (red “GFI” LED turned on) the inverter immediately disconnects from the grid. It is possible to reset the alarm pushing the button on the left side of DC wiring box <sup>47</sup>. This button is present only in the -S and -SC versions:

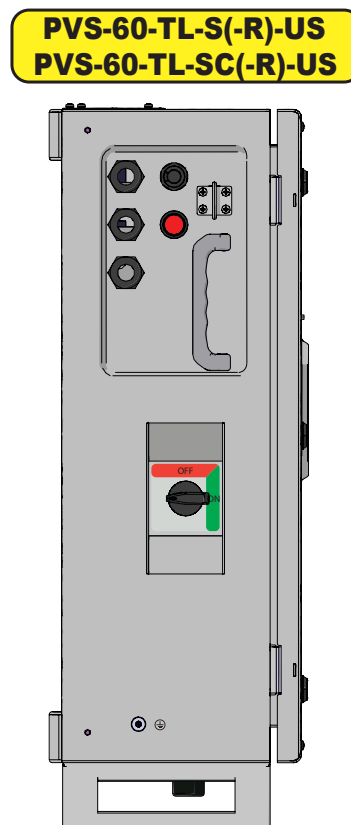

- If the inverter reconnects normally to the grid, the fault was due to temporary or intermittent conditions.  
If this malfunction occurs, have the PV plant inspected by a specialist. Arc faults are more likely in damp conditions, and signal an insulation breakdown.
- If the inverter does not reconnect to the grid, lock out/tag out both the AC and DC disconnects, then call for service to repair the fault in the photovoltaic array.

## User interface

### 1. FIMER Installer for Solar Inverters

- Mobile APP improving multiple inverter commissioning and system settings with FIMER Installer for Solar Inverters APP.
- Compatible with Android devices.
- Updating of the inverter firmware.

### 2. Embedded Web User Interface

- Accessible via Wi-Fi by using any WLAN enabled standard device (PC, smartphone, tabled,...)
- Enables single inverter commissioning and parameters settings.
- Updating the inverter firmware.

### 3. Aurora Vision Plant Management Platform

Additional to any local user interfaces the inverter comes with capability enabling remote monitoring and managing via Aurora Vision Plant Management Platform cloud. Aurora Vision offert includes:

- Plant Portfolio Manager: web portal for solar professional.
- Plant Viewer: single web page for casual user.
- Plant Viewer for Mobile: mobile application for plant monitoring.
- FIMER Ability™ for solar plants - Energy Viewer: mobile application for plant monitoring.
- Kiosk view: single HTML5 page for public visualization of plant data.
- API: web based tool for enabling the sharing of the data with a third party data.

## Measurement tolerance

The data supplied by the inverter may differ from measurements taken by certified measuring instruments (e.g. output meters, multimeters and grid analysers); since the inverter is not a measuring instrument it has wider tolerances for the measurements it makes.

The tolerances are generally:

±5% for real-time measurements with output power below 20%

±3% for real-time measurements with output power above 20%

±4% for all statistical data.

## General conditions

Before checking the operation of the equipment, it is necessary to have a thorough knowledge of the Instruments chapter 6 and the functions that have been enabled in the installation process.

The equipment operates automatically without the aid of an operator; the operating state should be controlled through the equipment's instrumentation.

*The interpretation or variation of some data is reserved exclusively for specialized and qualified staff.*



*The input voltage must not exceed the maximum values shown in the technical data, section 2 in order to avoid damaging the equipment. Consult the technical data for further details.*

During operation, check that the environmental and storage conditions are correct (see installation chapter 5).

Make sure that environmental and storage conditions have not changed over time and that the equipment is not exposed to adverse weather conditions.

## Commissioning



*Do not place objects of any kind on the inverter during operation! Do not touch the heat sink while the inverter is operating! Some parts may be very hot and could cause burns.*



*Before proceeding with commissioning, make sure you have carried out all the checks and verifications indicated in the section on preliminary checks.*



*Make sure irradiation is stable and adequate for the inverter commissioning procedure to be completed.*



*To address any problems that may occur during the initial stages of operation of the system and to ensure the inverter remains fully functional, you are advised to check for any firmware updates in the download area of the website [www.fimer.com](http://www.fimer.com) or at <https://registration.solar.fimer.com> (instructions for registering on the website and updating the firmware are given in this manual).*

Commissioning could be carried out in two different ways:

- **Via FIMER Installer for Solar Inverters APP**

Recommended mobile APP for commissioning single inverter as well as multi inverter solar plant.

- **Via Web UI (access point wireless network)**

Integrated Web User Interface enabling setting parameters and performing commissioning of a single inverter (multi inverter support is not provided).

Recommended as alternative method for performing single inverter commissioning.

## Commissioning via Installer for Solar Inverters mobile APP

“Installer for Solar Inverters” is the new advanced FIMER mobile APP allows to simplify commissioning, parameter settings and troubleshooting of FIMER string multi-inverters in large scale solar plants.

Even in case of single inverter installation it can be consider the most suitable professional tool to be used.

“Installer for Solar Inverters” mobile APP is available for mobile devices with an Android version of 6.0.1 or greather (iOS mobile devices support will come soon) and could be downloaded and installed from Play Store.

### Commissioning procedure:

It's highly recommended to connect the inverters in ethernet daisy chain (with or without ring) before executing the commissioning procedure.

Make sure that all the inverter being commissioned features the last firmware version (updating can be executed via Installer for Solar Inverters mobile APP).

- Close the DC disconnect switches **15** to supply the inverter with input voltage from the photovoltaic generator.



*Make sure irradiation is stable and adequate for the inverter commissioning procedure to be completed.*

**Log In To Aurora Vision®**

**i** In order to use this application you need your Aurora Vision® account.

---

User ID o

Please enter your credentials.

Password

By continuing, you agree to ABB's [Terms Of Service, Privacy Policy and Cookie use](#).

**Log In**

[Forgot your password?](#)

Don't have any account yet? [Sign Up](#)

The main steps to complete the commissioning procedures are listed below:

- Installer for Solar Inverters mobile APP installed on mobile device.
  - Enabled Aurora Vision installer account allowed to use the mobile APP
- The account can be created in the mobile APP directly following the dedicated wizard procedure.

- Manual claiming of the inverters to be commissioned.

The claiming process consists of indicating which inverters are to be commissioned.

Claiming process can be executed by scanning the QR codes of all the inverters being worked and putting the selected inverters into the working list. Please insert in the list inverters belonging to the same inverters family; no more than 40 inverters by time can be configured together.

As an alternative of QR code scanning, claiming process can be executed by selecting manually the SSIDs associated to the Wi-Fi networks generated by each inverter to commission and inserting Product key when requested.

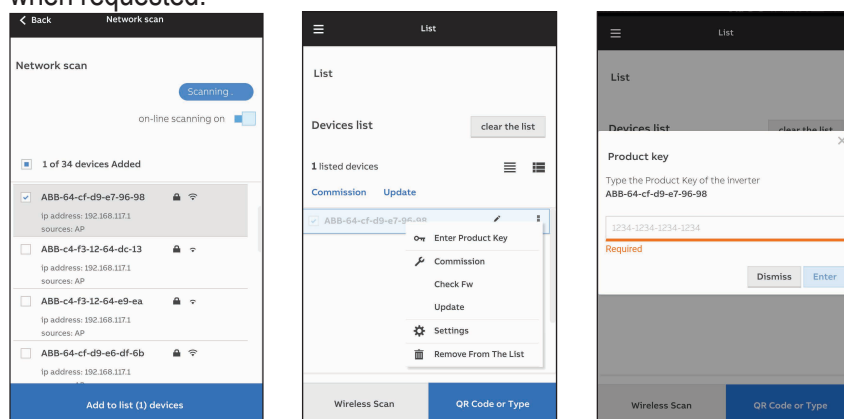

Both QR code and Product key are provided on the Communication identification label stuck onto each inverter.



*The Communication Identification label is divided in two separate parts by a dashed line; take the bottom part and apply it on the plant documentation. (it's recommend to create a plant map and apply the Communication Identification label of each inverters in the right position of that map).*

*Above steps are valid for executing any available functionalities of the Installer for Solar Inverters mobile APP.*

- In order to launch the installation wizard and so complete the commissioning procedure please click “Commissioning” button. If needed click prevently on “Firmware update” button for aligning the firmware of all the inverters in the list to the last version (internet connection is needed).
- Enter the IP Settings(DHCP or Static), Network SSID and password. Tap on “Connect” button to connect the inverter to the local wireless network. If the inverter should not be connected to a Local wireless network tap on “Skip this step” button (the inverter connection remains point-to-point).

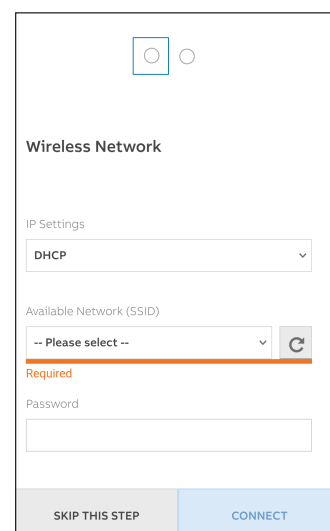
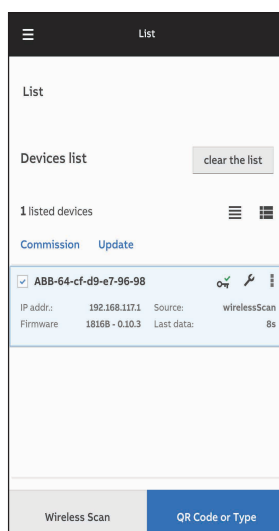



- Select the country standard and the configuration of the input channels. confirm the setting by clicking “DONE”.The image shows the successful commissioning.

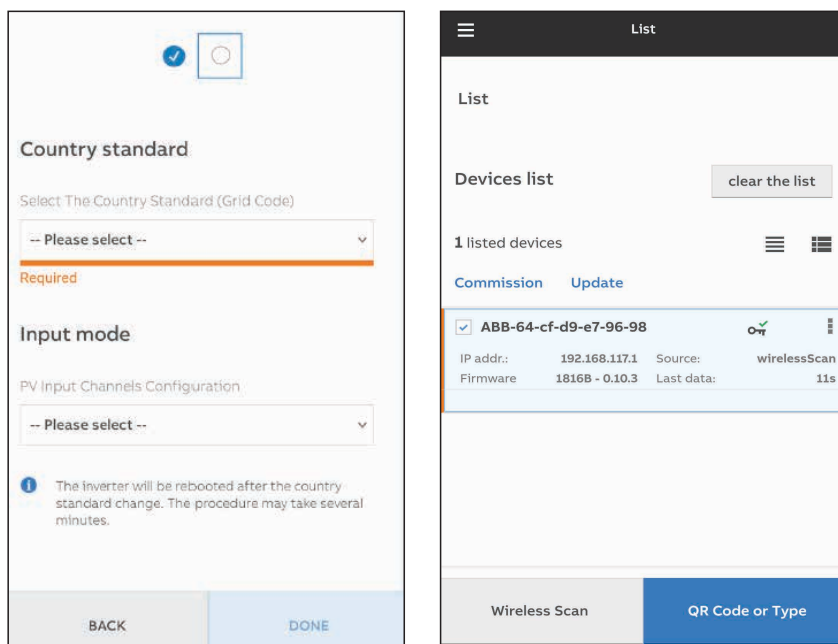

In the SETTING section it's possible to access the following sub-menus:

- RS485 (allows to set address, baud rate, parity mode and communication protocol)
- LAN (it's possible to view the status and change the daisy chain configuration of the two ethernet ports of the inverter.)
- WLAN (it's possible to view the status of the two wireless channels of the inverter, and to disconnect the channel 2.)
- Monitored Devices (it's possible to add and config the connected supported accessories to the RS485 In this case, modify the data on the RS485 tab according to the characteristics of the inserted device)



*For any other specific settings of parameters of single inverters please refer to “Description of the Web User Interface” chapter.*

After the commissioning via FIMER Installer for Solar Inverters APP is completed, the inverter changes the behaviour of the “Power” and “Alarm” LEDs <sup>08</sup>, in relation of the input voltage value:

Input voltage	LED Status	Description
$V_{in} < V_{start}$	Power = Flashing Alarm = OFF	The input voltage is not sufficient to enable connection to the grid.
$V_{in} > V_{start}$	Power = Flashing Alarm = ON	The input voltage is sufficient to enable connection to the grid: the inverter waits for the grid voltage to be present to make the connection to the grid.



*The inverter is powered SOLELY by the voltage generated by the photovoltaic generator: the presence of grid voltage alone is NOT SUFFICIENT for the inverter to switch on.*

- When the input voltage is sufficient to allow the connection to the grid, close the AC switch downstream of the inverter thus applying the grid voltage to the inverter: the inverter checks the grid voltage, measures the isolation resistance of the photovoltaic field with respect to ground and performs other auto-diagnostic checks. During the preliminary checks on the parallel connection with the grid, the “Power” LED keeps flashing, the “Alarm” and “GFI” LEDs are OFF.
- The inverter ONLY creates a parallel connection with the grid if the grid and isolation resistance parameters fall within the ranges foreseen by current regulations.
- If the outcome of the preliminary checks on the grid parallel is positive, the inverter connects to the grid and starts to export power to the grid. The “Power” LED remains fixed on while the “Alarm” and “GFI” LEDs are OFF.



*To address any problems that may occur during the initial stages of operation of the system and to ensure the inverter remains fully functional, you are advised to check for any firmware updates in the download area of the website [www.fimer.com](http://www.fimer.com) or at <https://registration.solar.fimer.com> (instructions for registering on the website and updating the firmware are given in this manual).*

## Commissioning Via Web UI - Wireless connection

### CONNECTION TO THE INVERTER - WIRELESS

Commissioning could be carried out via wireless connection to the inverter's Web User Interface. Initial setup of the system must therefore be carried out via a tablet, notebook or smartphone with a wireless connection.

- Close the DC disconnect switches **15** to supply the inverter with input voltage from the photovoltaic generator.



*Make sure irradiation is stable and adequate for the inverter commissioning procedure to be completed.*

- Once powered, the inverter will automatically create a wireless network (approx. 60 seconds after its switch-on).
- Enable the wireless connection on the device which is being used for the board setup (tablet, smartphone or PC) and connect it to the Access Point created by the inverter system: the name of the wireless network created by the system that the connection should be established with, will be: **ABB-XX-XX-XX-XX-XX-XX** where "X" is a hex digit of the wireless MAC address (MAC address can be found on the "Communication Identification Label" placed on the side of the inverter).



*The screens shown below pertain to a tablet with the Android operating system. Screens on other devices or operating systems may differ.*



- When required digit the **PRODUCT KEY** (printed on the "Communication Identification label" and applied during the commissioning phase to the plant documentation) as access point password.

**Note that it's required to digit also the dash "-" characters of the Product Key in the password field.**



*In case of need, product key can be recovered by Aurora Vision Cloud or by calling FIMER technical support.*

**COMMISSIONING PROCEDURE - WIRELESS CONNECTED**

- Open an internet browser (recommended browser: Chrome versions from v.55, Firefox versions from v.50, explorer is not compatible) and enter the pre-set IP address **192.168.117.1** to access the Web User Interface. Web User interface has easy commissioning wizard to commission the inverter.



*The language of the wizard could be changed by clicking on the upper status bar*



The required informations during the procedure are:

**STEP 1 - Administrator/User login credentials**

### Administrator account

Admin ⓘ

Username

Required

Password ⓘ

Password

Required

Confirm Password ⓘ

Re-enter Password

Required

### User account

User ⓘ

Username

Required

No user password

- Set the **Administrator** account user and password (minimum 8 character for password):  
Administrator account can open and view the contents of photovoltaic site. Additionally, they can make changes to inverter settings.  
User and password are CASE SENSITIVE.

- Set the **User** account user and (optional) password (minimum 8 character for password):  
User account can only read data. It cannot make any changes.  
User and password are CASE SENSITIVE.

**STEP 2 (Optional) - Wireless network connection.**

As described on chapter 2 the recommended way to get all the installed inverters to communicate to the internet and Aurora Vision Cloud is creating a cabled Ethernet daisy chain bus. Anyway, in case of a few inverters installation in suitable environment, it is also possible to connect each inverter of the plant to a Wi-Fi router without using any cable.

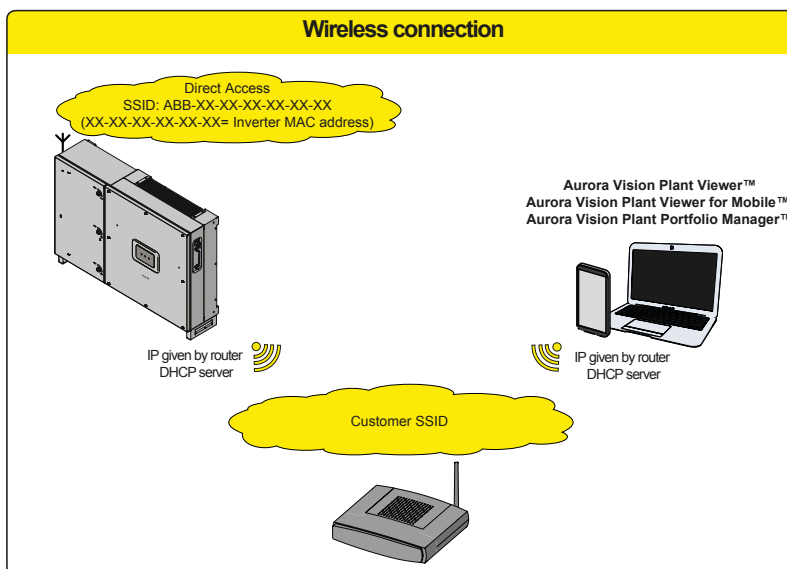

The AP is still available and the user can connect to the inverter.

In this scenario the Router gives IPs according to its own rules.

Inverter is reachable by IP.

Domain name can be used only if the Router permits multicast

During the installation wizard of the single inverter, the installer will be asked to connect the inverter to a Wi-Fi router. By selecting connection to Wi-Fi router the inverter will turn on a second Wi-Fi radio channel in order to enable connection to the Wi-Fi router. By selecting “Skip this step” button the other radio channel will be kept off.

Two Wi-Fi radio channels enables simultaneous wireless connection; one static IP address connection between inverter and installer devices and one between inverter and switch/router.

Whatever means is used to connect the inverter to the router (Ethernet cable or Wi-Fi) it will be always possible to access to the embedded web server also by connecting its own device to the same switch/ router, and reaching the inverter (via second radio channel in case of Wi-Fi connection with the router) by using the assigned IP address or inverter’s host name



*The IP address assigned to the inverter may vary or may be unknown. Please contact the IT administrator for getting the assigned IP address.*

*Differently from the assigned IP address, the «Host Name» of the inverter is unchangeable over time.*

*In order to use the «Host Name» as an alternative to the assigned IP address, for accessing to the inverters web server from the router the Domain Name System (DNS) service is needed to be available and activated.*

*The Host Name associated to each FIMER inverters is structured as indicated below:*

**FIMER-logger ID.LOCAL** where:

**logger ID** stands for the MAC address indicated on the “Communication identification lable” applied on the inverter.



The parameters relating to the customer wireless network (set on the router) that must be known and set during this step are:

- IP Settings: DHCP or Static.

If you select the DHCP function (default setup) the router will automatically assign a dynamic IP address to the inverter whenever it tries to connect to the user network.

With Static, the user can assign a fixed IP address to the system. The data which has to be entered in order for IP static address assigning to take place will appear. Complete the additional fields at the bottom of the screen (all the fields are mandatory with the exception of the secondary DNS server).

- Available networks (SSID):

Identify and select your own (customer) wireless network from all those shown in the SSID field (you can carry out a new search of the networks that can be detected with the Update button ).

Once the network has been selected, confirm.

- Password: Wireless network password.

Enter the password for the destination network (if necessary) and start the connection attempt (it will take a few seconds).

Click on “Connect” button to connect the inverter to the home wireless network.

A message will ask for confirmation. Click “Next” to connect the inverter to the customer wireless network.

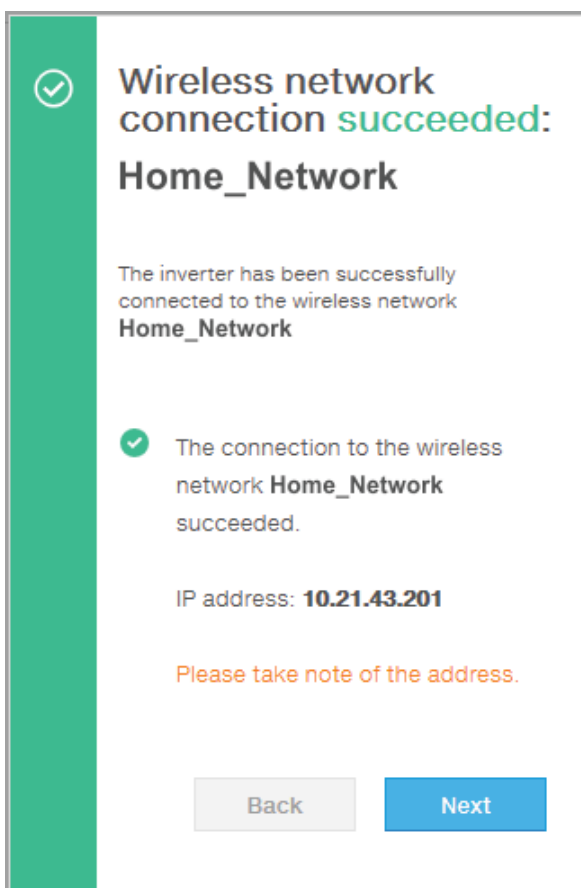

Once the inverter is connected to the customer wireless network, a new message will confirm that the connection is acquired.

The message provides the IP Address assigned by the home wireless network router to the inverter that can be used each time you want to access the Web User Interface, with the inverter connected to the home wireless network. **Take note of it.**

Click on “Next” button to proceed to the next stage of the configuration wizard.



*The IP address assigned may vary for reasons connected to the wireless home router setup (for example, a very brief DHCP lease time). If verification of the address is required, it is usually possible to obtain the client list (and the corresponding IP addresses) from the wireless router administration panel.*

If the inverter loses the connection with the home wireless network (and therefore, loses the internet connection), it will once again enable its own access point.



*The most common causes of losing connectivity might be: different wireless network password, faulty or unreachable router, replacement of router (different SSID) without the necessary setting updates.*

## STEP 3 - Date, Time and Time zone

### Date and Time

 Network Time Protocol server has been detected and it will be used to keep the system clock synchronized.

Date 

Feb 22, 2017

SET by the NTP server

Time 

3:28 PM

SET by the NTP server

Time Zone

Europe/Berlin GMT+01:00

BACK NEXT

Set the Date, Time and Time zone (The inverter will propose these fields when available).

### Date and Time

 Network Time Protocol server has not been detected. Clock isn't synchronized. The displayed date and time come from the inverter or have been manually set up.

Please set the correct system date and time if needed.

Date and time will be automatically updated as soon as an NTP server is available.

Date

2/8/17

Time

11 : 56 AM

Time Zone

Europe/Berlin GMT+01:00

BACK NEXT

When it's not possible for the inverter to detect the time protocol, these fields have to be manually entered.

Click on "Next" button to proceed to the next stage of the configuration wizard.



## STEP 4 - Inverter country standard and Input configuration

- **Country standard: selection of grid standard:**

Set the grid standard of the country in which the inverter is installed.



From the moment that the grid standard is set, you have 24 hours to make any changes to the value, after which the “Country Select > Set Std.” functionality is blocked, and the remaining time will have to be reset in order to have the 24 hours of operation available again in which to select a new grid standard (follow the procedure “Resetting the remaining time for grid standard variation” described in the relevant section).

### Country standard

Grid Standard

-- Please select --

Required

### Input mode

PV Input Channels Configuration

Independent

BACK

END

- **Input mode:**

(See the relevant section of this manual to know how set the input mode)

1. **Independent**
2. **Parallel**

Confirm the settings by clicking “END” and the inverter will reboot.

A notification will confirm that the wizard is completed.

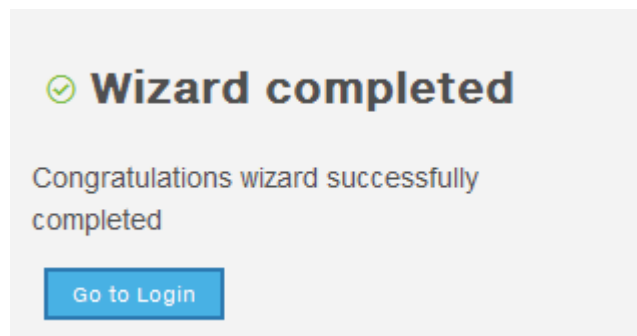

- After the wizard is completed the inverter changes the behaviour of the “Power” and “Alarm” LEDs <sup>05</sup> in relation of the input voltage value:

Input voltage	LED Status	Description
$V_{in} < V_{start}$	Power = Flashing Alarm = OFF	The input voltage is not sufficient to enable connection to the grid.
$V_{in} > V_{start}$	Power = Flashing Alarm = ON	The input voltage is sufficient to enable connection to the grid: the inverter waits for the grid voltage to be present to make the connection to the grid.



*The inverter is powered SOLELY by the voltage generated by the photovoltaic generator: the presence of grid voltage alone is NOT SUFFICIENT for the inverter to switch on.*

- When the input voltage is sufficient to allow the connection to the grid, close the AC switch downstream of the inverter thus applying the grid voltage to the inverter: the inverter checks the grid voltage, measures the isolation resistance of the photovoltaic field with respect to ground and performs other auto-diagnostic checks. During the preliminary checks on the parallel connection with the grid, the “Power” LED keeps flashing, the “Alarm” and “GFI” LEDs are OFF.
- The inverter ONLY creates a parallel connection with the grid if the grid and isolation resistance parameters fall within the ranges foreseen by current regulations.
- If the outcome of the preliminary checks on the grid parallel is positive, the inverter connects to the grid and starts to export power to the grid. The “Power” LED remains fixed on while the “Alarm” and “GFI” LEDs are OFF.



























*To address any problems that may occur during the initial stages of operation of the system and to ensure the inverter remains fully functional, you are advised to check for any firmware updates in the download area of the website [www.fimer.com](http://www.fimer.com) or at <https://registration.solar.fimer.com> (instructions for registering on the website and updating the firmware are given in this manual).*



















## LED behaviour

The LEDs on the front panel may behave in different ways depending on the inverter's operational status.

All possible LED activation combinations are shown in the following table. In particular, each LED could behave in one of the following ways:

- = LED on
- ⊗ = LED flashing slow (2 seconds on / 2 seconds off)
- ⊗ = LED flashing fast (0.2 seconds on / 0.2 seconds off)
- = LED off
- ⊗ = Any one of the conditions described above

LED status	Operating state
green:  yellow:  red: 	<b>Firmware programming</b> The inverter firmware is being programmed
green:  yellow:  red: 	<b>Night mode (inverter automatically switches off)</b> The inverter is in night time switch-off mode (input voltage less than 70% of the set start-up voltage).
green:  yellow:  red: 	<b>Inverter initialization</b> This is a transitional state due to verification of the operating conditions. During this stage the inverter checks that the conditions for connecting to the grid are met.
green:  yellow:  red: 	<b>The inverter is connected and is feeding power into the grid</b> Normal operation. During this stage, the inverter automatically tracks and analyses the photovoltaic generator's maximum power point (MPP).
green:  yellow:  red: 	<b>Disconnection from the grid</b> Indicates lack of grid voltage. This condition does not allow the inverter to connect to the grid (the inverter display shows the message "Missing Grid").
green:  yellow:  red: 	<b>Warning indication: (W message codes) or Error: (E message codes)</b> - Indicates that the inverter control system has detected a warning (W) or error (E). It is possible to identify the type of problem generated with the Aurora Manager LITE software (see the alarm messages).
green:  yellow:  red: 	<b>Temperature protection trip</b> Indicates that the trip relating to internal temperatures (insufficient or excessive temperature) may have been activated
green:  yellow:  red: 	<b>Anomaly in the insulation system of the photovoltaic generator</b> Indicates that a leakage to earth from the PV generator has been detected, causing the inverter to disconnect from the grid.

LED status	Operating state
	<ul style="list-style-type: none"> <li>• <b>Ventilation anomaly</b> Indicates an anomaly in the operation of the internal ventilation system that could limit output power at high ambient temperatures.</li> </ul>
green: 	
yellow: 	<ul style="list-style-type: none"> <li>• <b>Overvoltage surge arresters triggered</b> Indicates that any class II overvoltage surge arresters installed on the AC or DC side have been triggered</li> </ul>
red: 	<ul style="list-style-type: none"> <li>• <b>Autotest not executed (only for Italian network standards)</b> On the inverter was not performed the Autotest</li> </ul>
	<ul style="list-style-type: none"> <li>• <b>Internal statistics memory anomaly</b> Indicates an operating anomaly in the internal memory on which the inverter statistics are stored</li> </ul>
	<ul style="list-style-type: none"> <li>• <b>Buffer battery discharged</b> The buffer battery is low and the inverter does not maintain the time setting</li> </ul>
	<ul style="list-style-type: none"> <li>• <b>Initial configuration failure</b> The inverter is in locked state due to a failure in the initial configuration of the equipment, such as the standard network setting for the country of installation</li> </ul>
green: 	
yellow: 	<ul style="list-style-type: none"> <li>• <b>Self-test not carried out (for Italian grid standards only)</b> Self-test operation failure</li> </ul>
red: 	<ul style="list-style-type: none"> <li>• <b>Incompatibility of the device firmware versions</b> The firmware versions of the various devices comprising the equipment are incompatible and are being updated (this is an automatic operation)</li> </ul>
	<ul style="list-style-type: none"> <li>• <b>Temperature sensor anomaly detected</b></li> </ul>
green: 	
yellow: 	
red: 	<ul style="list-style-type: none"> <li>• <b>Updating the firmware from an SD card</b> The equipment firmware is being updated from an SD card</li> </ul>
* lighting of the LEDs in sequence	<ul style="list-style-type: none"> <li>• <b>Firmware programming failure</b> There has been a failure in programming the firmware, of one or more internal devices of the equipment, to the equipment from an SD card.</li> </ul>
green: 	
yellow: 	
red: 	<ul style="list-style-type: none"> <li>• <b>Updating the firmware from an SD card completed</b> The equipment firmware has been successfully updated from an SD card</li> </ul>
green: 	
yellow: 	
red: 	<ul style="list-style-type: none"> <li>• <b>Updating the firmware from an SD card has failed</b> The equipment firmware update from an SD card has failed</li> </ul>
*blink 3 times	
green: 	
yellow: 	
red: 	<ul style="list-style-type: none"> <li>• <b>Remote OFF activated</b> The Remote Off command has been activated. The unit will not connect to the network until the remote ON command has been activated</li> </ul>

## Grid support functions

The inverter is equipped with advanced grid support functionality that is useful to support reactive loads and also assist in reliable operation of the utility grid in the presence of a large number of distributed energy generation sources.

The internal Webserver (see “Description of the internal Webserver” paragraph) can be used to adjust grid parameters.

A Wi-Fi connection to the inverter is required to modify settings using the internal Webserver.

### 1. Voltage ride-through

This inverter provides parameters to respond to underfrequency and overfrequency events. If frequency excursions occur, the inverter is designed to continue operating normally for a specified delay. Beyond this programmed delay, the inverter disconnects from the grid in the event of an abnormal voltage condition.

### 2. Frequency ride-through

This inverter provides parameters to respond to underfrequency and overfrequency events. If frequency excursions occur, the inverter is designed to continue operating normally for a specified delay. Beyond this programmed delay, the inverter disconnects from the grid in the event of an abnormal voltage condition.

### 3. Reactive power control

The inverter provides several modes of operation for reactive power control and are described below:

- Disable: This is the default setting. Under this setting, the inverter exports with a power factor of 1.0.
- Fixed power factor control (Cos $\phi$  set): In this mode, the operator can set the output power factor to a fixed value. When enabled, a new value will be set in the inverter.
- Q Fixed (Q Set): Sets the reactive power to a fixed value. When enabled, a new value will be set in the inverter.
- Power factor as function of output power (Watt/Cos $\phi$  Settings: Cos $\phi$ (P)): In this mode, the inverter reduces the power factor (cos-phi) as a function of the output power at a given operating point. The 4 points of the default curve, where you can set the % of Pmax values and related cos-phi, can be modified using the internal Webserver. When enabled, the curve will be set in the inverter.
- Dynamic Volt/VAR control (Volt/VAr Settings: Q(V)): Under this mode, the level of reactive power exported by the inverter is a function of the operating grid voltage, also known as a Volt/VAR curve. The 4 points of the default curve, where you can set the % of Vnom values and related % of Smax, can be modified using the internal Webserver. When enabled, the curve will be set in the inverter.

#### 4. Active Power Control

This inverter offers several modes for active power reduction.

- Active Power Curtailment: Sets a new value of active power as % of Pmax. When enabled, a new value will be set in the inverter.
- CEI Average VGrid Derating (only italian grid standard): Sets, after a specific threshold, an active power derating based on the average of Vac on 10 minutes as per CEI-021 italian grid standard.
- Volt/Watt settings: P(V). Under this mode, the level of active power exported by the inverter is a function of the operating grid voltage, also known as a Volt/Watt curve. The 4 points of the default curve, where you can set the % of Vnom values and related % of Pmax, can be modified using the internal Webserver. When enabled, the curve will be set in the inverter.
- Frequency/Watt function (Frequency Control: P(f)): In this mode, the inverter limits the active power as a function of the grid frequency.

#### 5. Ramp controls

The inverter is designed to control the rate at which output power is increased, either at startup, or after a temporary low power condition on the PV array (such as fast shading). The following ramp controls are provided on this inverter.

- Normal ramp: The normal ramp defines the maximum rate at which the inverter can increase the output power under normal operation. The normal ramp control limits the fluctuations in the output power in order to prevent instabilities on the utility grid.
- Soft start: The soft-start ramp defines the maximum rate at which the inverter can increase the output power when the inverter is first starting up. This startup may occur on a daily basis or when the inverter restarts after an abnormal grid event has ended.

This inverter has been factory programmed to automatically disconnect from the utility distribution system in compliance with UL 1741 and IEEE 1547-2003 specifications. Default voltage and frequency trip limit and trip time settings to comply with these standards are shown in table below. The internal Webserver can be used to adjust Voltage and Frequency Trip Limit and Trip Time Parameters according to Grid requirements of installation country.

Condition	Utility source		Max. time (sec) <sup>2</sup> at 60Hz before cessation of current
	Voltage (V)	Frequency (Hz)	
A	< 0.50 Vnom (Fixed)	Rated (60Hz)	0.16 (default)(Adj. Set Points 0.16 to 50s)
B	0.50 Vnom ≤ V < 0.88 Vnom (Adj.)	Rated (60Hz)	2 (Default)(Adj. Set Points 0.16 to 100 sec)
C	1.10 Vnom < V < 1.2 Vnom (Adj.)	Rated (60Hz)	1 (Default)(Adj. Set Points 0.16 to 100 sec)
D	1.2 Vnom ≤ V(Fixed)	Rated (60Hz)	0.16 (Adj. 0.001 to 0.16s)
E	Rated	f > 60.5Hz (Default) (Adj. 60.1 to 66.0 Hz)	0.16 (Default) (Adj. Set Points 0.16 to 1000 sec)
F	Rated	f < 59.3 Hz (Default) (Adj. 50.0 to 59.9 Hz)	0.16 (Default) (Adj. Set Points 0.16 to 1000 sec)
G	Rated	f << 57.0 Hz (Default) (Adj. 50.0 to 59.9 Hz)	0.16 (Default) (Adj. Set Points 0.16 to 1000 sec)
H	Rated	f >> 63.0 Hz (Default) (Adj. 60.1 to 66.0 Hz)	0.16 (Default) (Adj. Set Points 0.16 to 1000 sec)
Reconnection 300s (Default) (Adjustable 20s to 1000s)			

## Description of the Web User Interface

The inverter is equipped with an advanced integrated Web User Interface and user interface that allow a full access to all configuration and commissioning parameters from any electronic device (laptop, tablet and smartphone).

### Access to the Web User Interface

To access to the Web User Interface is required to connect a device equipped with wireless connection (such as tablet, laptop or smartphone).

Depending on the connection method chosen during the inverter commissioning phase ("Station Mode" or "AP Mode") it's required to follow one of the two procedures described below:

#### Connection to the inverter in "Station Mode"

- Enable the wireless connection on the device (tablet, smartphone or laptop) and connect it to the same wireless network to which the inverter is connected.
- Open an internet browser (recommened browser: Chrome versions from v.55, Firefox versions from v.50) and enter the links (corresponding to the IP Address assigned by the router to the inverter, or the "Host Name") provided during the commissioning phase to access the login page.



*In order to use the "Host Name" as an alternative to the dynamic IP address, the Wi-Fi router to which the board is connected (when operating in "Station Mode") must provide the Domain Name System (DNS) service (contact the network administrator for further information regarding the presence or absence of the DNS service in the Wi-Fi router or how to enable it). In this way, even if the IP address assigned to the inverter should change over time, (dynamic IP), it will always be possible to use the same "Host Name" which will remain unchanged over time.*



*The IP address assigned may vary for reasons connected to the wireless home router setup (for example, a very brief DHCP lease time). If verification of the address is required, it is usually possible to obtain the client list (and the corresponding IP addresses) from the wireless router administration panel.*



*If the "Host Name" was lost, it could be obtained writing this url:*

**<http://ABB-XX-XX-XX-XX-XX-XX.local>**

*replacing the "X" with the hex digits of the MAC address of the inverter (it can be found on the "Communication Identification label" placed on the side of the inverter or applied during the commissioning phase to the plant documentation).*

## Connection to the inverter in “AP Mode”

- Enable the wireless connection on the device which is being used for the board setup (tablet, smartphone or PC) and connect it to the Access Point created by the inverter system: the name of the wireless network created by the system that the connection should be established with, will be:

### **ABB-XX-XX-XX-XX-XX-XX**

where “X” is a hex digit of the MAC address (MAC address can be found on the “Communication Identification label” placed on the side of the inverter or applied during the commissioning phase to the plant documentation).

- When required digit the **PRODUCT KEY** (printed on the “Communication Identification label” and applied during the commissioning phase to the plant documentation) as access point password.

**Note that it’s required to digit also the dash “-” characters of the Product Key in the password field.**



*In case of need, product key can be recovered by Aurora Vision Cloud or by calling FIMER technical support.*

- Open an internet browser (reccomended browser: Chrome versions from v.55, Firefox versions from v.50) and enter the pre-set IP address **192.168.117.1** to access the login page.



## Login page

After you have connected the device to the inverter and you access to the login page, login with the username and password created during the commissioning phase.

**Log In**

*i* No user logged-in

Username

Password

**Log In**

[Forgot your password?](#)



*User and password are CASE SENSITIVE.*



*If the Password is lost click on “Forgot your password?” to obtain the access to the Web User Interface (and it will be possible to change the password) by entering the PRODUCT KEY (printed on the “Communication Identification label” and applied during the commissioning phase to the plant documentation).*



*The language of the Web User Interface could be changed in any moment by clicking on the right status bar:*

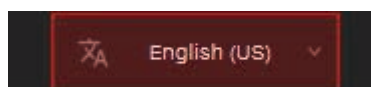

## Web User Interface menu structure



The following screenshots are related from a laptop visualization, may differ from smartphone or tablet visualization.

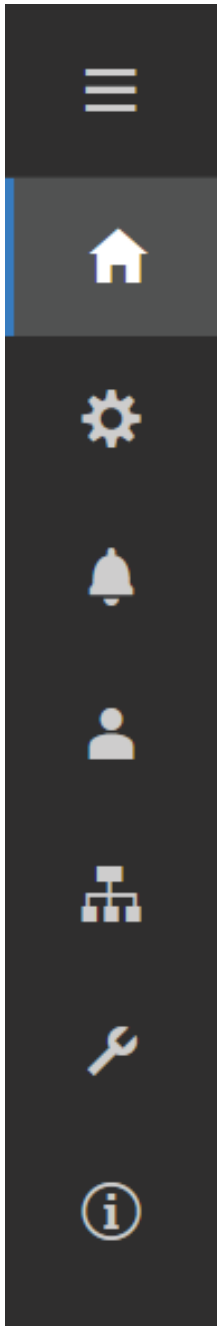

The Web User Interface is divided in six main sections, available on the left sidebar:

**MAIN:** Main section of Web User Interface dedicated to viewing the summary informations related the status and the production informations of the inverter and photovoltaic plant.

**SETTING:** Section dedicated to AC and DC line parameters configurations.

**INVERTER LOG:** Section dedicated to viewing Alarms and Warnings event log.

**USER:** Section dedicated to User management.

**NETWORK SERVICES:** Section dedicated to inverter communication settings and configurations.

**SERVICE TOOLS:** Section dedicated to main service tools configurations.

**INFORMATION:** Section dedicated for general informations about the embedded Web User Interface.



## MAIN section

In the **MAIN** section it's possible to access the following sub-menus:

- **Dashboard**
- **Status Summary**

### Dashboard

In the **Dashboard** sub-menu you can view the main informations related the status and the production informations of the inverter and photovoltaic plant and alarm/warning active events.

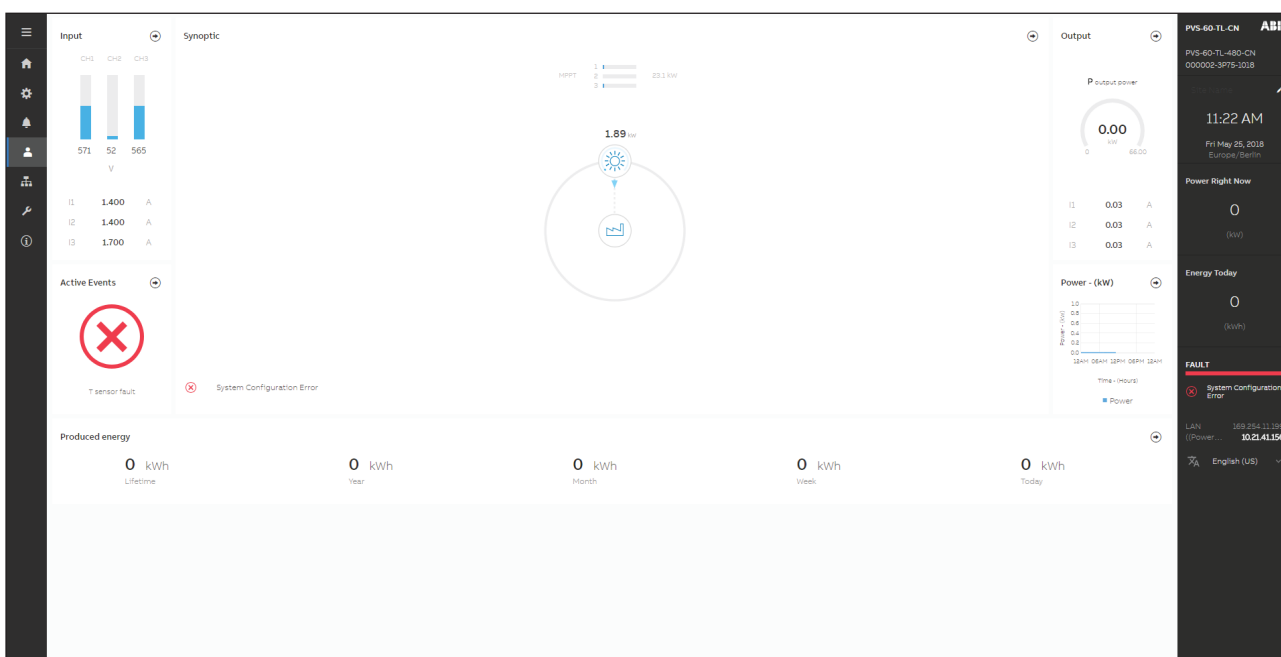

### Status Summary

In the **Status Summary** sub-menu you can view the detailed informations related the status and the production informations of the system.

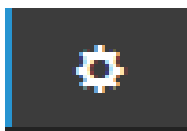

## SETTING section

In the **SETUP** section it's possible to access the following sub-menus:

- **AC output Rating** (*Only visible with Admin Plus privileges*)
- **AC Settings** (*Only visible with Admin Plus privileges*)
- **Active Power Control** (*Only visible with Admin Plus privileges*)
- **DC Settings**
- **Digital Inputs**
- **Frequency Control: P(f)** (*Only visible with Admin Plus privileges*)
- **Ramp Control** (*Only visible with Admin Plus privileges*)
- **Reactive Power Control** (*Only visible with Admin Plus privileges*)

### AC output Rating (Only visible and editable with Admin Plus privileges)

In the **AC output Rating** sub-menu you can config the output power limitation by changing the Maximum AC output power and the maximum apparent output power parameters.



*Do not change these parameters if not requested by the grid operator.*

### AC Settings (Only visible and editable with Admin Plus privileges)

In the **AC Settings** sub-menu you can setup the parameter related to the Output AC side:



*Changing the above-mentioned parameters may prevent disconnection from the grid if the new values exceed those given in the standards of the country of installation. If these parameters are changed to values outside the standard range, an interface protection must be installed external to the inverter in accordance with the requirements of the country of installation.*

#### 1. Grid Connection

By editing these settings it's possible to change the grid connection thresholds parameters to which the inverter have to connect to the grid

#### 2. Grid Protections + VRT/FRT

By editing these settings it's possible to enable/disable and change the grid protection intervention thresholds parameters. In addition it is possible to change voltage ride through (HVRT, LVRT) and frequency ride through (HFRT, LFRT) settings.

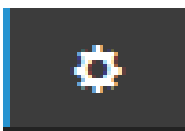

### **Active Power Control (Only visible and editable with Admin Plus privileges)**

In the **Active Power Control** sub-menu you can config settings related to the active power derating parameters using the following parameters groups:

1. **Active Power Curtailment**
2. **CEI Average VGrid Derating**
3. **Volt/Watt settings: P(V)**



*Do not change these parameters if not requested by the grid operator.*

### **DC Settings**

In the **DC Settings** sub-menu you can setup the parameter related to the Input DC side:

#### **1. VStart 1 New Value**

This parameter is used to sets the Vstart activation voltage for the input channel 1. This voltage imposes a minimum input voltage on the inverter above which connection to the grid will be attempted.

#### **2. VStart 2 New Value**

This parameter is used to sets the Vstart activation voltage for the input channel 2. This voltage imposes a minimum input voltage on the inverter above which connection to the grid will be attempted.

#### **3. VStart 3 New Value**

This parameter is used to sets the Vstart activation voltage for the input channel 3. This voltage imposes a minimum input voltage on the inverter above which connection to the grid will be attempted.



*Change the activation voltage only if really necessary and to set it to the correct value: the photovoltaic generator sizing tool available on the FIMER website will indicate whether Vstart needs to be changed and what value have to be set.*

#### **4. Input Mode - Independ / Parallel**

This settings allows you to sets the input configuration mode.

#### **5. UV Protection Time**

This section of the menu allows you to sets the time for which the inverter stays connected to the grid after the input voltage has dropped below the Under Voltage limit (set at 70% of Vstart).

(60 seconds is the default setting).

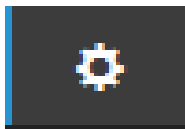

### 6. Multiple Max Scan Enable

This settings allows you to Enables/disables the scan for identifying the maximum power point of the system.

### 7. Multiple Max Scan Period

This settings allows you to sets the time between scans. Remember that the shorter the scan interval the greater the loss of production, due to the fact that energy is transferred to the grid during the scan but not at the maximum power point. Each scan takes roughly 2 seconds.

## Digital Inputs

In the **Digital Inputs** sub-menu you can disable or enable the Remote ON/OFF functionality related to the “Remote” terminal block <sup>53</sup>.

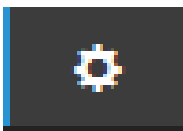

### **Frequency Control: P(f) (Only visible and editable with Admin Plus privileges)**

In the **Frequency Control: P(f)** sub-menu you can config settings related to the active power derating as function of grid frequency.



*Do not change these parameters if not requested by the grid operator.*

### **Ramp Control (Only visible and editable with Admin Plus privileges)**

In the **Ramp Control** sub-menu you can config the parameter related to the active power ramp up at the start-up and after a grid fault event.



*Do not change these parameters if not requested by the grid operator.*

### **Reactive Power Control (Only visible and editable with Admin Plus privileges)**

In the **Reactive Power Control** sub-menu you can configure settings related the reactive power parameters using the following parameters groups:

1. **Watt/Cosphi Settings: Cosphi(P)**
2. **Q Set**
3. **Cosphi Set**
4. **Volt/VAr Settings: Q(V)**



*Do not change these parameters if not requested by the grid operator.*

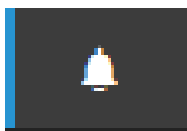

## Inverter Log

In the **Inverter Log** Section it's possible to view the Alarm and Warning events list that it can be custom filtered by type or by entering a matching word.

Clicking on any event to view his details.

The screenshot displays the 'Inverter Log' interface. At the top, there is a search bar labeled 'Filter' and two date pickers showing '2018-04-25' and '2018-05-25'. Below these are buttons for 'CLEAR FILTERS' and 'REFRESH EVENTS'. A tabbed interface shows 'ALL' selected, with other tabs for 'EVENTS', 'UPDATES', and 'CHANGES'. A pagination bar indicates '1 of 42' events. The main content area lists several error events, each with a red circle icon, the code 'E080 error', and the description 'T SENSOR FAULT'. The events are timestamped with dates and times from May 25, 2018.

Event ID	Device	Timestamp	Event Type	Description
000002-3P75-1018	supervisor	May 25, 2018 11:22:01 AM	E080 error	T SENSOR FAULT
000002-3P75-1018	supervisor	May 25, 2018 11:11:06 AM	E080 error	T SENSOR FAULT
000002-3P75-1018	supervisor	May 25, 2018 11:00:10 AM	E080 error	T SENSOR FAULT
000002-3P75-1018	supervisor	May 25, 2018 10:49:14 AM	E080 error	T SENSOR FAULT
000002-3P75-1018	supervisor	May 25, 2018 10:38:19 AM	E080 error	T SENSOR FAULT
000002-3P75-1018	supervisor	May 25, 2018 10:27:23 AM	E080 error	T SENSOR FAULT
000002-3P75-1018	supervisor	May 25, 2018 10:16:28 AM	E080 error	T SENSOR FAULT



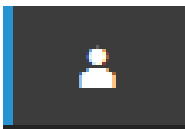

## USER section

In the **USER** section it's possible to logout from Web User Interface and return to the login page, or to access the following sub-menus:

- **Edit Email and Password**
- **Admin Plus**
- **User Management**

### Edit Email and Password

In the **Edit Email and Password** sub-menu you can change the e-mail and password related to the user which is used to login to the Web User Interface:

### Admin Plus

By accessing to the **Admin Plus** sub-menu you can obtain the “Admin Plus” user privileges which allow you to:

- Change the grid standard of the inverter, after 24 hours while the inverter is operating ( so the **Country Standard** sub-menu on **TOOLS** section is locked).
- View and edit the **AC Settings, Reactive Power Control, Ramp Control, Active Power Control** and **Frequency Control: P(f)**
- View and edit the “**MPPT Noise amplitude**” field in **DC Settings** on **SETUP** section.

To access on the Web User Interface with the “Admin Plus” user privileges it's required to enter a security token that can be obtained by registering on the website <https://registration.solar.fimer.com>. Refer to the dedicated section on this topic in the manual.

### User Management

By accessing to the **User Management** sub-menu it's possible to edit all the users already created and create new users (both with admin or User privileges).

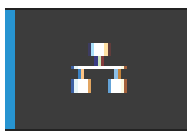

## NETWORK Services

In the **NETWORK Services** section it's possible to access the following sub-menus:

- **RS485**
- **LAN**
- **WLAN**
- **Modbus**
- **Connectivity Check**
- **Debug Settings**

### RS485

In the **RS485** sub-menu it's possible to adjust the settings relating to the RS485 communication serial line:

- RS485 Node Address: It allows you to sets the address for serial communication of the individual inverters connected to the RS485 line. The UP and DOWN buttons scroll through the numerical scale. (The addresses that can be assigned are 2 to 63).
- RS485 Baud Rate: It allows you to sets the Baud Rate (2400/4800/9600/19200/38400/57600/115200).
- RS485 Parity Mode: It allows you to set the Parity bit (No Parity, Even Parity, Odd Parity).
- RS485 Protocol Type: It allows you to sets the type of protocol to be used for the RS485 line.
  - "Modbus Sunspec Server": General purpose communication protocol to be selected to enable monitoring and control.
  - "Device Acquisition": Communication protocol to be used in case of connection in "Master" mode to external devices (like VSN800 weather station).



## LAN

In the **LAN** sub-menu it's possible to view the status and change the daisy chain configuration of the two ethernet ports of the inverter.

### - Daisy chain configuration: DHCP or Static:

By selecting the DHCP function (default setup) the router will automatically assign a dynamic IP address to the inverter whenever it tries to connect to the user network.

With Static, the user can assign a fixed IP address to the system. The data which has to be entered in order for IP static address assigning to take place will appear. Complete the additional fields at the bottom of the screen (all the fields are mandatory with the exception of the secondary DNS server).

### LAN Status

#### Daisy Chain

Linked interfaces:	<b>ETH0, ETH1</b>
IP Address:	10.21.39.51
Subnet Mask:	255.255.252.0
Gateway:	10.21.36.1
Primary DNS:	
Secondary DNS:	

#### Daisy chain configuration:

IP Settings

DHCP ▼

Back
Apply changes

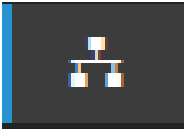

## WLAN

In the **WLAN** sub-menu it's possible to view the status of the two wireless channels of the inverter, and to disconnect the channel 2.

- Channel 1: "Access Point mode": Only local communication is enabled in this mode; In particular, the WLAN acts like an «access point» generating a wireless network to which the user can connect locally, configure the inverter / photovoltaic system, using the direct access to the embedded Web User Interface

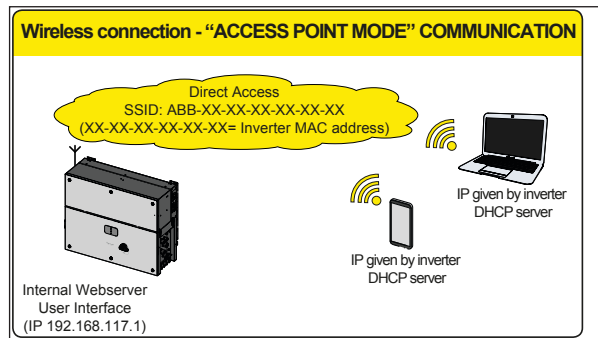

- Channel 2 "Station Mode": In this operating mode is possible to connect the inverter to a WI-Fi router; in this condition remote monitoring is enabled accessing to Aurora Vision® CLOUD platform.

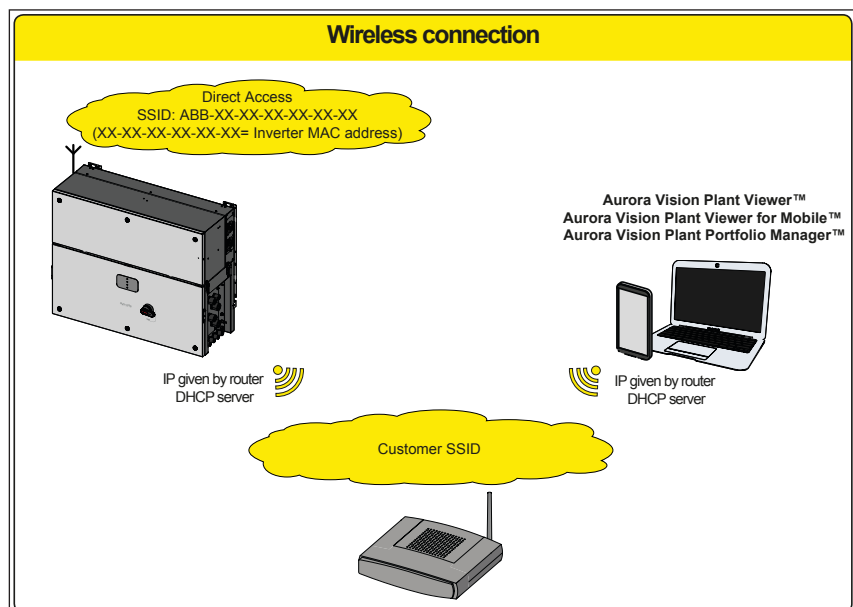

In case of connection to channel 2 (“Station Mode”), it will be required to enter the wireless network parameters (set on the router) and follow the subsequent procedure:

### WLAN Status

#### Wireless channel 1

Mode: Access Point  
 Status: **on**  
 SSID: ABB-b0-72-bf-9f-0d-39  
 IP: 192.168.117.1

#### Wireless channel 2

**You are connected through the channel 2 (Station)**

Mode: Station  
 Status: **connected**  
 Connected to: ((Power-One\_Internal))  
 Signal level: Strong  
 IP: 10.21.43.188

Netmask: 255.255.252.0  
 DNS:  
 Gateway: it-r-valwificli

**i** Connect through the AP channel to change the connection status or the configuration of the station channel

**DISCONNECT**

#### Edit channel 2 configuration

IP Settings

DHCP

Available Network (SSID)

((Power-One\_Internal)) **↻**

Password

password

Show password

**Back** **Switch to AP**

- IP Selection Mode: DHCP or Static:

By selecting the DHCP function (default setup) the router will automatically assign a dynamic IP address to the inverter whenever it tries to connect to the user network.

With Static, the user can assign a fixed IP address to the system. The data which has to be entered in order for IP static address assigning to take place will appear. Complete the additional fields at the bottom of the screen (all the fields are mandatory with the exception of the secondary DNS server).

- SSID (name of wireless network):

Identify and select your own (home) wireless network from all those shown in the SSID field (you can carry out a new search of the networks that can be detected with the Update button **↻**). Once the network has been selected, confirm.

- Password (wireless network password):

Enter the password for the destination network (if necessary) and start the connection attempt (it will take a few seconds).

Click on “Connect”

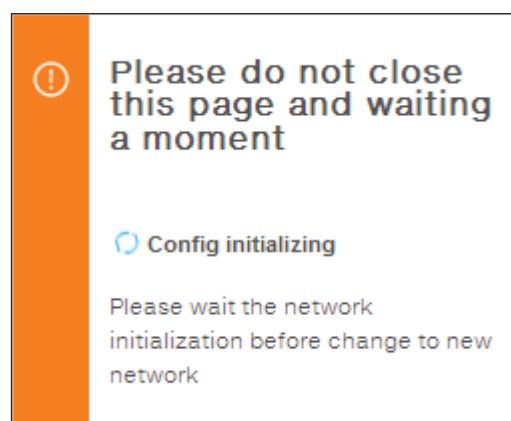

Once the inverter is associated with a wireless network, the user must switch the tablet/smartphone/PC to the same wireless network which the inverter is connected.

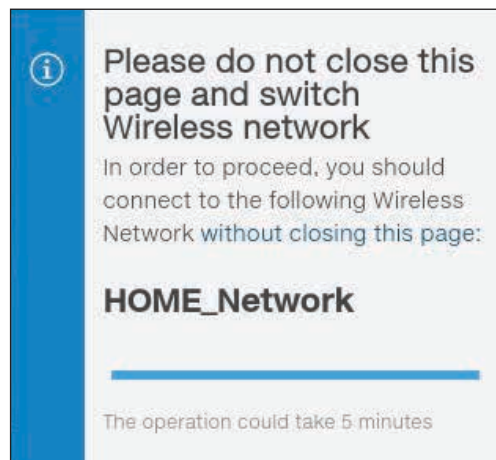

Once the tablet/smartphone/PC device is switched to the local wireless network a new message will confirm that the connection is acquired.

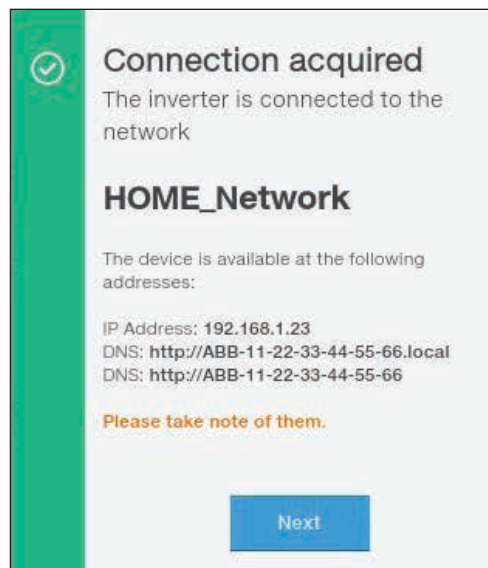

Click the “Next” button” to complete the setup of “Station Mode”



*In order to use the “Host Name” as an alternative to the dynamic IP address, the Wi-Fi router to which the board is connected (when operating in “Station Mode”) must provide the Domain Name System (DNS) service (contact the network administrator for further information regarding the presence or absence of the DNS service in the Wi-Fi router or how to enable it). In this way, even if the IP address assigned to the inverter should change over time, (dynamic IP), it will always be possible to use the same “Host Name” which will remain unchanged over time.*



*The IP address assigned may vary for reasons connected to the wireless home router setup (for example, a very brief DHCP lease time). If verification of the address is required, it is usually possible to obtain the client list (and the corresponding IP addresses) from the wireless router administration panel.*



## Modbus

In the **Modbus** submenu it is possible to set the RTU inverter communication mode (RS485):

- type the “Edit” key and select the type of external device
- According to the device, select the communication protocol of the inverter

Moreover in the TCP / IP (WLAN / LAN) section there are different settings based on the type of external device connected to the inverter.

- If the inverter acts as CLIENT and the external device as SERVER:
  - type the “Edit” key and select the type of external device
  - According to the device, select the communication protocol
  - type in the [+] key and the added device is displayed
  - change the STATE / SLAVE ID / NAME / IP ADDRESS / PORT / DEVICE settings and save them.
- If the inverter acts as a SERVER, set the port communication protocol only (Communication protocol server)

Setting up communication over TCP/IP

[Edit WLAN](#)  
[Edit LAN](#)

Communication protocol Server Sunspecs Protocol

Enabling monitoring of devices connected over Local Area Network

Used port

Add device -- Please select --

STATE	SLAVE ID	NAME	IP ADDRESS	PORT	DEVICE
<input type="button" value="Edit"/>					

---

Setting up communication over Serial Ports

RS485 Main - Node Address 1, Modbus SunSpec Server, 19200 bps, No Parity [Edit RS485](#)

Enabling monitoring of devices connected over Serial Ports

Operating mode Modbus SunSpec Server

To add a device you should switch to device acquisition operating mode

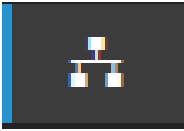

## Connectivity Check

In the **Connectivity Check** sub-menu it's possible to carry out connectivity tests of the wireless network connection, ethernet connection, connection to Aurora Vision and firmware upgrade servers.

At the end of the test it will be reported the detail of the results.

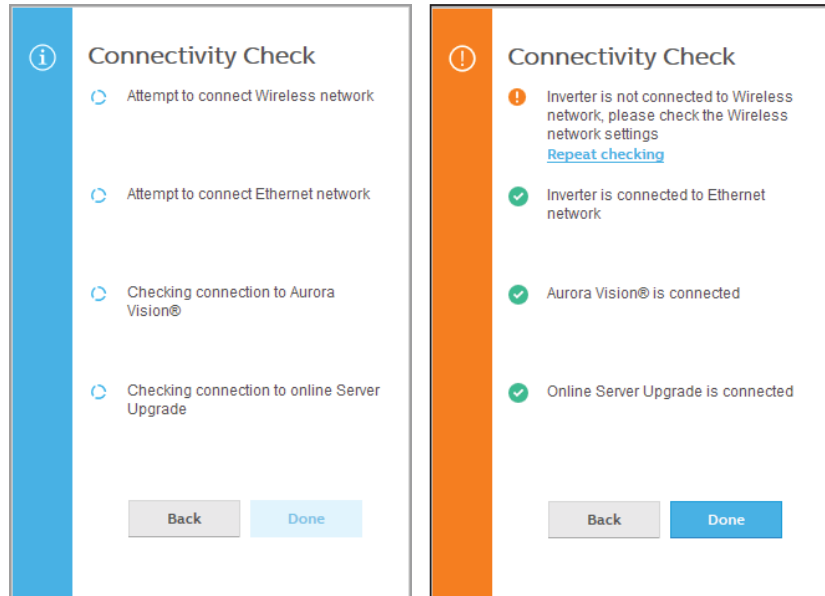

## Debug Settings

In the **Debug Settings** sub-menu it's possible to enable or disable the Debugging access for FIMER Service purposes.





# Service TOOLS

In the **Service TOOLS** section it's possible to access the following sub-menus:

- **Digital Output management**
- **Country Standard**
- **Firmware Update**
- **Date/Time**
- **Reset Manufacturing** *(Only visible with Admin Plus privileges)*

## Digital Output Management

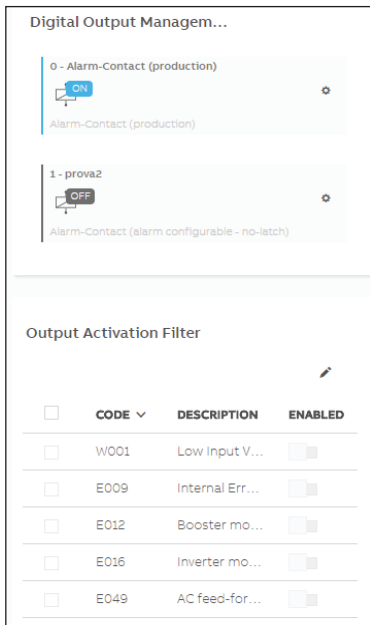

This section of the menu allows you to set the activation status of a relay (available either as contact normally open – N.O. - and as a normally closed contact -N.C.) and to configure customised alarm conditions.

This contact can be used, for example, to: activate a siren or a visual alarm, control the disconnect device of an external transformer, or control an external device. A little description of the alarm type (e.g. “alarm lamp”) is required.

Relay switching can be set in different modes using the setting icon :

With “Output active filter” you can select the list of events for which the relays switch.

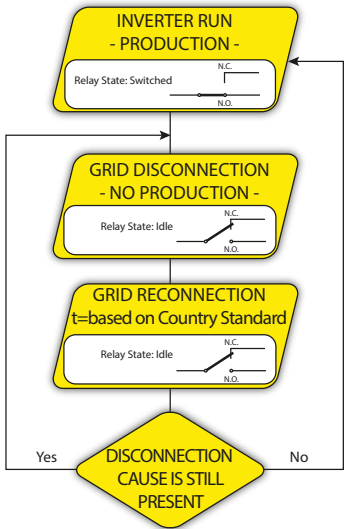

### • Alarm-Contact (Production)

The relay is activated (status: switched) whenever the inverter connects to the grid; as soon as the inverter is disconnected from the grid (for whatever reason that caused disconnection), the relay is in its resting position.

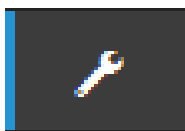

• **Alarm-Contact (alarm ALL - no-latch):**

The relay is activated (status: switched) whenever an error (code Exxx) or warnings related to grid parameters out of range (Warning – codes W003, W004, W005, W006, W007) are present on the inverter. The alarm returns to its resting position when the alarm signal ends, i.e. before the inverter checks the grid parameters after the alarm state. This is because grid control state is not an alarm state but a state of normal operation.

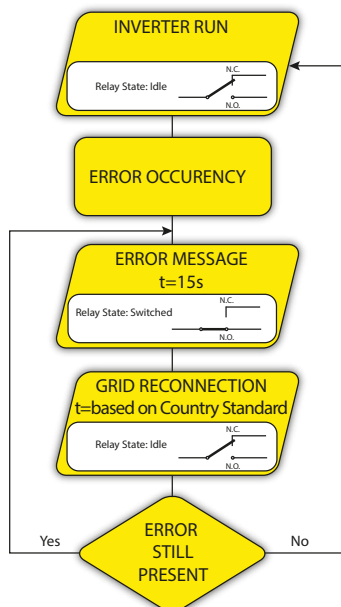

**Selectable alarms for which the relay is activated**

E001	E002	E003	E004	E005	E006
E007	E010	E011	E013	E014	E015
E017	E018	E019	E020	E021	E022
E023	E025	E029	E031	E032	E033
E034	E036	E037	E053	E055	E075
E077	E078	E079	E080	E084	W002
W004	W005	W006	W007	W011	W015
W017	W046	W047	W048		



*In the presence of W003, W004, W005, W006, W007 signalling, the alarm contact switches to then reset itself at the end of the alarm signal. This means that during the absence of grid voltage (display message “Missing Grid”) the alarm contact remains in its resting position.*

• **Alarm-Contact (alarm configurable - no-latch)**

The relay is activated (status: switched) whenever an error (code Exxx) or a warning (code Wxxx) is present from those selected from the list in the dedicated submenu **Output Activation Filter** of the inverter display. The contact returns to its resting position when the alarm signal ends, i.e. before the inverter checks the grid after the alarm state. This is because grid control state is not an alarm state but a state of normal operation.

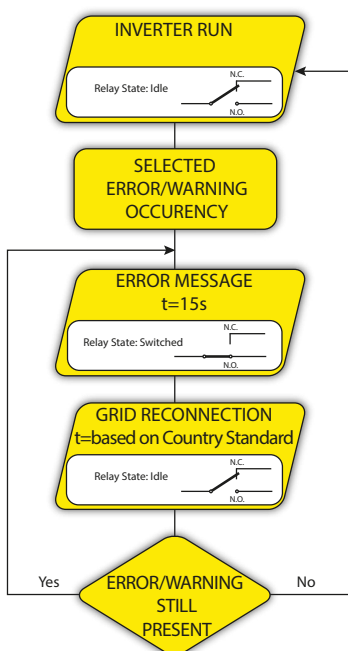

**Selectable alarms for which the relay is activated**

E001	E002	E003	E004	E005	E006
E007	E010	E011	E013	E014	E015
E017	E018	E019	E020	E021	E022
E023	E025	E029	E031	E032	E033
E034	E036	E037	E053	E055	E075
E077	E078	E079	E080	E084	W002
W004	W005	W006	W007	W011	W015
W017	W046	W047	W048		



For the configurable relay operating mode “Alarm Conf.,” the following considerations are valid:

If the alarm condition is persistent, the alarm contact cyclically switches from its resting state to its activated state.



In the presence of W002 signalling (Input UV – input voltage below the limit of operation), the alarm contact switches to then reset itself at the end of the alarm signal. This means that during the reduced input voltage (display message “Waiting Sun”) the alarm contact remains in its resting position.

In the presence of W003, W004, W005, W006, W007 signalling, the alarm contact switches to then reset itself at the end of the alarm signal. This means that during the absence of grid voltage (display message “Missing Grid”) the alarm contact remains in its resting position.

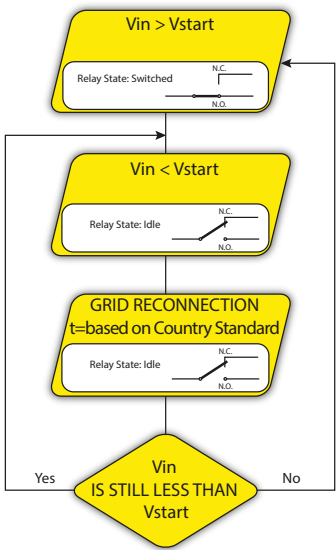

**• Alarm-Contact (crepuscular):**

The relay is activated (status: switched) as soon as the inverter input voltage exceeds the activation voltage set.

The relay switch to rest position when the input voltage drops below 70% of the activation voltage set.

This mode is useful for disconnecting any output transformers that could have unnecessary consumption during the night.

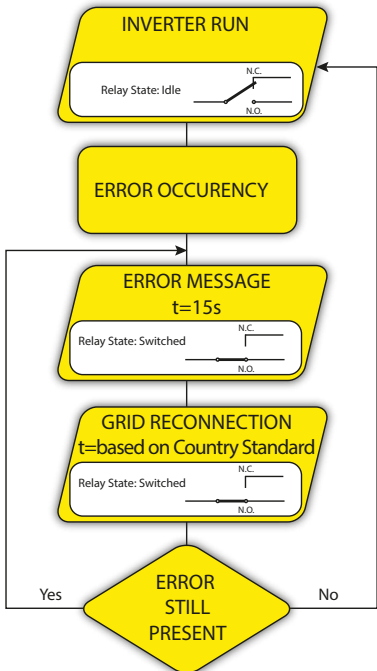

**• Alarm-Contact (alarm ALL - latch):**

The relay is activated (status: switched) whenever an error (code Exxx) or a warning (code Wxxx) is present. When the inverter returns to the normal operating state and reconnects with the grid, the contact returns to its position of rest.

Selectable alarms for which the relay is activated					
E001	E002	E003	E004	E005	E006
E007	E010	E011	E013	E014	E015
E017	E018	E019	E020	E021	E022
E023	E025	E029	E031	E032	E033
E034	E036	E037	E053	E055	E075
E077	E078	E079	E080	E084	W002
W004	W005	W006	W007	W011	W015
W017	W046	W047	W048		

If the alarm condition is persistent, the relay will remain activated (status:switched)

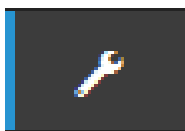

• **Alarm-Contact (alarm configurable - latch):**

The relay is activated (status: switched) whenever an error (code Exxx) or a warning (code Wxxx) is present from those selected from the list in the dedicated submenu **Output Activation Filter** of the inverter display (see the table below). When the inverter returns to the normal operating state and reconnects with the grid.

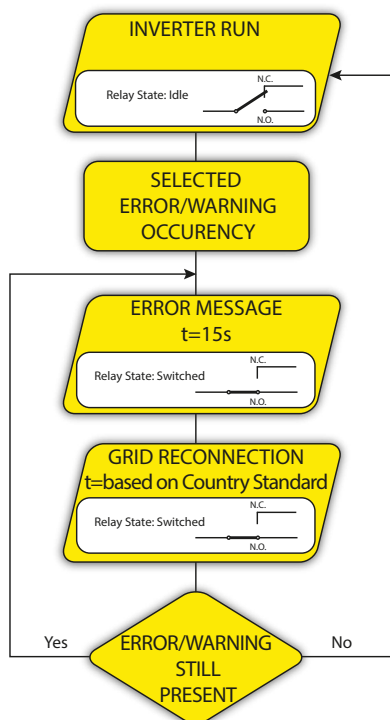

**Selectable alarms for which the relay is activated**

E001	E002	E003	E004	E005	E006
E007	E010	E011	E013	E014	E015
E017	E018	E019	E020	E021	E022
E023	E025	E029	E031	E032	E033
E034	E036	E037	E053	E055	E075
E077	E078	E079	E080	E084	W002
W004	W005	W006	W007	W011	W015
W017	W046	W047	W048		

*If the alarm condition is persistent, the relay will remain activated (status:switched)*

• **Alarm-Contact (alarm configurable - matrix):**

In this mode, it is possible to configure the behaviour of the alarm relay according to an error table which can be setup with the Web User Interface. In the table it is possible to select the alarms or warnings for which the alarm relay is activated (status: switched); for each individual alarm it is also possible to select the “Latch” or “No Latch” mode.

**Country Standard**

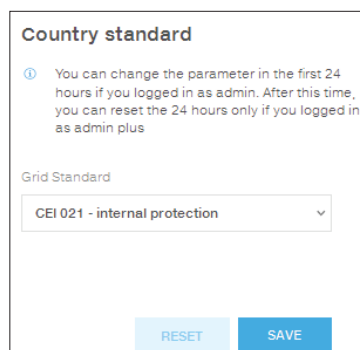

By accessing to the **Country Standard** sub-menu you can modify the grid standard within 24 hours while the inverter is operating.



*After the grid standard was set you have 24 hours to make any changes to the grid standard value; 24 hours later the **Country Standard** sub-menu will be locked, and any subsequent changes can only be made accessing with **Admin Plus** privileges. Refer to the dedicated section on this topic in the manual to know how to unlock the **Country Standard** sub-menu.*

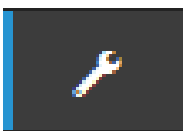

## Firmware Update

By accessing to the **Firmware Update** sub-menu you can upgrade the firmware of the inverter and his components selecting a Remote firmware Update or a Local firmware Update.



*Perform the update during good irradiation conditions (avoid the dawn and dusk hours). An interruption of updating process could damage the inverter!*

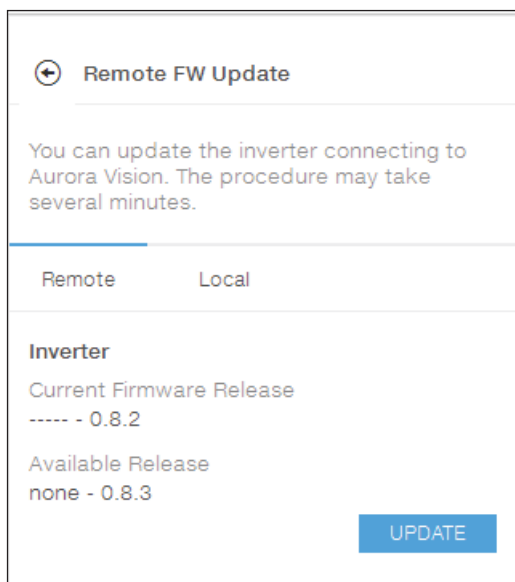

### • Remote firmware Update:

- In remote mode, the firmware will update automatically, searching the last available firmware on FIMER servers, by clicking the “CHECK” button.

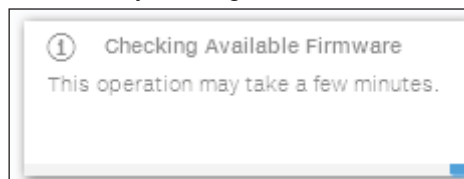

- After the finish of the checking process the available release will be notified on the bottom part of the section
- Click on “UPDATE” button to start with the updating process.

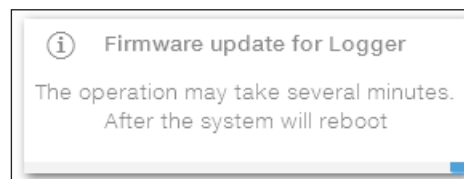

### • Local firmware Update:

By updating in local mode, the firmware have to be selected and uploaded from local folder of the used devices to access to the web server.

The latest firmware version is available from the download area of the website [www.fimer.com](http://www.fimer.com) or from <https://registration.solar.fimer.com>

- Click on “FW SELECT” and select the firmware package previously downloaded.

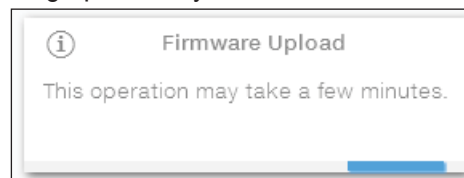

- Click on “UPDATE” button to start with the updating process.

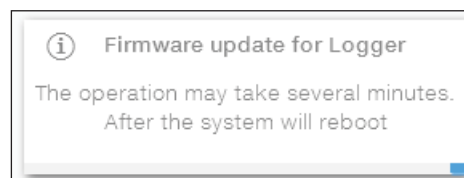



## Date and Time

In the **Date and Time** sub-menu it's possible to set the date, time and time zone.

The inverter will propose these fields when the time protocol is available).

When it's not possible for the inverter to detect the time protocol, these fields have to be manually entered.

### Date and Time

✔ Network Time Protocol server has been detected and it will be used to keep the system clock synchronized.

Date ✔

Feb 22, 2017

SET by the NTP server

Time ✔

4:52 PM

SET by the NTP server

Time Zone

Europe/Berlin GMT+01:00 ▼

SAVE

## Reset Manufacturing *(Only visible with Admin Plus privileges)*

In the **Reset Manufacturing** sub-menu it's possible to reset country standard, restore default and the connectivity reboot.



## INFORMATION

In the **INFORMATION** Section it's possible to view the general informations about the embedded Web User Interface.

it's possible to access the following sub-menus:

- **Product Info**
- **Privacy Policy**
- **Provider Information/Impressum**
- **Acknowledgments**
- **Release Notes**

## General conditions

Routine and periodic maintenance operations must only be carried out by specialized staff with knowledge of how to perform these tasks.



*Some inverter parts may be subject to voltages that could be hazardous for the operator. Before performing any work on the inverter, refer to “Inverter total de-energization and safe access” chapter on this manual to know all the necessary steps to safely operate on the inverter.*



*For cleaning, DO NOT use rags made of filamentary material or corrosive products that may corrode the equipment or generate electrostatic charges.  
Avoid temporary repairs. All repairs should be carried out using only genuine spare parts.  
The maintenance technician is to promptly report any anomalies.*

DO NOT allow the equipment to be used if problems of any kind are found.



*Always use personal protective equipment (PPE) provided by the employer and comply with local safety regulations.*



## Inverter total de-energization and safe access

The purpose of this chapter is to provide instructions for de-energize the PVS-60-TL-US models in order to allow access to active parts inside the inverter. The procedure describes the steps to perform a total isolation and thus includes operations on devices that are located outside the inverter. The total isolation approach consider **the disconnection of the inverter from any possible voltage source to which the inverter may be connected**. In the procedure the test of residual voltage potentially present inside the inverter is included. This procedure is intended exclusively to be used by skilled or trained persons in accordance with safety standards EN 50110-1, EN 50110-2 (CENELEC/CEN) and NFPA 70E or equivalent standards. Furthermore, only these skilled or trained persons are permitted to carry out the procedure.

### Operator and maintenance personnel skills/prerequisites



*Personnel in charge of using and maintaining the equipment must be skilled for the described tasks and must reliably demonstrate their capacity to correctly interpret what is described in the manual.*



*For safety reasons, the installation must be performed by qualified installers and/or licensed electricians in accordance with the existing regulations in the country of installation and in accordance of all safety rules for performing electrical works. The installers must have demonstrated skills and knowledge of the inverter's structure and operation.*



*Inverter operation and maintenance by a person who is NOT qualified, is intoxicated, or on narcotics, is strictly forbidden.*



*The customer has civil liability for the qualification and mental or physical state of the personnel who interact with the equipment. They must always use the personal protective equipment (PPE) required by the laws of the country of destination and whatever is provided by their employer.*

The following job requirements and qualifications are required to operate on the inverter:

- Compliance with all legal standard in force in the installation country to perform the electrical work described on this procedure.

## Clothing and protection of personnel

The following Personal Protective Equipment (PPE) are required to perform any intervention on the inverter:

- Insulating composite gloves class 0 (1000Vac-1500Vdc) electric arc tested, combined with protective overglove in leather. Reference standards NFPA 70E and OSHA 29 CFR Part 1926.
- Basic arc-flash protection wear (8 cal/cm<sup>2</sup>), combined with overall arc-flash protection (25 cal/cm<sup>2</sup>). Reference standards NFPA 70E.
- Arc-flash protection for head (arc-hood) with helmet included (40 cal/cm<sup>2</sup>). Reference standards NFPA 70E.
- Safety shoes. Reference standards NFPA 70E.

## Safety equipment and tools

The following equipment and tools are required to perform any intervention on the inverter:

- Disconnect tool for DC side (PV) connectors.
- Voltage detector (EN 61243-2) capable of 3kVdc and up to 1kVac.
- DC current clamp.
- Multimeter, rated 1500V (only to test the absence of short circuits).
- Safety tags “work in progress, do not operate”.
- Padlocks.

## Inverter total de-energization and safe access procedure

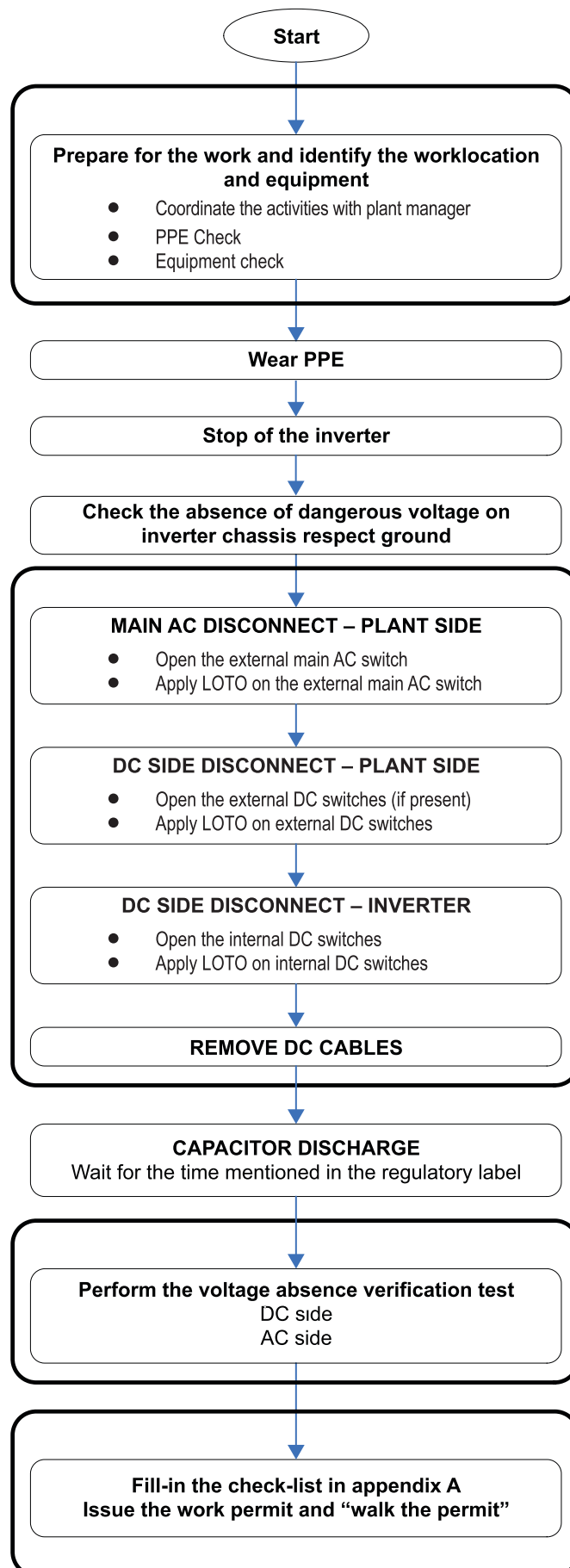



When the device has just been switched off, it may have hot parts as a result of overheating of the heated surfaces (e.g.: transformers, accumulators, coils, etc.) so be careful where you touch.



Some inverter parts may be subject to voltages that could be hazardous for the operator. Before performing any work on the inverter, follow this procedure for safely isolate the inverter.

### 1. Preliminary checks

- Weather conditions: In the risk assessment prior the intervention it is of paramount importance to evaluate the weather conditions. This procedure can be applied only in case of dry environment. Don't proceed in case of rain (even light) or high humidity.
- PPE Check: Verify the integrity of the PPE that is going to be used to perform the operations.
- Equipment check:
  - Check the voltage tester is working correctly:
    - Perform an integrity check of the instrument in general; examine the test terminals, its integrity and make sure they are properly fixed; make sure the batteries level is enough high (don't use the instrument in case the message "LOW BATTERY" is present) or replace them.
    - Perform test of the instrument using an energized AC socket and a DC voltage source (example: battery in the service car) with known voltage level; in case the instrument is provided with a self-test feature, follow the instructions provided in the instrument manual to carry out the self-test.
  - Check the DC current probe is working correctly:
    - Check the DC current probe is properly working, make sure to perform the "ZERO-OFFSET" procedure and to select DC measurement range.

### 2. Wear the appropriate PPE for carrying out the operations (arc-flash rated wearing, dielectric helmet with visor, Arc-flash rated head protection (balaclava), insulating gloves). All the following activities (till the completion of the procedure) must be performed wearing the PPE.

### 3. Check the absence of dangerous voltages on inverter enclosure respect to ground:

- Using a voltage detector, check the absence of dangerous voltage on the inverter chassis. The measurement points are between the inverter chassis (it shall be selected a non-painted point, like one of the screws of the front panel) and a ground point outside the inverter.

#### 4. Operations on External AC switches

The diagram below represents a possible arrangement of the PV plant. Depending on the design choices made by the developer of the plant some of the devices could not be present. Identify the external AC switch(es) in the plant with the support of the plant manager.

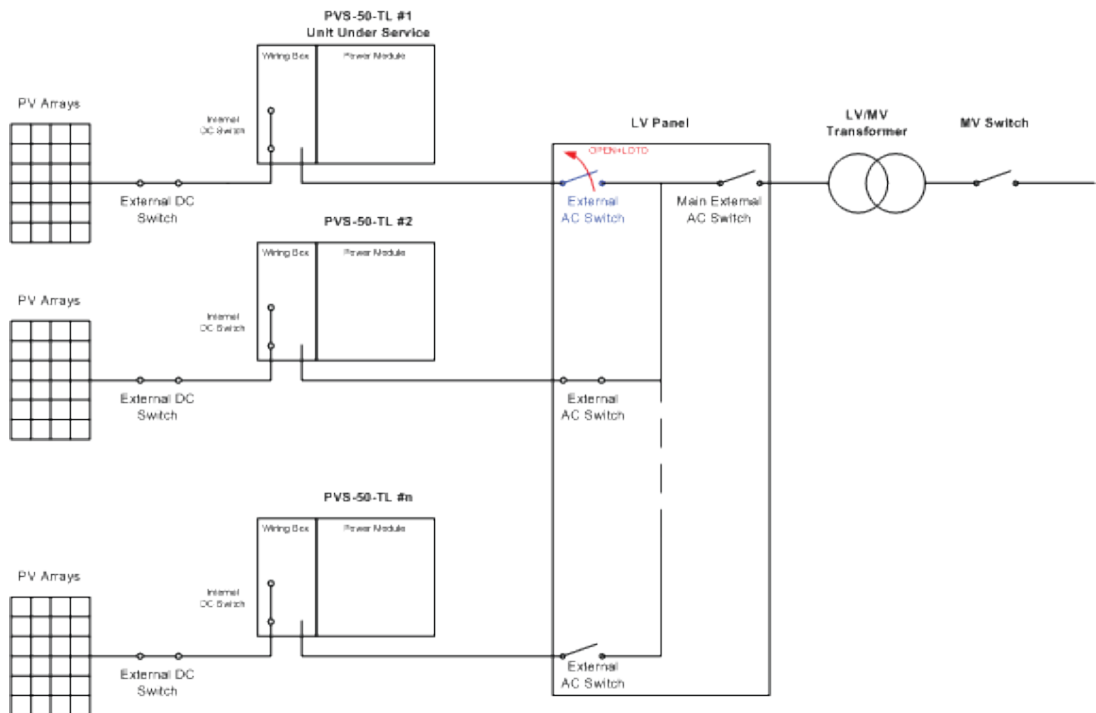

- Open the external AC disconnect switch or the main external AC disconnect switch (blue in below picture) outside the inverter (IEC 60364-7-712.536.2.2 and NFPA 70E). In case none of the LV AC switches are present, the MV switch must be opened.
- Affix designated lock preventing operation onto any external AC disconnect device, affixing designated tags (LOTO procedure).



*Identification of the external switch may require the cooperation of the plant manager and it must be included in the switching plan defined during the preparation of the work.*

- Check on the status LEDs **05** the shutdown command has been carried out (Missing Grid status):
  - **Power** LED (Green): Flashing
  - **Alarm** LED (Yellow): ON (solid)
  - **GFI** LED (Red): OFF
  - **WLAN/LAN** LED (Blue): Depends by the communication status.

## 5. Operations on External DC switches

**Note:** In case of absence of External DC disconnect device skip this step.

The diagram below represents a possible arrangement of the PV plant. Depending on the design choices made by the developer of the plant some of the devices could not be present. Identify the external DC switch(es) in the plant with the support of the plant manager.

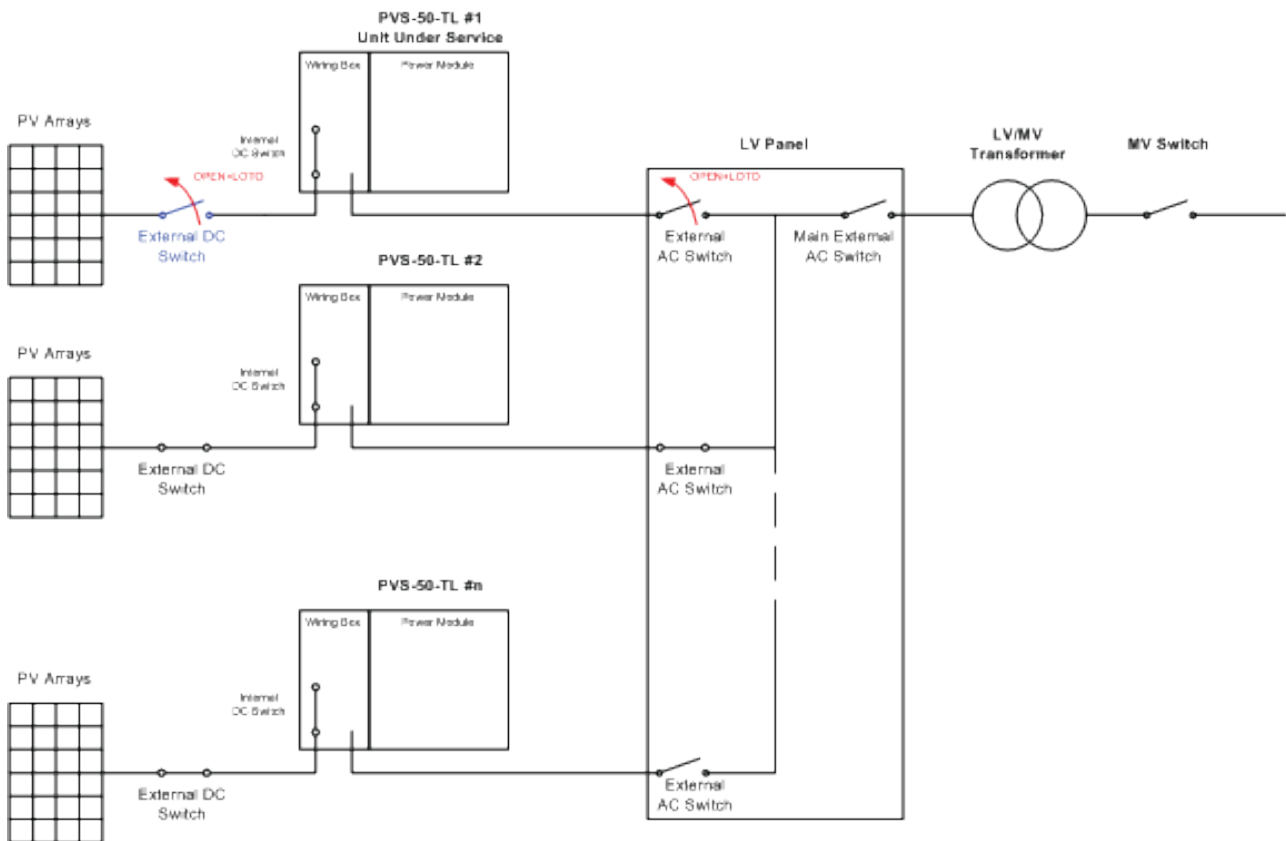

- Open the external DC disconnect switch (blue in below picture) outside the inverter (IEC 60364-7-712.536.2.2 and NFPA 70E).
- Affix designated lock preventing operation onto any external DC disconnect device, affixing designated tags (LOTO procedure).



Identification of the external switch may require the cooperation of the plant manager and it must be included in the switching plan defined during the preparation of the work.

- Check on the status LEDs **05** the shutdown command has been carried out (Missing DC voltage status): **All LEDs OFF**.



The time needed for the complete shut-down of the LEDs depends by the input voltage of the inverter. The complete shut-down of the LEDs may require some minutes.

## 6. Operations on Internal DC disconnect switch(if present) 15

- Open the internal DC switch 15 (blue in the below picture).

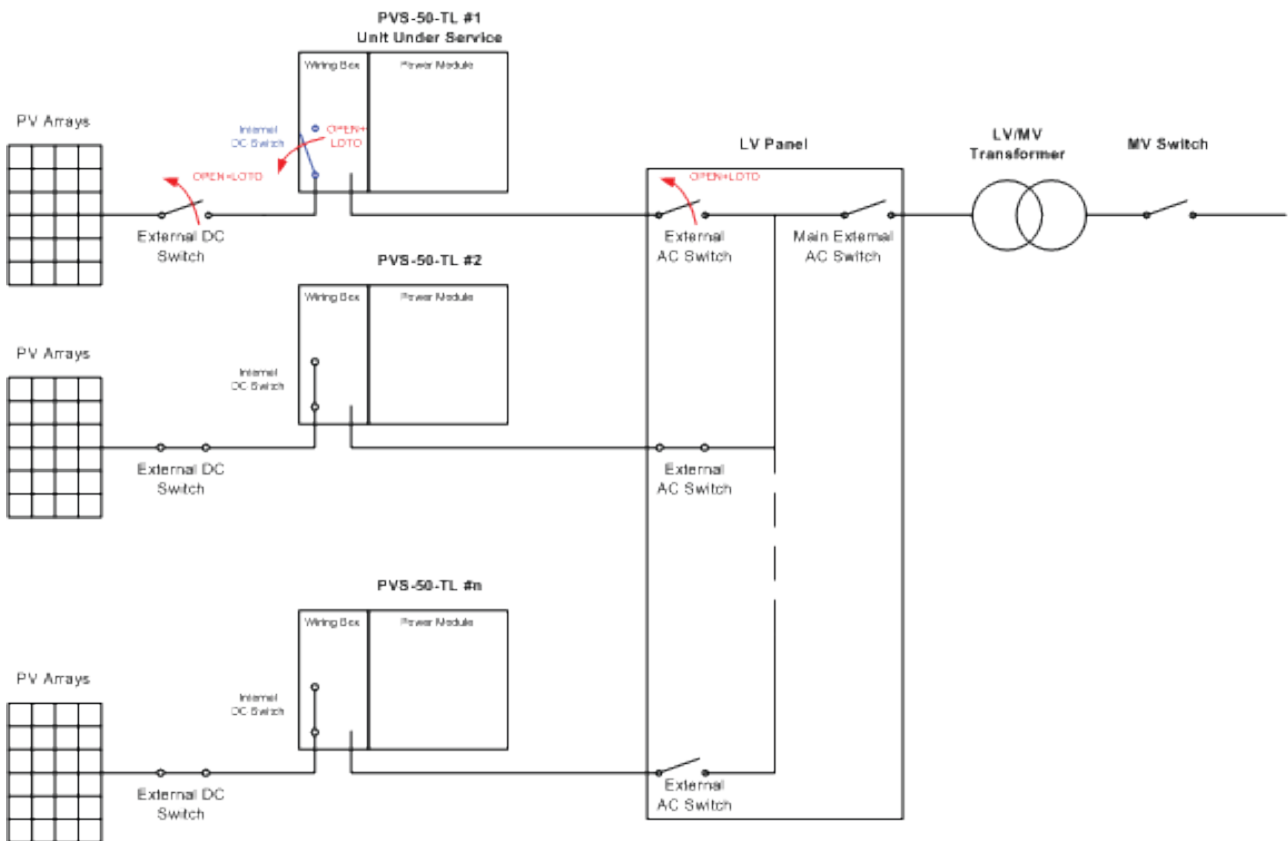

- Affix designated lock preventing operation onto DC disconnect switch 15, affixing designated tags (LOTO procedure).
- Check on the status LEDs 05 the shutdown command has been carried out (Missing DC voltage status): **All LEDs OFF**.



*The time needed for the complete shut-down of the LEDs depends by the input voltage of the inverter. The complete shut-down of the LEDs may require some minutes.*

**7. Remove the DC quick fit connectors 09**

- Using the current clamp check the absence of current on DC side, measurement each positive and negative DC input string cables (check the correct setting of the current sensor).
- Remove all quick fit DC connectors using the dedicated disconnect tool. To avoid mechanical interferences, use a cable tie to collect the disconnected cables.



*It is highly recommended to put labels on the cables in order to easily reconnect them to the correct connectors once completed the service activities.*

**8. Discharge of the capacitor**

- Wait the internal capacitors to be discharged. The discharge time of the stored energy is indicated on the regulatory label.

**9. Open the wiring box cover**

- Access to the wiring box by removing the front cover 04.
- Visually inspect the components to identify the presence of any overheating, signs of electric arcs, failure of the insulating devices, loosen connections or cables not connected.

**10. Voltage absence test on DC side**

*Before to approach the below operations all the steps from 1 to 9 included must be successfully completed.*

Using the voltage detector, check the absence of voltage on the DC terminal connectors 12 between:

- Each positive input and ground
- Each negative input and ground
- Positive input and negative input of each input section of the inverter.

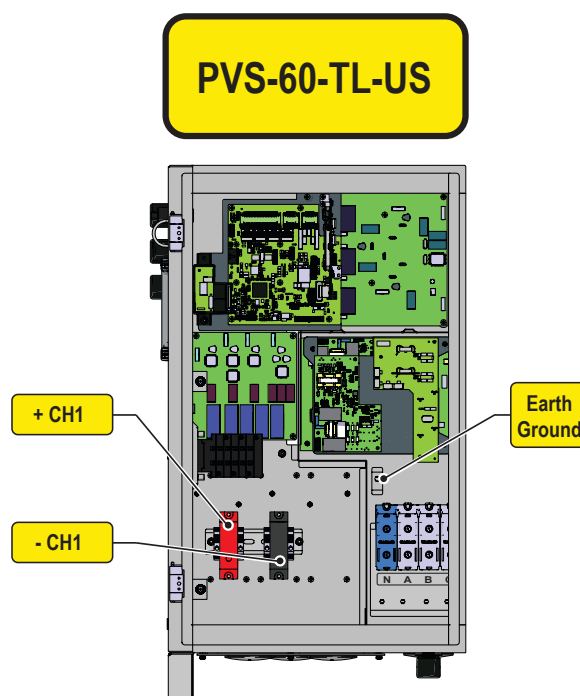



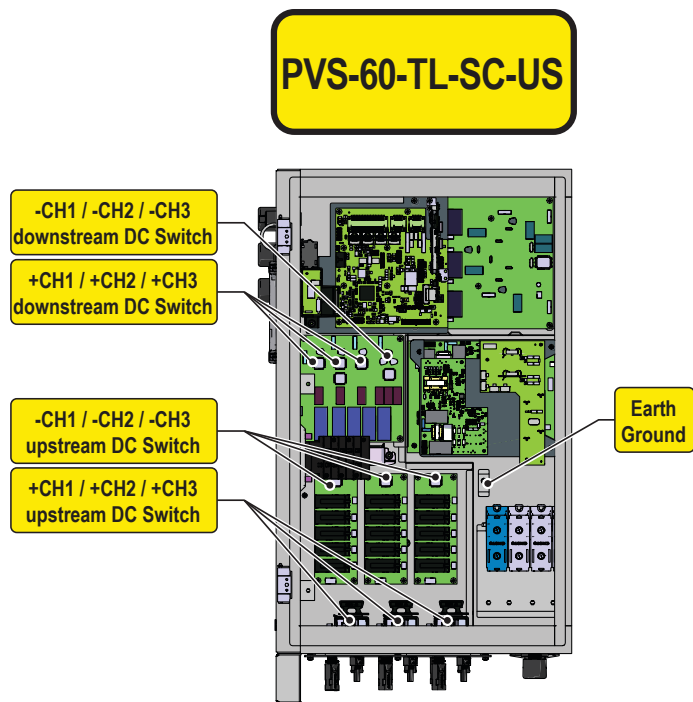
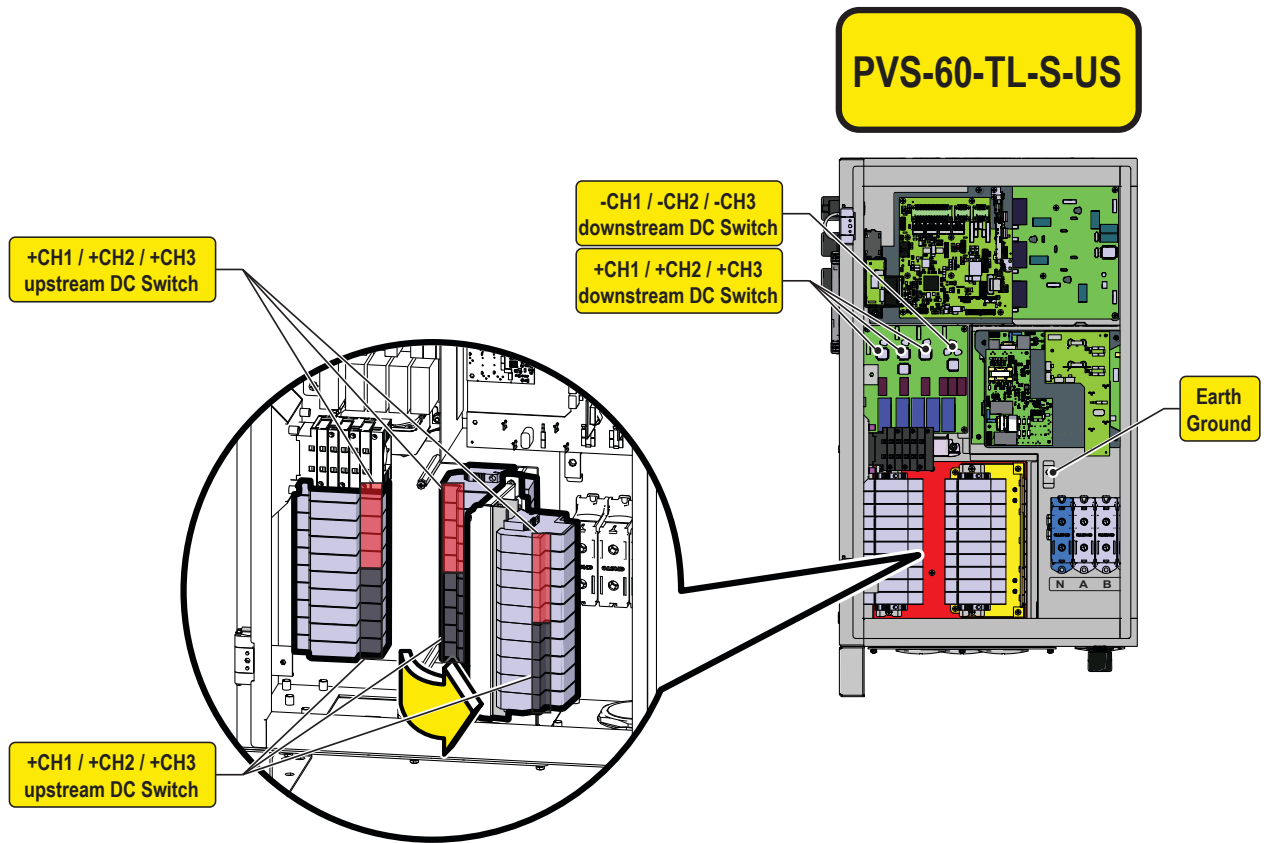

### 11. Voltage absence test on AC side

Using the voltage detector, check the absence of voltage on the AC terminal connectors (lift the protective sheet to reach the connectors) between:

Phase to ground	Phase-to-phase	Phase-to-neutral
L1-GND	L1-L2	L1-N
L2-GND	L2-L3	L2-N
L3-GND	L3-L1	L3-N
N-GND		

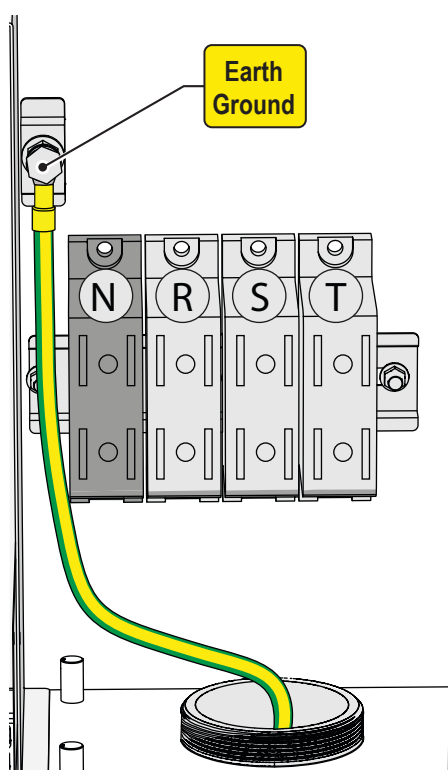

### 12. Check list to be filled prior the access to the inverter

- Purpose of the checklist is to verify that all the operations mentioned in the procedure have been carried out. The checklist below must be attached to the intervention report.

CHECK	STATUS $\checkmark$ or X
Prepare for the work and identify the work location and equipment	
PPE and Equipment Check	
PPE wearing	
<b>OPERATIONS AT PLANT LEVEL [*]</b>	
Check the absence of dangerous voltages on inverter chassis respect ground	
Operations in External AC switch	
Operations in External DC Switch	
<b>OPERATIONS AT INVERTER LEVEL</b>	
Operations on internal DC switches (If present)	
verification of the absence of current on DC cables and disconnection of the DC quick-fit connectors	
Wait the discharge of the internal capacitor	
Open the cover and visually inspect the components	
<b>VOLTAGE ABSENCE TEST</b>	
Voltage absence check inside wiring box on DC side	
Voltage absence check inside wiring box on AC Side	
<b>ISSUE WORK PERMIT</b>	
Issue work permit and "Walk the permit" – Check list filling	
== ONLY if all checks are POSITIVE ( $\checkmark$ ) the ACCESS IS ALLOWED =	

[\*]: Identification of the external switch may require the cooperation of the plant manager and it must be included in the switching plan defined during the preparation of the work.

## Routine maintenance

Routine maintenance operations should not be considered obligatory, but rather as recommended in order to maintain the efficiency of the PV system.



*It is recommended that maintenance operations are only performed by qualified personnel or FIMER personnel (under a servicing contract). The maintenance schedule may vary depending on the environmental conditions of the installation premises.*

**Table: routine maintenance**

<p><b>Annual visual inspections</b></p>		<ul style="list-style-type: none"> <li>• Check that the inverter is operating properly, without any alarm signals</li> <li>• Ensure all labels and safety symbols are visible</li> <li>• Check the integrity of the cables, connectors and cable glands outside the inverter</li> <li>• Check that the environmental conditions have not changed dramatically from those on installation.</li> <li>• Check there are no obstacles (animals, insects, leaves, vines or plants growing in heat sink, or anything which could reduce the heat exchanging capacity of the heat sink) at the top, at the bottom and between the fins.</li> </ul>
<p><b>Annual operations</b></p>		<ul style="list-style-type: none"> <li>• Check the tightening of the cable glands and the screw terminal blocks</li> <li>• Check the front cover is secured to the wiring boxes</li> <li>• If there is no monitoring system, check the record of alarms and errors using the indications provided in the manual in order to check recent notification of recent malfunctions.</li> <li>• For the models with AC+DC disconnect switch, it is recommended that once a year the disconnect switch is operated a number of times (at least 10) to keep the contacts clean and prevent oxidation. This operation must be carried out in periods with low input power or at night.</li> </ul>
<p><b>Annual cleaning</b></p>		<ul style="list-style-type: none"> <li>• Clean the equipment; verify, in particular, clean the lower array of the cooling fan assembly and the heat sink.</li> </ul>

## Troubleshooting



Operations on the inverter to identify and address any faults may only be performed by the installer or by qualified personnel.

### Internal Webserver and wireless communication troubleshooting

The following table gives a list of main and common errors or problems relating to the wireless communication between inverter and user devices.

Problem	Possible causes	Solution
The internal webserver cannot be accessed.	ADMIN or USER password forgotten.	Reset the passwords by clicking on "Forgot your password"; The passwords can be reset after having entered the "Product Key" code that can be found on the "Wireless Identification Label".
The inverter is able to identify a wireless network but is unable to connect to it.	The signal between the inverter and the wireless router to which the board wants to connect is too weak.	Modify the position of the wireless antenna, the inverter or the router.
		Make sure that the inverter has not been installed near obstacles which could affect the communication with the wireless router (for example: metal cages or walls, walls in reinforced concrete, electromagnetic fields).
		Move the router as close as possible to the inverter.
The inverter is able to identify a wireless network but is unable to connect to it.	The wireless network to which the inverter is to be connected, could require the user to enter a username and password to allow navigation (for example, with a public wireless network or a hotel).	Install a wireless signal repeater in order to extend the network to which the inverter is to be connected; then connect the inverter to the repeater.
		Unfortunately the inverter cannot be connected to these types of wireless networks. Connect the inverter to an alternative wireless network.
The Inverter has not identified the wireless network to which connection is required.	The wireless network to which the Inverter is to be connected, is set so as not to be identified (hidden network).	The Inverter is not able to connect to a hidden network. Set the wireless network to which the inverter is to be connected (visible network), then identify and connect the Inverter to the wireless network as normal.
		Modify the position of the wireless antenna, the inverter or the router.
		Make sure that the inverter has not been installed near obstacles which could affect the communication with the wireless router (for example: metal cages or walls, walls in reinforced concrete, electromagnetic fields).
The Inverter has not identified the wireless network to which connection is required.	The signal between the inverter and the wireless router to which the board wants to connect is too weak.	Move the router as close as possible to the inverter.
		Install a wireless signal repeater in order to extend the network to which the inverter is to be connected; then connect the inverter to the repeater.
The wireless board does not communicate correctly with the inverter inside of which it is installed (inconsistency in the detected data read by the board), or when working in "Access Point Mode", it's not possible to access the internal webserver.	The wireless board of the inverter could be damaged.	Request a service intervention to check that the inverter wireless board is working correctly.
	Wrong Inverter Date/Time settings.	Check if Date/Time has correctly set on the inverter; correct it if necessary.
Alternating difficulties in the local connection to the internal webserver.	The inverter might not be correctly powered (for example, if the inverter is switched off at night, the internal webserver cannot be accessed).	Access to the internal webserver only when the inverter is correctly powered.
	The wireless connection signal between the device in use and the router or the Inverter, may not have sufficient power or it may be disturbed by obstacles which affect the communication.	Make sure that the signal between the wireless devices which interact with the inverter are sufficiently high and that any obstacles such as metal cages or walls, walls in reinforced concrete or strong electromagnetic fields do not affect communication.









Problem	Possible causes	Solution
Although the Inverter has been configured correctly in "Station Mode" and works correctly on the local network, no data has been transmitted to the Aurora Vision®.	The MAC address used to register the inverter on the Aurora Vision® platform is not the same as the actual address associated with the inverter.	Make sure that the MAC address registered on the Aurora Vision® platform is actually the one associated with the inverter. If it is not, modify the registered MAC address.
	The wireless network to which the Inverter is connected, could be protected by a Firewall which prevents the remote exchange of data with the Aurora Vision® platform.	Contact the network administrator in order to have the Firewall configured so that the remote exchange of data between the Inverter and the Aurora Vision® platform is allowed.
It is not possible to access the Internal webserver using the IP address when the inverter is operating in "Station Mode – DHCP".	An incorrect dynamic IP address is being used to access the Internal Webserver or the IP address could have been modified by the wireless router to which the inverter is connected.	Access the Internal Webserver using via "AP Mode" (refer to dedicated section to know how to connect via "AP Mode") and read the current IP Address in " <b>NETWORK &gt; WLAN</b> " section.
		Access the Internal Webserver using the "Host Name" that could be obtained writing this url <b>http://ABB-XX-XX-XX-XX-XX-XX.local</b> replacing the "X" with the hex digits of the wireless MAC address of the inverter (it can be found on the "Wireless Identification Label" placed on the side of the inverter or applied during the commissioning phase to the quick installation guide on cover page). The DNS or multicast service must be enabled on router. <b>Note: This connection method doesn't work on Android devices.</b>
	The IP Address used to access the Internal Webserver was lost.	Access the inverter display menu <b>WLAN Logger&gt;Info&gt;View IP</b> to obtain the IP Address assigned by the router to the inverter. If possible, access the pages of the wireless router web server to which the inverter is connected and read the new dynamic IP address assigned to the Inverter.
	The wireless router doesn't allow the connection to local IP address. Typically this happen on company networks.	Contact the network administrator to allow the wireless router to connect to local IP address.
	The device doesn't allow the connection to local IP address. Typically this happen with company devices.	Contact the system administrator to allow the device to connect to local IP address.
Using an Android devices, a notification advise that internet connection is missing when trying to connect to the Access Point wireless network created by the inverter and ask for connection confirmation.	Known behavior of Android devices. Android OS always check if internet connection are available and ask for confirmation if it's not present.	Confirm the connection request in the notification of Android devices by clicking "Yes".
It is not possible to view the Pdf Auto-test report using an Ios devices.	Popup opening is not allowed on Ios browser.	Allow the popup opening in the browser settings of the Ios devices (A notification will advise you for enable popup when trying to view the pdf autotes report).

## Alarm Messages of the Inverter

In order to understand and resolve warning (Wxxx) or error (Exxx) signals that appear in the Alarm section of the internal webserver or on the inverter's display, follow the table given in the following paragraph.











The equipment can notify errors/warnings in the Alarm section of the internal webserver or on the display (where present) only if the input voltage is greater than the  $V_{dcm}$  voltage (POWER Led flashing or lit; see chapter on operation)

*The following table gives the complete list of errors/warnings relating to string inverters. Some error/warning codes may not be used depending on the inverter model installed.*

- Error code - Error message - Warning	Name of Alarm and Cause	Solution
- No code - Ground F -  Red LED	<b>Ground fault of photovoltaic generator:</b> The alarm is generated when a leakage current to ground is detected in the DC section of the system.	<ul style="list-style-type: none"> <li>• Measure the isolation resistance using a megohmmeter positioned in the photovoltaic array (positive terminal short-circuited at the negative pole) compared to ground. The measurement is strongly influenced by the environmental conditions, so must be made under the same conditions in which the error occurred.</li> <li>- If the value measured is lower than 1 megaohm, a check must be carried out by a technician/installer on the photovoltaic generator to identify and eliminate the problem.</li> <li>- If the value measured is higher than 1 megaohm and the error signal persists, contact customer assistance.</li> </ul>
- No code - NEW SYSTEM PART REFUSED! -  Flashing yellow LED	<b>Lack of linkage of the new system part:</b> The components inside the inverter (e.g. display, fuse board, communication and control board, etc.) are not inter-linked. This occurs following the replacement of one of the components inside the inverter.	<ul style="list-style-type: none"> <li>• Link the components inside the inverter by accessing the "Settings &gt; Service &gt; Accept boards" (refer to the procedure given in this manual).</li> <li>- If the signal persists also following the linking of the components, contact customer assistance.</li> </ul>
- No code - SET COUNTRY or NO NATION -  No LED	<b>SET COUNTRY or NO NATION:</b> Indicates that in the installation phase the grid standard was not set on the inverter.	<ul style="list-style-type: none"> <li>• Set the grid standard of the country of installation following the instructions given in this manual for the inverter.</li> <li>- If the signal persists also after the grid standard has been set, contact customer assistance.</li> </ul>
- No code - Missing Grid -  Yellow LED	<b>Missing Grid:</b> The inverter does not detect grid voltage (AC side).	<ul style="list-style-type: none"> <li>• Check the grid voltage on the inverter's AC terminal block.</li> <li>- Should it be absent, check any protection work on the line and the presence of grid voltage on the supply point.</li> </ul>
- No code - Memory fault -  Flashing yellow LED	<b>Memory fault:</b> The inverter has detected a communication problem with the memory board on which the inverter saves the daily value of energy produced.	<ul style="list-style-type: none"> <li>• Remove the memory board and check the welding of all the connector's terminals. Subsequently reinsert the memory board and check that it is correctly inserted into the dedicated slot</li> <li>- If the signal persists also following the above checks, contact customer assistance.</li> </ul>
- No code - Waiting Sun -  Flashing green LED	<b>Waiting Sun:</b> The inverter goes into the "Waiting Sun" stage when, following a W001 and/or W002 warning, the voltage from the photovoltaic generator is less than the activation voltage ( $V_{start}$ ).	<ul style="list-style-type: none"> <li>• Check the input voltage on the inverter.</li> <li>- If it does not exceed <math>V_{start}</math>, check for the presence of sufficient irradiation and the correct composition of the system.</li> <li>- If it exceeds <math>V_{start}</math>, contact customer assistance</li> </ul>
- W001 - Sun Low -  Yellow LED	<b>Insufficient irradiation (Low input voltage on switching on the inverter):</b> Incorrect configuration of the PV generator or an "on the limit" configuration for the inverter's minimum input voltage.	<ul style="list-style-type: none"> <li>• Check the input voltage on the inverter.</li> <li>- If it does not exceed <math>V_{start}</math>, check for the presence of sufficient irradiation and the correct composition of the system.</li> <li>- If it exceeds <math>V_{start}</math>, contact customer assistance</li> </ul>
- W002 - Input UV -  Yellow LED	<b>Insufficient irradiation (Low input voltage on switching off):</b> Incorrect configuration of the photovoltaic generator or an "on the limit" configuration for the inverter's minimum input voltage.	<ul style="list-style-type: none"> <li>• Check the input voltage on the inverter.</li> <li>- If it does not exceed <math>V_{start}</math>, check for the presence of sufficient irradiation and the correct composition of the system.</li> <li>- If it exceeds <math>V_{start}</math>, contact customer assistance</li> </ul>

- Error code - Error message - Warning	Name of Alarm and Cause	Solution
- W003 - Grid Fail - Yellow LED	<b>Parameters of grid voltage outside range:</b> This error signal occurs when during the inverter's normal operation the grid parameters exceed the limits set by the operator: - Grid voltage absent (after the signal the inverter goes to "Missing Grid") - Unstable grid voltage (values too low or too high) - Unstable grid frequency	<ul style="list-style-type: none"> <li>• Check the grid voltage on the inverter.</li> <li>- Should it be absent, check for absence of grid voltage on the supply point.</li> <li>- If, on the other hand, the voltage tends to rise (when the inverter is connected) there is high line or grid impedance.</li> <li>• Check the grid voltage also on the supply.</li> <li>- If it is high, it means that there is high grid impedance. In this case, ask the operator to adjust the grid voltage. If the operator authorises a change to the inverter's parameters, agree the new limits with customer assistance</li> <li>- If the voltage at the point of supply is much lower than that measured on the inverter, it is necessary to adjust the line (inverter-contactor).</li> <li>- If the voltage and the grid frequency come back within the limits (also when the inverter is connected to the grid), contact customer assistance</li> </ul>
- W004 - Grid OV - Yellow LED	<b>Grid overvoltage:</b> This error signal occurs when during the inverter's normal operation the grid voltage exceeds the maximum limit set by the operator.	<ul style="list-style-type: none"> <li>• Check the grid voltage on the inverter.</li> <li>If the voltage tends to rise (when the inverter is connected), there is a problem of high line or grid impedance.</li> <li>• Check the grid voltage also on the supply.</li> <li>- If it is high, it means that there is high grid impedance. In this case, ask the operator to adjust the grid voltage. If the operator authorises a change to the inverter's parameters, agree the new limits with customer assistance</li> <li>- If the voltage at the point of supply is much lower than that measured on the inverter, it is necessary to adjust the line (inverter-contactor).</li> <li>- If the voltage and the grid frequency come back within the limits (also when the inverter is connected to the grid), contact customer assistance</li> </ul>
- W005 - Grid UV - Yellow LED	<b>Grid undervoltage:</b> This error signal occurs when during the inverter's normal operation the grid voltage exceeds the minimum limit set by the operator.	<ul style="list-style-type: none"> <li>• Check the grid voltage on the inverter.</li> <li>• Check the grid voltage also on the supply.</li> <li>- If it is high, it means that there is high grid impedance. In this case, ask the operator to adjust the grid voltage. If the operator authorises a change to the inverter's parameters, agree the new limits with customer assistance</li> <li>- If the voltage at the point of supply is much lower than that measured on the inverter, it is necessary to adjust the line (inverter-contactor).</li> <li>- If the voltage and the grid frequency come back within the limits (also when the inverter is connected to the grid), contact customer assistance</li> </ul>
- W006 - Grid OF - Yellow LED	<b>Grid over-frequency:</b> This error signal occurs when during the inverter's normal operation the grid frequency exceeds the maximum limit set by the operator.	<ul style="list-style-type: none"> <li>• Check the grid frequency in the inverter.</li> <li>• Check the grid frequency also on the supply:</li> <li>- If the voltage and the grid frequency come back within the limits (also when the inverter is connected to the grid), contact customer assistance</li> </ul>
- W007 - Grid UF - Yellow LED	<b>Grid under-frequency:</b> This error signal occurs when during the inverter's normal operation the grid frequency exceeds the minimum limit set by the operator.	<ul style="list-style-type: none"> <li>• Check the grid frequency in the inverter.</li> <li>• Check the grid frequency also on the supply:</li> <li>- If the voltage and the grid frequency come back within the limits (also when the inverter is connected to the grid), contact customer assistance</li> </ul>
- W010 - Fan Fail - Flashing yellow LED	<b>Fan Fail:</b> This error occurs when there is a malfunction in the fan/fans inside the inverter.	<ul style="list-style-type: none"> <li>• Error inside the inverter and cannot be checked externally.</li> <li>- If the alarm repeats persistently, contact customer assistance.</li> </ul>
- W011 - Bulk UV - Yellow LED	<b>Low "Bulk" voltage (DC-DC circuit):</b> The alarm (which is a warning and not an error) is generated when the voltage at the heads of the bulk capacitors does not reach the threshold for the operation of the inverter (internal unchangeable threshold).	<ul style="list-style-type: none"> <li>• Raise the value of the activation voltage (Vstart) so as to have sufficient power from the PV generator at the time of the inverter's grid connection.</li> <li>• Check the input voltage on the inverter.</li> <li>- If it does not exceed Vstart, check for the presence of sufficient irradiation and the correct composition of the system.</li> <li>- If it exceeds Vstart, contact customer assistance.</li> </ul>



- Error code - Error message - Warning	Name of Alarm and Cause	Solution
- W012 - Batt. Low -  Flashing yellow LED	<b>Battery Low:</b> The inverter has detected a backup battery voltage that is too low.	<ul style="list-style-type: none"> <li>• Check that the date/time are set correctly and, if they are not, set them.</li> <li>Subsequently arrange to completely switch off the inverter (on both AC and DC) and wait a few minutes.</li> <li>Finally, restart the inverter and check whether the date/time are now correctly set or whether they have reset to 01/01/2000. In this case replace the battery with the inverter completely switched off (isolate AC and DC side) being careful to maintain the polarity</li> </ul>
- W013 - Clock Fail -  Flashing yellow LED	<b>Clock Fail:</b> The alarm occurs when there is a difference of more than 1 minute in the time shown the internal webserver compared to the internal time of the microprocessors and indicates a malfunction of the clock circuit.	<ul style="list-style-type: none"> <li>• Error inside the inverter and cannot be checked externally.</li> <li>- If the alarm repeats persistently, contact customer assistance.</li> </ul>
- W015 - Island Detect. -  Yellow LED	<b>Disconnection due to Anti-Islanding:</b> The inverter has been improperly connected to an island grid.	<ul style="list-style-type: none"> <li>• Check that the grid to which the inverter is connected is not an island grid.</li> <li>- If the grid to which the inverter is connected is an island grid, switch the inverter off and then on again: if the problem persists, contact customer assistance.</li> </ul>
- W017* - String Err. -  Flashing yellow LED * (only for models with monitored string fuses)	<b>Error recorded in measuring string currents:</b> Damaged string protection fuse(s)	<ul style="list-style-type: none"> <li>• Check with a multimeter the state of the fuses (positioned on the fuse boards).</li> <li>- If one or more fuses is open, arrange to replace them and check that the input current on the string(s) does not exceed the rating of the fuses (should parallel strings have been made outside the inverter).</li> <li>- If there are no damaged string fuses and the inverter continues to show the alarm message check whether the settings to be made via the internal webserver are correct (presence or absence of one or more input strings).</li> </ul>
- W018 * - SPD DC Err -  Flashing yellow LED * (only for models with monitored SPD)	<b>Intervention of overvoltage surge arresters on DC side:</b> Overvoltage surge arresters situated on the DC side are damaged.	<ul style="list-style-type: none"> <li>• Observe the inspection window on each surge arrester (DC side). If it is red, the surge arrester is damaged and the cartridge must be replaced.</li> <li>- If the alarm status persists, even if all the surge arresters have a green inspection window, contact customer assistance.</li> </ul>
- W019 * - SPD AC Err -  Flashing yellow LED * (only for models with monitored SPD)	<b>Intervention of overvoltage surge arresters on AC side:</b> Overvoltage surge arresters situated on the AC side are damaged.	<ul style="list-style-type: none"> <li>• Observe the inspection window on each surge arrester (AC side). If it is red, the surge arrester is damaged and the cartridge must be replaced.</li> <li>- If the alarm status persists, even if all the surge arresters have a green inspection window, contact customer assistance.</li> </ul>
W021 - P-reductionStart -  No LED	<b>Activation of reduction in power:</b> Indicates that one of the power limitations described in the paragraph "Power limitation messages" has been triggered.	<ul style="list-style-type: none"> <li>• Check which power limitation code is active and, on the basis of that, carry out the necessary checks that might relate to various factors including: <ul style="list-style-type: none"> <li>- settings by the user</li> <li>- high grid frequency</li> <li>- high grid voltage</li> <li>- anti-islanding</li> <li>- low grid voltage</li> <li>- high internal temperature</li> <li>- high input voltage</li> </ul> </li> </ul>
- W022 - Reactive power mode changed -  No LED	<b>Variation in means of managing reactive power:</b> Variation in the means of managing reactive power; this change can be made through the internal webserver.	The variation in the means of managing reactive power is done directly by the customer/installer and is not an error. The information is only saved on the historic record of the events memorised by the inverter
- W023 - date/time changed -  No LED	<b>Variation in the inverter's date and time:</b> Variation of the inverter's date and time; this change can be made through the internal webserver.	<ul style="list-style-type: none"> <li>• The variation in the inverter's date and time is done directly by the customer/installer and is not an error. The information is only saved on the historic record of the events memorised by the inverter</li> </ul>
- W024 - Energy data reset -  No LED	<b>Zeroing of the statistical energy data memorised in the EEPROM:</b> Reset of the energy data saved in the inverter; this operation can be handled through the internal webserver.	The zeroing of the partial energy values memorised by the inverter is done directly by the customer/installer and is not an error. The information is only saved on the historic record of the events memorised by the inverter <ul style="list-style-type: none"> <li>• The warning may also occur when the Memory Card on which the production statistics are saved is replaced</li> </ul>

- Error code - Error message - Warning	Name of Alarm and Cause	Solution
<b>W025</b> - P-reductionEnd - ⊗ No LED	<b>Deactivation of reduction in power:</b> Indicates that the inverter has come out of one of the power limitation states described in the paragraph "Power limitation messages".	This type of warning does not need any check
<b>W026</b> - AFDD user reset - ⊗ No LED	<b>Reset of the Arc Fault error:</b> Manual reset of the Arc Fault error; this operation can be made through the internal webserver.	<ul style="list-style-type: none"> <li>• The reset of the Arc Fault error is done directly by the customer/installer and is not an error. The information is only saved on the historic record of the events memorised by the inverter</li> </ul>
<b>W027</b> - Latch-Manual reset - ⊗ No LED	<b>Resetting of the Latch alarm conditions:</b> Manual reset of the Latch alarm conditions; this operation can be made through the internal webserver.	<ul style="list-style-type: none"> <li>• The reset of the Latch alarm conditions is done directly by the customer/installer and is not an error. The information is only saved on the historic record of the events memorised by the inverter</li> </ul>
<b>W030</b> - Energy Meter ERROR * - ⊗ No LED	<b>METER device communication problem:</b> Error detected on the RS485 serial communication line between the inverter and the energy meter (METER).	<ul style="list-style-type: none"> <li>• Check the serial communication line connections between the inverter and the METER. Particularly check the signal correspondence, the correct installation of the conductors and that there are no breaks in the cables.</li> <li>• Faulty communication card (Comm. card)</li> <li>• Error inside the inverter and cannot be checked externally.</li> <li>- If the problem persists (once the inverter has been switched off and back on again), contact customer assistance.</li> </ul>
<b>W045</b> - Sys disconnected - ● Yellow LED	<b>Disconnection of system from grid:</b> Warning of disconnection of system from electrical grid (no DC input voltage) because of dead battery pack or no demand from domestic loads	<ul style="list-style-type: none"> <li>• Check that, when the warning occurs, the battery pack is dead and/or there have been no energy demands from domestic loads for more than 10 minutes.</li> </ul>
<b>W046</b> - Grid conn. fault - ● Yellow LED	<b>Connection to the grid unsuccessful</b> The alarm is logged when a Missing grid or Input UV error occurs or due to the manual disconnection of the inverter during the grid connection sequence.	<ul style="list-style-type: none"> <li>• Once the error occurs, the inverter tries to return to normal operation.</li> <li>If the problem persists after a number of attempts to connect the inverter, switch the inverter off and then on again.</li> <li>- If the problem persists (once the inverter has been switched off and back on again), contact customer assistance.</li> </ul>
<b>W047</b> - Update Incomplete - ● Yellow LED	<b>FW update method unsuccessful</b> The alarm occurs when a firmware update has not been completed.	<ul style="list-style-type: none"> <li>• Complete any pending firmware updates.</li> <li>- If the problem persists once the firmware updates have been completed, switch the inverter off and on again.</li> <li>- If the problem persists (once the inverter has been switched off and back on again), contact customer assistance.</li> </ul>
<b>W048</b> - Periodic GridOff - ● Yellow LED	<b>Automatic disconnection from the grid due to time limit:</b> If the inverter exceeds the set grid connection time limit set by the grid standard, it will automatically have to carry out a disconnection and reconnection to the grid to carry out the Riso test.	<ul style="list-style-type: none"> <li>• The presence of this alarm is not an error as the automatic disconnection is prescribed by safety regulations.</li> <li>- If the inverter disconnects in a shorter time than expected, contact customer assistance.</li> </ul>
<b>W049</b> - Global-Settings Event - ⊗ No LED	<b>Variation of the grid standard</b> Variation of the inverter's grid standard; this change can be made through the internal webserver.	<ul style="list-style-type: none"> <li>• The variation in the inverter's grid standard is done directly by the customer/installer and is not an error. The information is only saved on the historic record of the events memorised by the inverter</li> </ul>
<b>W058</b> - System Frozen - ● Yellow LED	<b>Converter in locked state:</b> The converter lock state is connected to an installation phase in which the starts-up and grid connection conditions are not yet present.	<ul style="list-style-type: none"> <li>• Complete the commissioning phase of the inverter.</li> <li>- If the problem persists (once the commissioning phase has been completed and the inverter has been switched off and back on again), contact customer assistance.</li> </ul>
<b>E001</b> - Input OC - ● Yellow LED	<b>Input over-current (photovoltaic generator):</b> The alarm occurs when the inverter's input current exceeds the inverter's threshold for maximum input current.	<ul style="list-style-type: none"> <li>• Check whether the composition of the PV generator enables input current which exceeds the maximum threshold allowed by the inverter and that the configuration of the inputs (independent or in parallel) is carried out correctly.</li> <li>- If both checks are positive, contact customer assistance.</li> </ul>
<b>E002</b> - Input OV - ● Yellow LED	<b>Input overvoltage (photovoltaic generator):</b> The alarm is generated when the input voltage (from the PV generator) exceeds the inverter's threshold of maximum input voltage. The alarm is triggered before reaching the absolute threshold beyond which the inverter will be damaged. When the inverter's input voltage exceeds the Over Voltage threshold, the inverter will not start up due to the generation of the alarm.	<ul style="list-style-type: none"> <li>• It is necessary to measure the input voltage inside the inverter with a voltmeter.</li> <li>- If it is higher than the maximum voltage of the operating range, the alarm is genuine and it is necessary to check the configuration of the PV generator. If the voltage has also exceeded the maximum input threshold the inverter could be damaged.</li> <li>- If it is lower than the maximum voltage of the operating range, the alarm is caused by an internal malfunction and it is necessary to contact customer assistance.</li> </ul>

- Error code - Error message - Warning	Name of Alarm and Cause	Solution
- E003 - No Parameters - Yellow LED	<b>DSP initialisation error:</b> The main microcontroller is unable to correctly initialize the two DSPs (booster stage and inverter stage). The error is caused by communication problems on the inverter's internal bus.	<ul style="list-style-type: none"> <li>• Error inside the inverter and cannot be checked externally.</li> <li>- If the problem persists (once the inverter has been switched off and back on again), contact customer assistance.</li> </ul>
- E004 - Bulk OV - Yellow LED	<b>"Bulk" over-voltage (DC-DC circuit):</b> Error inside the inverter. The alarm is raised when the voltage at the heads of the bulk capacitors exceeds the Over Voltage threshold (internal unchangeable threshold).	<ul style="list-style-type: none"> <li>• The alarm may be triggered by causes external to the inverter: <ul style="list-style-type: none"> <li>- An excessive input voltage can be recorded as a condition for bulk over voltage. In this case it is advisable to check the inverter's input voltage and should this value be close to the input OV threshold, review the configuration of the photovoltaic generator.</li> <li>- Excessive grid voltage could cause the bulk voltage to rise in uncontrolled fashion with a consequent protection intervention and hence generation of the alarm. In these cases the alarm is transitory and the inverter automatically restarts</li> <li>- The alarm may be triggered by causes inside the inverter and in this case it is necessary to contact customer assistance.</li> </ul> </li> </ul>
- E005 - Comm.Error - Yellow LED	<b>Communication error inside the inverter:</b> The alarm occurs when there are communication problems between the control devices inside the inverter.	<ul style="list-style-type: none"> <li>• Error inside the inverter and cannot be checked externally.</li> <li>- If the problem persists (once the inverter has been switched off and back on again), contact customer assistance.</li> </ul>
- E006 - Output OC - Yellow LED	<b>Output overcurrent:</b> The alarm occurs when the inverter's output current exceeds the inverter's threshold for maximum output current.	<ul style="list-style-type: none"> <li>• Error inside the inverter and cannot be checked externally.</li> <li>- If the problem persists (once the inverter has been switched off and back on again), contact customer assistance.</li> </ul>
- E007 - IGBT Sat - Yellow LED	<b>Saturation recorded on the IGBT components:</b> The alarm appears when one of the active devices of the inverter is in saturation state.	Once the error appears, the inverter attempts to resume normal operation. <ul style="list-style-type: none"> <li>- Should the error occur sporadically, it may be caused by a brusque transition of the grid voltage or of the input voltage, but is not due to a malfunction by the inverter.</li> <li>- If the error is connected to an internal fault, it will continue to appear and so it is necessary to contact customer assistance.</li> </ul>
- E009 - Internal error - Yellow LED	<b>Error inside the inverter:</b> Error inside the inverter	<ul style="list-style-type: none"> <li>• Error inside the inverter and cannot be checked externally.</li> <li>- If the problem persists (once the inverter has been switched off and back on again), contact customer assistance.</li> </ul>
- E010 - Bulk Low - Yellow LED	<b>Low "Bulk" voltage (DC-DC circuit):</b> The alarm can be caused by causes external to the inverter: a reduced input voltage on the inverter (just above the activation voltage) but which is not accompanied by a sufficient availability of power from the photovoltaic generator (typical condition of the stages with limited irradiation)	<ul style="list-style-type: none"> <li>- If the error signal occurs sporadically, it may be due to causes external to the inverter (limited irradiation and so limited power availability from the PV generator).</li> <li>- If the problem occurs systematically even in conditions of high irradiation and with input voltage which is significantly higher than the activation voltage, contact customer assistance.</li> </ul>
- E011 - Ramp Fail - Yellow LED	<b>Long wait for "Booster" regime to start:</b> Error internal to inverter relating to start up time for DC-DC circuit regime (Booster)	<ul style="list-style-type: none"> <li>• Error inside the inverter and cannot be checked externally.</li> <li>- If the problem persists (once the inverter has been switched off and back on again), contact customer assistance.</li> </ul>
- E012 - DcDc Fail - Yellow LED	<b>Error in the "Booster" circuit (DC-DC side) recorded by the "Inverter" circuit (DC-AC side):</b> Error inside the inverter regarding the operation of the DC-DC circuit part (Booster).	<ul style="list-style-type: none"> <li>• Error inside the inverter and cannot be checked externally.</li> <li>- If the problem persists (once the inverter has been switched off and back on again), contact customer assistance.</li> </ul>
- E013 - Wrong Mode - Yellow LED	<b>Incorrect configuration of inputs (set in parallel rather than independent):</b> The alarm is generated solely when the inverter is configured with parallel inputs. In this particular configuration the inverter checks the input voltage of each of the two channels and if the two voltages differ by more than 20Vdc, the alarm is raised .	<ul style="list-style-type: none"> <li>• Check that the setting of the "IN MODE" switch is specifically set to "PAR" and that the bridges between the two input channels have been included.</li> <li>- If the configuration of the inverter is correct, check that the input strings have the usual number of standard panels of the usual brand and with the same inclination/orientation.</li> <li>- If both the configuration of the inverter and the characteristics of the PV generator conform with the specifications, contact customer assistance.</li> </ul>

- Error code - Error message - Warning	Name of Alarm and Cause	Solution
- E014 - Over Temp. - Yellow LED	<b>Excessive temperature inside the inverter:</b> External temperature over 60°C. This parameter also depends on the power which the inverter must supply since the measurement of temperatures is done internally and is influenced by the heat dissipated by the components of the inverter itself	<ul style="list-style-type: none"> <li>• Check that the inverter is not exposed to direct sunlight. Wait for the temperatures to which the inverter is exposed to return to the operating range and for the inverter to cool down.</li> <li>- If the problem persists (once the ambient temperature has returned to within the range), contact customer assistance. You must remember to wait for the time necessary to allow the inverter to cool down.</li> </ul>
- E015 - Bulk Cap Fail - Yellow LED	<b>Breakdown recorded on the “Bulk” capacitor:</b> Error inside the inverter regarding a problem in the bulk capacitors.	<ul style="list-style-type: none"> <li>• Error inside the inverter and cannot be checked externally.</li> <li>- If the problem persists (once the inverter has been switched off and back on again), contact customer assistance.</li> </ul>
- E016 - Inverter Fail - Yellow LED	<b>Error in the “Inverter” circuit (DC-AC side) recorded by the “Booster” circuit (DC-DC side):</b> The alarm is generated when a problem is detected in the inverter circuit part (DC/AC).	<ul style="list-style-type: none"> <li>• Error inside the inverter and cannot be checked externally.</li> <li>- If the problem persists (once the inverter has been switched off and back on again), contact customer assistance.</li> </ul>
- E017 - Start Timeout - Yellow LED	<b>Long wait for “Inverter” regime to start up:</b> Error internal to inverter relating to start-up time for the DC-AC circuit regime (Inverter) The alarm can be caused by causes external to the inverter: a reduced input voltage on the inverter (just above the activation voltage) but which is not accompanied by a sufficient availability of power from the photovoltaic generator (typical condition of the stages with limited irradiation)	<ul style="list-style-type: none"> <li>- If the error signal occurs sporadically, it may be due to causes external to the inverter (limited irradiation and so limited power availability from the PV generator).</li> <li>- If the problem occurs systematically even in conditions of high irradiation and with input voltage which is significantly higher than the activation voltage, contact customer assistance.</li> </ul>
- E018 - Ground Fault - Red LED	<b>High leakage current measured on the DC side (photovoltaic generator):</b> The alarm is generated when, during normal operation of the inverter, a leakage current to ground is detected in the DC section of the system. It is also possible that the inverter generates the alarm E018 message also due to AC leakage currents connected to the capacitive nature of the photovoltaic generator compared to ground.	<ul style="list-style-type: none"> <li>• Measure the isolation resistance using a megohmmeter positioned in the photovoltaic array (positive terminal short-circuited at the negative pole) compared to ground. The measurement is strongly influenced by the environmental conditions, so must be made under the same conditions in which the error occurred.</li> <li>- If the value measured is lower than 1 megaohm, a check must be carried out by a technician/installer on the photovoltaic generator to identify and eliminate the problem.</li> <li>- If the value measured is higher than 1 megaohm and the error signal persists, contact customer assistance.</li> </ul>
- E019 - Leak sense.fail - Yellow LED	<b>Failure of test on sensor to measure the leakage current (DC side):</b> Before connecting to the grid the inverter runs a self-test regarding the sensor for the leakage current. The test is carried out by “forcing”, in the sensor of the leakage current, a current with a known value: the microprocessor compares the value read with the known value. The error is generated if the comparison between the read value and the known value during the test does not fall within the allowed tolerance.	<ul style="list-style-type: none"> <li>• Error inside the inverter and cannot be checked externally. By its nature, the alarm only occurs prior to connection to the grid</li> <li>- If the problem persists (once the inverter has been switched off and back on again), contact customer assistance.</li> </ul>
- E020 - Self Test Error 1 - Yellow LED	<b>Failure of the test on the relay of the “Booster” (DC-DC circuit):</b> Before connecting to the grid, the inverter carries out some internal tests. One of these tests concerns the correct operation of the booster relay. The test is carried out by “forcing” the switching of the relay and checking its operation. The error is generated if a problem is found in actuating the relay.	<ul style="list-style-type: none"> <li>• Error inside the inverter and cannot be checked externally. By its nature, the alarm only occurs prior to connection to the grid</li> <li>- If the problem persists (once the inverter has been switched off and back on again), contact customer assistance.</li> </ul>
- E021 - Self Test Error 2 - Yellow LED	<b>Failure of the test on the inverter’s relay (DC-AC circuit):</b> Before connecting to the grid, the inverter carries out some internal tests. One of these tests concerns the correct operation of the inverter relay. The test is carried out by “forcing” the switching of the relay and checking its operation. The error is generated if a problem is found in actuating the relay.	<ul style="list-style-type: none"> <li>• Error inside the inverter and cannot be checked externally. By its nature, the alarm only occurs prior to connection to the grid</li> <li>- If the problem persists (once the inverter has been switched off and back on again), contact customer assistance.</li> </ul>
- E022 - Self Test Error 4 - Yellow LED	<b>Timeout of the tests undertaken on the relays inside the inverter:</b> Execution time for the self-test carried out on the relay of the DC_AC (inverter) circuit too high. It may indicate a problem connected to the aforementioned relays	<ul style="list-style-type: none"> <li>• Error inside the inverter and cannot be checked externally.</li> <li>- If the problem persists (once the inverter has been switched off and back on again), contact customer assistance.</li> </ul>

- Error code - Error message - Warning	Name of Alarm and Cause	Solution
- E023 - DC in error - Yellow LED	<b>Feeding of direct current to grid outside of range:</b> The error is generated if the direct component of the current supplied to the grid exceeds the threshold of 0.5% of the rated operating current. In any case, the inverter does not stop because of the E023 error, but tries to connect to the grid again. The sporadic repetition of the error is a sign of serious grid distortions or sharp irradiation changes, while systematic repetition of the error signal will indicate a breakdown on the inverter	Once the error appears, the inverter attempts to resume normal operation. - Should the error occur sporadically, it may be caused by a brusque transition of the grid voltage or of the input voltage, but is not due to a malfunction by the inverter. - If the error is connected to an internal fault, it will continue to appear and so it is necessary to contact customer assistance.
- E024 - Internal error - Yellow LED	<b>Error inside the inverter:</b> Error inside the inverter	• Error inside the inverter and cannot be checked externally. - If the problem persists (once the inverter has been switched off and back on again), contact customer assistance.
- E025 - Riso Low - Red LED	<b>Low value of isolation resistance:</b> Before connecting to the grid the inverter measures the isolation resistance of the PV generator compared to ground. Should the measurement of the isolation resistance be below 1Mohm, the inverter does not connect to the grid and shows the "Riso Low" error. The causes may be: - Damaged PV panel(s). - Junction box(es) of the panels not correctly sealed, so as to permit infiltration by water and/or humidity; - Problems in connections between panels (not perfectly fit); - Poor quality of cable joints; - Presence in the DC section of unsuitable or damaged overvoltage surge arresters outside the inverter (reduced ignition voltage compared to the characteristics of the strings of the PV generator); - Presence of humidity inside any junction box	• Measure the isolation resistance using a megohmmeter positioned in the photovoltaic array (positive terminal short-circuited at the negative pole) compared to ground. The measurement is strongly influenced by the environmental conditions, so must be made under the same conditions in which the error occurred. - If the value measured is lower than 1 megaohm, a check must be carried out by a technician/installer on the photovoltaic generator to identify and eliminate the problem. - If the value measured is higher than 1 megaohm and the error signal persists, contact customer assistance.
- E026 - Vref Error - Yellow LED	<b>Internal reference voltage outside of range:</b> Wrong measurement of reference voltage inside inverter	• Error inside the inverter and cannot be checked externally. - If the problem persists (once the inverter has been switched off and back on again), contact customer assistance.
- E027 - Error Meas V - Yellow LED	<b>Grid voltage outside of range:</b> Error in the internal measurement of grid voltage (set by law) to have a redundant measurement (2 measurements on the same parameter made by two different circuits)	• Error inside the inverter and cannot be checked externally. - If the problem persists (once the inverter has been switched off and back on again), contact customer assistance.
- E028 - Error Meas F - Yellow LED	<b>Grid frequency outside of range:</b> Error in the internal measurement of the grid frequency (imposed by regulations) to have a measurement redundancy (2 measurements on the same parameter carried out by two different circuits).	• Error inside the inverter and cannot be checked externally. - If the problem persists (once the inverter has been switched off and back on again), contact customer assistance.
- E029 - Mid Bulk OV - Yellow LED	<b>Internal overvoltage on the measurement of the "Mid bulk":</b> Error inside the inverter (only triphase models)	• Error inside the inverter and cannot be checked externally. - If the problem persists (once the inverter has been switched off and back on again), contact customer assistance.
- E030 - Error Meas Ileak - Yellow LED	<b>High leakage current (DC side):</b> - Error on the internal measurement (performed when the inverter is connected to the grid) of the DC side (PV generator) leakage current with respect to ground (required by regulations) to have a measurement redundancy (2 measurements of the same parameter carried out by two independent circuits)	• Error inside the inverter and cannot be checked externally. - If the problem persists (once the inverter has been switched off and back on again), contact customer assistance.
- E031 - Error Read V - Yellow LED	<b>Output relay damaged:</b> Measurement of internal voltage on heads of the output relay outside of range. There is too great a difference in voltage between the input and output of the grid connection relay.	• Error inside the inverter and cannot be checked externally. - If the problem persists (once the inverter has been switched off and back on again), contact customer assistance.
- E032 - Error Read I - Yellow LED	<b>Imbalanced output currents:</b> Measurement of the unbalance in the output voltage (made across the three phases) outside of range (only in three-phase models)	• Error inside the inverter and cannot be checked externally. - If the problem persists (once the inverter has been switched off and back on again), contact customer assistance.

- Error code - Error message - Warning	Name of Alarm and Cause	Solution
- E033 - UTH - Yellow LED	<b>Low ambient temperature:</b> Temperature outside the inverter below -25°C	<ul style="list-style-type: none"> <li>• Wait for the temperatures to which the inverter is exposed to return to the operating range.</li> <li>- If the problem persists, contact customer assistance. You must remember to wait for the time necessary to allow the inverter to warm up.</li> </ul>
- E034 - Interlock fail - Yellow LED	<b>"IGBT" circuitry not ready:</b> Error inside the inverter	<ul style="list-style-type: none"> <li>• Error inside the inverter and cannot be checked externally.</li> <li>- If the problem persists (once the inverter has been switched off and back on again), contact customer assistance.</li> </ul>
- E035* - Remote Off - Yellow LED	<b>Inverter awaiting "remote ON" command:</b> The inverter has been switched off remotely (remote OFF) and remains in waiting state for the signal that will switch it on again (remote ON).	<ul style="list-style-type: none"> <li>• Switch the inverter back on remotely. If the unit does not switch on, disable the remote on/off function and switch the equipment off completely and then switch it on again.</li> <li>- If the problem persists (once the Remote ON/OFF function has been reactivated), contact customer assistance.</li> </ul>
- E036 - Vout Avg error - Yellow LED	<b>Average of the measurements of grid voltage outside of range:</b> The average value of the grid voltage (sampled every 10 minutes) does not fall within the permitted ranges. The grid voltage in the point connected to the inverter is too high. This may be caused by a grid impedance that is too high. In the final stage of the timeout, the inverter limits the power to check whether the grid voltage has stabilised into regular parameters. If this does not happen, the inverter disconnects from the grid	<ul style="list-style-type: none"> <li>• Check the grid voltage in the connection point to the inverter.</li> <li>- If the grid voltage differs from the range due to the conditions of the distribution grid, ask the operator to adjust the grid voltage. If the operator authorises a change to the inverter's parameters, agree the new limits with customer assistance.</li> </ul>
- E037 - Riso Low - Red LED	<b>Low value of the isolation resistance (only with the "Amorphous" mode activated):</b> This error can appear only if the "Amorphous" mode is enabled. This function is enabled only in inverters equipped with grounding kit and is used to monitor the voltage at the ends of the grounding resistor. The error appears when the voltage at the ends of the resistor connected between ground and pole of the photovoltaic generator exceeds 30V for more than 30 minutes or 120V for more than one second.	<ul style="list-style-type: none"> <li>• Check for the presence and correct contact between the two terminals of the grounding resistance installed inside the inverter</li> <li>• Measure the isolation resistance using a megohmmeter positioned in the photovoltaic array (positive terminal short-circuited at the negative pole) compared to ground. The measurement is strongly influenced by the environmental conditions, so must be made under the same conditions in which the error occurred.</li> <li>- If the value measured is lower than 1 megaohm, a check must be carried out by a technician/installer on the photovoltaic generator to identify and eliminate the problem.</li> <li>- If the value measured is higher than 1 megaohm and the error signal persists, contact customer assistance.</li> </ul>
E046 - String self test fail - No LED	<b>Error during the automatic check of the string voltages (only in models with the "fuse-control" board):</b> In some inverter models it is possible to carry out the check test of the polarity of the strings connected to the input (e.g.:TRIO-20.0/27.6kW). This error signal occurs when, during the test stage, an inverted string is recorded	<ul style="list-style-type: none"> <li>• Section the inverter and check the polarity of the string(s) which the inverter has recorded as inverted.</li> <li>- Once all the strings have been correctly connected, activate the system once again; the inverter will once again check the correct polarity of the string inputs at the end of which it will carry out the checks for the grid connection.</li> <li>- If the problem persists (once the inverter has been switched off and back on again), contact customer assistance.</li> </ul>
E049 - AC FF Error - Yellow LED	<b>Error in the "AC feed-forward" circuit:</b> Error inside the inverter	<ul style="list-style-type: none"> <li>• Error inside the inverter and cannot be checked externally.</li> <li>- If the problem persists (once the inverter has been switched off and back on again), contact customer assistance.</li> </ul>
E050 - AFDD Activated - Yellow LED	<b>Arc Fault protection activated:</b> Possible photovoltaic arc detected on the DC side.	<ul style="list-style-type: none"> <li>• If it is the first time this problem has occurred, press the ESC button for 5 seconds and wait for the unit to restart.</li> <li>- If the problem persists (once the inverter has been switched off and back on again), contact customer assistance.</li> </ul>
E051 - Safety mem. Fault - Yellow LED	<b>Error inside the inverter.</b>	<ul style="list-style-type: none"> <li>• Error inside the inverter and cannot be checked externally.</li> <li>- If the problem persists (once the inverter has been switched off and back on again), contact customer assistance.</li> </ul>
E053 - AFDD Fault - Yellow LED	<b>Arc Fault board autotest failed:</b> Problem detected during the AFDD board autotest phase.	<ul style="list-style-type: none"> <li>• Error inside the inverter and cannot be checked externally.</li> <li>- If the problem persists (once the inverter has been switched off and back on again), contact customer assistance.</li> </ul>
E054 - AFDD comm. Fault - Yellow LED	<b>Arc Fault board communication error:</b> Error on the RS485 serial communication detected between the inverter and the AFDD board.	<ul style="list-style-type: none"> <li>• Error inside the inverter and cannot be checked externally.</li> <li>- If the problem persists (once the inverter has been switched off and back on again), contact customer assistance.</li> </ul>
E055 - AFDD wrong conf. - Yellow LED	<b>Arc Fault board parameter reading error:</b> Error in the parameter reading by the system.	<ul style="list-style-type: none"> <li>• Error inside the inverter and cannot be checked externally.</li> <li>- If the problem persists (once the inverter has been switched off and back on again), contact customer assistance.</li> </ul>

- Error code - Error message - Warning	Name of Alarm and Cause	Solution
<b>E056</b> - Over Temp. (from external box) - ● Yellow LED	<b>Excessive temperature measured inside the inverter's wiring box:</b> High internal temperature. This error relates to the temperature measured on external boxes (e.g.:TRIO-20.0/27.6kW).	<ul style="list-style-type: none"> <li>• Check that the inverter is not exposed to direct sunlight. Wait for the temperatures to which the inverter is exposed to return to the operating range and for the inverter to cool down.</li> <li>- If the problem persists (once the ambient temperature has returned to within the range), contact customer assistance. Remember to wait the time needed to allow the inverter to cool down</li> </ul>
<b>E057</b> - Vbulk reading error - ● Yellow LED	<b>Input voltage (Vin) higher than booster voltage (Vbulk):</b> The error occurs if the input voltage exceeds the Bulk voltage (voltage on the DC-DC circuit inside the inverter)	<ul style="list-style-type: none"> <li>• It is necessary to measure the input voltage inside the inverter with a voltmeter.</li> <li>- If it is higher than the maximum voltage of the operating range, the alarm is genuine and it is necessary to check the configuration of the PV generator. If the voltage has also exceeded the maximum input threshold the inverter could be damaged.</li> <li>- If it is lower than the maximum voltage of the operating range, the alarm is caused by an internal malfunction and it is necessary to contact customer assistance.</li> </ul>
<b>E058</b> - Pin vs Pout check error - ● Yellow LED	<b>Error in the check of Pin vs Pout:</b> The error occurs if the difference between the measured value of input power and that of output power is greater than the limit imposed internally to the inverter.	<ul style="list-style-type: none"> <li>• Error inside the inverter and cannot be checked externally.</li> <li>- If the problem persists (once the inverter has been switched off and back on again), contact customer assistance.</li> </ul>
<b>E074</b> - Internal error - ● Yellow LED	<b>Communication error inside the inverter:</b> The alarm occurs when there are communication problems between the control devices inside the inverter.	<ul style="list-style-type: none"> <li>• Error inside the inverter and cannot be checked externally.</li> <li>- If the problem persists (once the inverter has been switched off and back on again), contact customer assistance.</li> </ul>
<b>E077</b> - Internal Error - ● Yellow LED	<b>Error in the system configuration:</b> Error inside the inverter	<ul style="list-style-type: none"> <li>• Error inside the inverter and cannot be checked externally.</li> <li>- If the problem persists (once the inverter has been switched off and back on again), contact customer assistance.</li> </ul>
<b>E078</b> - Riso Test fail - ● Yellow LED	<b>Riso test error:</b> Problem detected during the Riso test phase.	<ul style="list-style-type: none"> <li>• Error inside the inverter and cannot be checked externally.</li> <li>- If the problem persists (once the inverter has been switched off and back on again), contact customer assistance.</li> </ul>
<b>E079</b> - Wrong Sequence - ● Yellow LED	<b>Incorrect Phases connection</b> (Only triphase models) The phases have not been connected correctly to the AC output	<ul style="list-style-type: none"> <li>• Invert two of the phases of the network wiring to the AC terminal block of the inverter.</li> </ul>
<b>E081</b> - Internal Error - ● Red LED	<b>Inverter fault / Incomplete inverter closing:</b> Fault inside the inverter or incomplete inverter closing (front cover missing or not tightened, cable glands missing or incorrectly tightened, environmental protection IP65 not guaranteed)	<ul style="list-style-type: none"> <li>• If the problem has occurred during the installation phase or during the inverter maintenance phase (therefore the cover has been removed or the cable glands have been acted upon), carry out the following operations:              - Disconnect the AC grid and DC input from the inverter and check for the front cover and all the cable glands, also checking their correct tightening to ensure environmental protection IP65; reconnect the AC grid and the DC input and attempt to switch the inverter on; if the problem persists, contact customer assistance :              - If the front cover and all cable glands are present, disconnect the AC grid and DC input from the inverter and wait 15 minutes at a safe distance, then open the inverter cover and if no smoke/smell of burning is present, check the integrity of the components or the presence of moisture or other abnormal conditions; reconnect the AC grid and DC input and attempt to switch on the inverter; if the problem persists contact customer assistance.</li> <li>• If the problem has occurred after installation or after an inverter maintenance phase (therefore the cover has NOT been removed or the cable glands have NOT been acted upon), disconnect the AC grid and the DC input from the inverter and contact customer assistance.</li> </ul>
<b>E084</b> - BackFeed OC - ● Yellow LED	<b>Return current to photovoltaic field:</b> The error occurs if the input voltage is particularly low (typically in the evening in conditions of low irradiation) and indicates a return current from the inverter to the photovoltaic panels).	<ul style="list-style-type: none"> <li>• If the error occurs in the evening or in conditions of low irradiation, it must not be considered a problem but a protection intervention for the photovoltaic field.</li> <li>- If the error occurs with good irradiation conditions, switch the inverter off and back on again; if the error persists, contact customer assistance.</li> </ul>
<b>E103</b> - RSD self-test fault - ● Yellow LED	<b>RSD self-test fault:</b> RSD functionality is damaged	<ul style="list-style-type: none"> <li>• Error inside the inverter and cannot be checked externally.</li> <li>- If the problem persists (once the inverter has been switched off and back on again), contact customer assistance.</li> </ul>

## Power limitation messages

The equipment can signal possible output power limitations which may occur on the basis of:

- settings made by the user
- settings required by the grid standard of the country of installation
- protective devices inside the inverter

The signals and the messages can only be verified using the internal Webserver.

*The following table gives the complete list of power limitation messages relating to string inverters.*

*Some messages may not be used depending on the inverter model installed.*

- Limitation code	Name of Derating and Cause	Solution
- LIMxxx% CODE:00	<p><b>Power limitation:</b> The message indicates that the user has set an output power limitation for the inverter. LIM xxx% = Power reduction percentage Examples: LIM 100% = no power limitation LIM 50% = limitation to 50% of the output nominal power</p>	<ul style="list-style-type: none"> <li>• Check the limitation value in “Settings &gt; Power Reduction”.</li> </ul>
- LIMxxx% CODE:01	<p><b>Power limitation for over-frequency:</b> The message indicates that the user has set a power limitation due to over frequency in order to reduce the maximum output power of the inverter when the grid frequency exceeds certain limits. LIM xxx% = Power reduction percentage Examples: LIM 100% = no power limitation LIM 50% = limitation to 50% of the output nominal power</p>	<ul style="list-style-type: none"> <li>• Check the limitation value set in “Settings &gt; Service Power &gt; OF Derating”</li> </ul>
- LIMxxx% CODE:02	<p><b>Power limitation for over-voltage:</b> The message indicates that the user has set a power limitation due to overvoltage (parameter U &gt;(10 min)) in order to reduce the maximum output power of the inverter when the reading of the average grid voltage exceeds certain limits. The sampling of readings is done every 10 minutes (U&gt;(10min)). LIM xxx% = Power reduction percentage Examples: LIM 100% = no power limitation LIM 50% = limitation to 50% of the output nominal power</p>	<ul style="list-style-type: none"> <li>• Check the limitation value in “Settings &gt; Service Power &gt; U&gt;(10min) Der.”</li> </ul>
- LIMxxx% CODE:03	<p><b>Anti-islanding power limitation:</b> The message indicates that a power limitation is active since an "islanding" condition has been recorded. LIM xxx% = Power reduction percentage Examples: LIM 100% = no power limitation LIM 50% = limitation to 50% of the output nominal power</p>	<ul style="list-style-type: none"> <li>• If the inverter remains connected to the grid and the limitation is active, contact customer assistance</li> </ul>
- LIMxxx% CODE:04	<p><b>Power limitation due to low grid voltage:</b> The message indicates that an output power limitation may occur since a low grid voltage (AC) condition has been recorded. LIM xxx% = Power reduction percentage Examples: LIM 100% = no power limitation LIM 50% = limitation to 50% of the output nominal power</p>	<ul style="list-style-type: none"> <li>• Check that the grid voltage is lower than the minimal voltage. Should this condition persist, contact the grid operator to resolve the problem.</li> </ul>



- Limitation code	Name of Derating and Cause	Solution
- LIMxxx% CODE:05	<p><b>Power limitation due to excess temperature:</b>            The message indicates that a power limitation is active since an excess temperature condition has been recorded inside the inverter (This parameter depends also on the power which the inverter must provide since the measurement of temperatures is taken internally and is influenced by the heat dissipated by the components of the inverter itself).            LIM xxx% = Power reduction percentage            Examples:            LIM 100% = no power limitation            LIM 50% = limitation to 50% of the output nominal power</p>	<ul style="list-style-type: none"> <li>• Check that the inverter is not exposed to direct sunlight. Wait for the temperatures to which the inverter is exposed to return to the operating range and for the inverter to cool down.</li> <li>- If the problem (once the ambient temperature has returned within the range) persists, contact customer assistance.</li> </ul>
- LIMxxx% CODE:06	<p><b>Power limitation for input over-voltage:</b>            The message indicates that a power limitation is active since an input overvoltage (AC) has been recorded.            LIM xxx% = Power reduction percentage            Examples:            LIM 100% = no power limitation            LIM 50% = limitation to 50% of the output nominal power</p>	<ul style="list-style-type: none"> <li>• It is necessary to measure the input voltage inside the inverter with a voltmeter.</li> <li>- If it is higher than the maximum voltage of the operating range, the alarm is genuine and it is necessary to check the configuration of the PV generator. If the voltage has also exceeded the maximum input threshold the inverter could be damaged.</li> <li>- If it is lower than the maximum voltage of the operating range, the alarm is caused by an internal malfunction and it is necessary to contact customer assistance.</li> </ul>

## Procedure for dismantling the Inverter

To dismantling and disassemble the appliance, refer to the chapters:  
**“Mounting on a vertical or horizontal support”**

Follow the indications for the mounting procedure but in the reverse order



*Perform the steps for “Inverter total de-energization and safe access” based on the model, before removing one of the two wiring boxes or the inverter itself.*

*Never open the wiring boxes in the case of rain, snow or a level of humidity >95%.  
Always carefully seal all unused openings.*

Even though the device is equipped with an anti-condensation valve, air with extremely high levels of humidity can lead to the creation of condensation inside the inverter.

As the inverter is almost completely insulated from the outside, condensation can also form after maintenance interventions in certain weather conditions.



*During dismantling must be installed caps on interface quick connectors on the inverter parts that are installed and exposed to the elements.*

## Registration on “Registration” website and calculation of security token (Admin Plus)

In order to obtain the security token needed to obtain the “Admin Plus” privileges in the web user interface, it is necessary to go through the following stages:

### Stage 1 - Collection of information relating to the inverter.

Collect the following information relating to each inverter for which you wish to have the security token:

- **S/N** - Serial number of the inverter. This information can be found on the product label giving the identity details of the inverter.

The serial number consists of 6 digits (the last 6 in models with a label giving a 10-digit S/N).

- **WK** - Production week. This information can be found on the product label giving the identity details of the inverter.

The production week consists of 4 figures, indicating the week (first 2 digits) and the year of production (last 2 digits).

### Stage 2 - Registration on <https://registration.solar.fimer.com>

- Go online and access <https://registration.solar.fimer.com>
- Set the desired language and click on the specific icon to start registration

- Insert the personal data requested and end the registration stage
- An email will be sent to the email address used with a link to complete the registration process.
- Once the registration process is over, a further email will be sent with the password to access the website.



*The security token obtained enables access also to the advanced “Installer” mode present on the configuration software for inverters. The configuration software can be downloaded in a specific section of the website <https://registration.solar.fimer.com>*

### Stage 3 - Request for the security token

- Go online and access <https://registration.solar.fimer.com>
- Insert the Username (corresponding to the email used during registration) and the Password obtained at the end of Stage 2

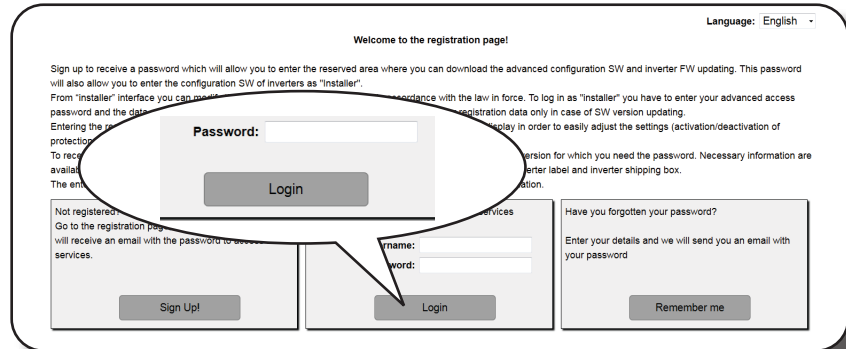

- Access the section dedicated to requesting the security token

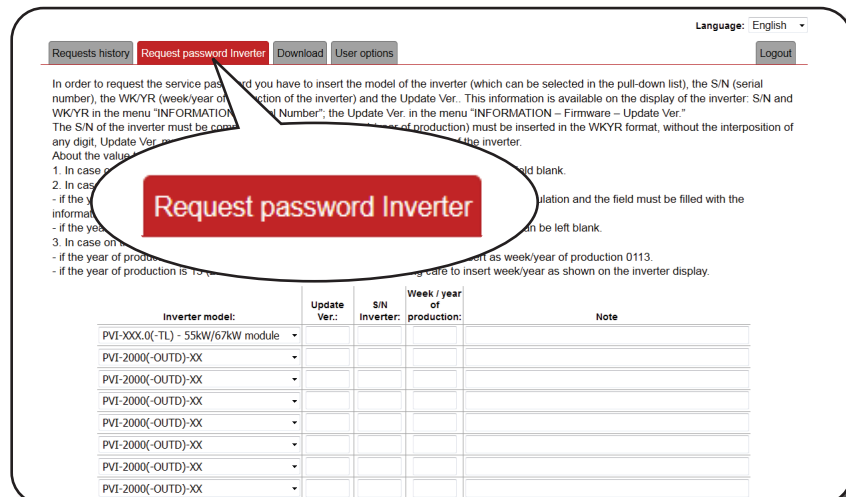

- Choose the inverter model from the drop-down list and insert Serial Number and Week of Production of the inverter which were obtained previously (Stage 1)

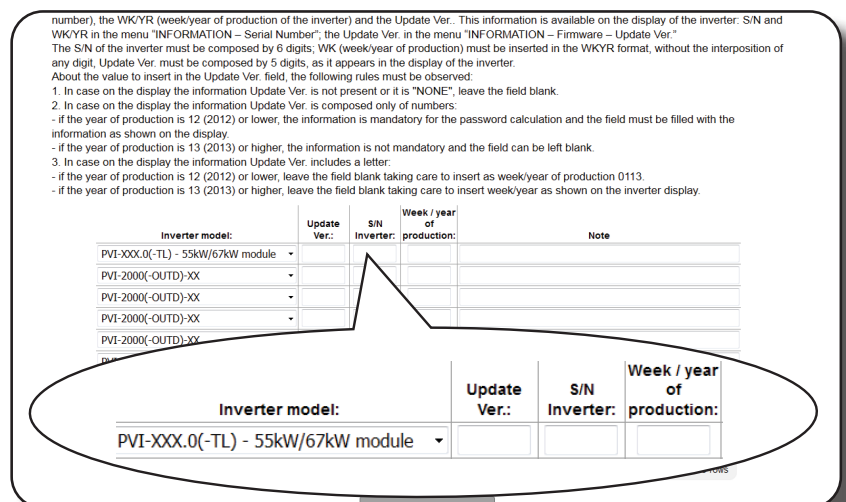

- Click on icon to request the security token.

Language: English

Requests history **Request password inverter** Download User options Logout

In order to request the service password you have to insert the model of the inverter (which can be selected in the pull-down list), the S/N (serial number), the WK/YR (week/year of production of the inverter) and the Update Ver.. This information is available on the display of the inverter: S/N and WK/YR in the menu "INFORMATION – Serial Number"; the Update Ver. in the menu "INFORMATION – Firmware – Update Ver."  
 The S/N of the inverter must be composed by 6 digits, WK (week/year of production) must be inserted in the WK/YR format, without the interposition of any digit, Update Ver. must be composed by 5 digits, as it appears in the display of the inverter.  
 About the value to insert in the Update Ver. field, the following rules must be observed:

- In case on the display the information Update Ver. is not present or it is "NONE", leave the field blank.
- In case on the display the information Update Ver. is composed only of numbers:
  - if the year of production is 12 (2012) or lower, the information is mandatory for the password calculation and the field must be filled with the information as shown on the display.
  - if the year of production is 13 (2013) or higher, the information is not mandatory and the field can be left blank.
- In case on the display the information Update Ver. includes a letter:
  - if the year of production is 12 (2012) or lower, leave the field blank taking care to insert as week/year of production 0113.
  - if the year of production is 13 (2013) or higher, leave the field blank taking care to insert week/year as shown on the inverter display.

Inverter model:	Update Ver.:	S/N Inverter:	Week / year of production:	Note
PVI-XXX.0(-TL) - 55KW/67KW module		123456	1117	
PVI-2000(-OUTD)-XX				
PVI-2000(-OUTD)-XX				
PVI-2000(-OUTD)-XX				
PVI-2000(-OUTD)-XX				
PVI-2000(-OUTD)-XX				
PVI-2000(-OUTD)-XX				
PVI-2000(-OUTD)-XX				
PVI-2000(-OUTD)-XX				
PVI-2000(-OUTD)-XX				
PVI-2000(-OUTD)-XX				
PVI-2000(-OUTD)-XX				

Add other 10 rows

Do request

Should there be an error in inputting data, the fields containing the error will be highlighted in red. If, on the other hand, the data are correct, the passwords will be shown in a new window and at the same time sent to the email address used for registration.



*The security token enables the "Admin Plus" privileges which allows the inverter's sensitive parameters to be changed. Proceed to changing the aforementioned parameters only when requested by the grid operator or by customer assistance.*

## Replacing DC string fuses



Some inverter parts may be subject to voltages that could be hazardous for the operator. Before performing any work on the inverter, refer to “Inverter total de-energization and safe access” chapter on this manual to know all the necessary step to safely operate on the inverter.

The string protection fuses (where present) in the inverter may need to be replaced in the following circumstances:

1. Adjustment of the fuse value on the basis of the type of PV panels used
2. Damaged fuse

• Procedure for replacing string fuses from positive **35** or negative **34** (only -SC model) string fuses board:

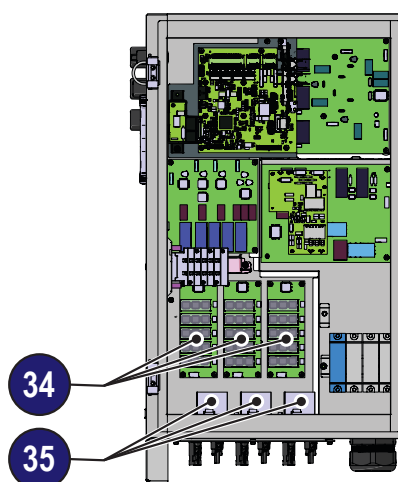

1. Open any AC disconnect switch downstream of the inverter.
2. Open the DC disconnect switches **15**



**By only disconnecting the AC disconnect switch and the DC disconnect switch, the DC input voltage is still present on the fuse board. Use adequate PPE (personal protective equipment).**

3. Disconnect the strings by disconnecting the quick fit input connectors **19** **20** **21**.
4. Wait enough time for the stored energy to be discharged (min time 30 minutes).
5. Open the wiring box front cover **04**
6. Remove the fuse to be replaced
7. Introduce the new fuse into the fuse holder on the string fuse boards

- Procedure for replacing string fuses from positive or negative in the fuse holders IN1,IN2,IN3 (only on -S model):

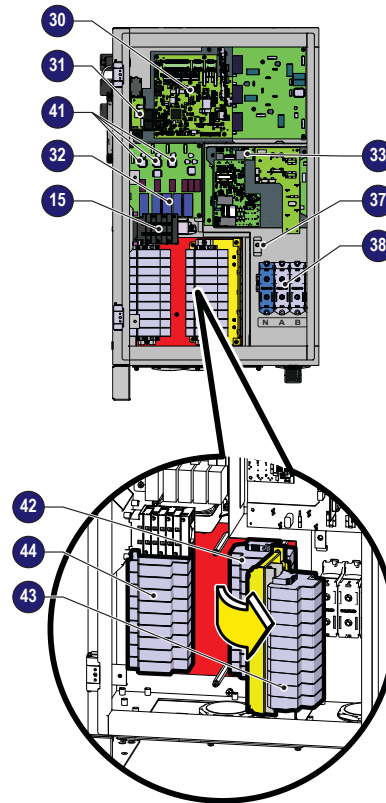

1. Open any AC disconnect switch downstream of the inverter.
2. Open the DC disconnect switches **15**



***By only disconnecting the AC disconnect switch and the DC disconnect switch, the DC input voltage is still present on the fuse board. Use adequate PPE (personal protective equipment).***

3. Wait enough time for the stored energy to be discharged (min time 30 minutes).
4. Remove the string from fuses terminal block related to the open fuse, and isolate it with appropriated insulation cup.
5. Open the wiring box front cover **04**
6. Remove the fuse to be replaced
7. Introduce the new fuse into the fuse holder on the string fuse boards

## Replacing cooling section



Some inverter parts may be subject to voltages that could be hazardous for the operator. Before performing any work on the inverter, refer to “Inverter total de-energization and safe access” chapter on this manual to know all the necessary step to safely operate on the inverter.

Procedure for replacing cooling section:

1. Perform the “inverter total de-energization and safe access” procedure before operate on the inverter
2. Remove the 6 screws of the cooling section.

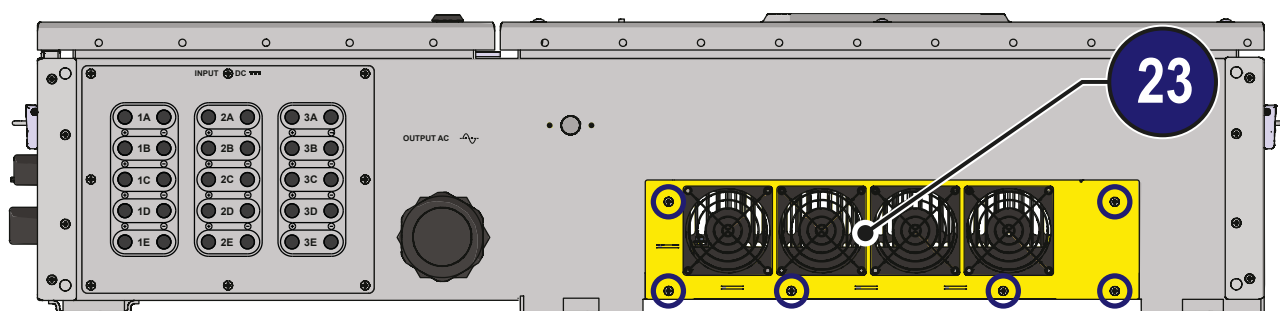

3. Pull out the cooling section

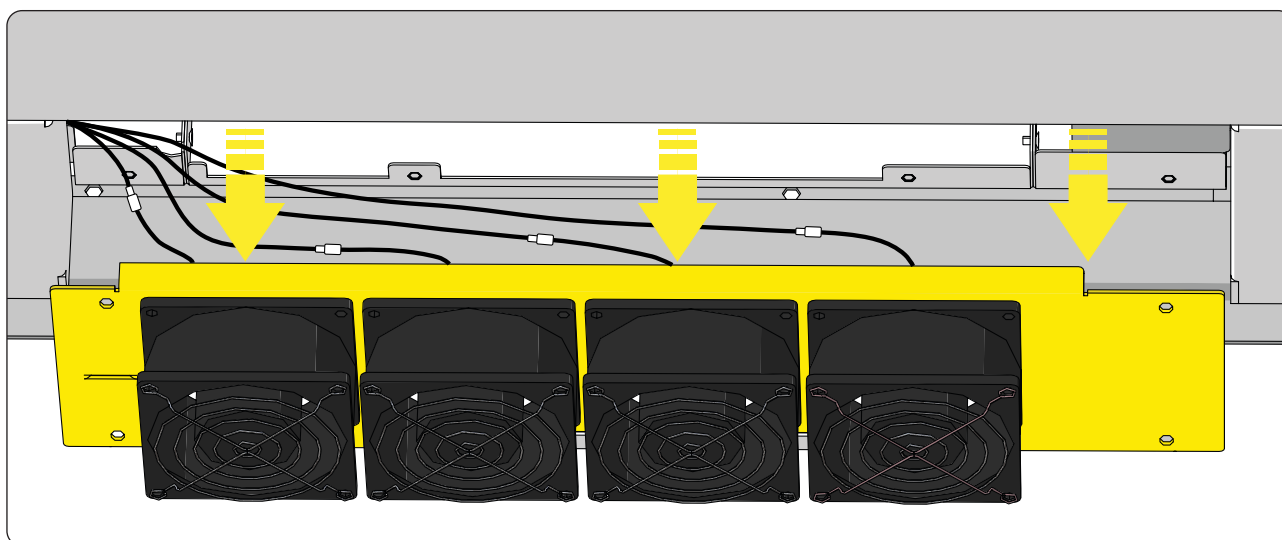

4. Disconnect the fan connectors
5. Take the new cooling section and connect the 4 fan connectors. During this phase pay attention to connect the fan to the correspondent cable (the cables have different length based on the fan position).
6. Place the new cooling section on the lower side of the inverter
7. Screw the 6 fastening screws



## Replacement of the buffer battery



Some inverter parts may be subject to voltages that could be hazardous for the operator. Before performing any work on the inverter, refer to “Inverter total de-energization and safe access” chapter on this manual to know all the necessary step to safely operate on the inverter.

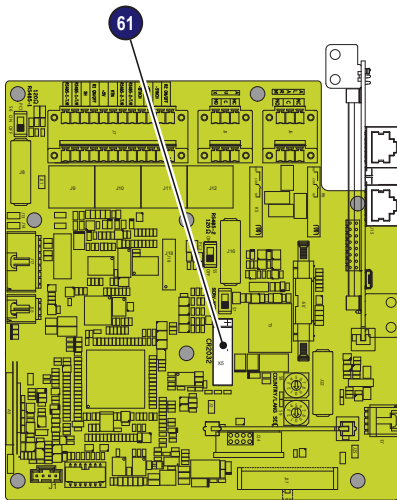

Replacing the buffer battery **61** is carried out on the wiring box and may be necessary in the following circumstances:

1. LED error signal
2. Reset of the date and time settings

The battery is of the **CR2032 type** and is installed on the communication and control board **30**.

Procedure to replace the buffer battery **61**:

1. Open any AC disconnect switch of the inverter.
2. Open any DC disconnect switch:
  - Upstream of the inverter on -Standard model.
  - Open the DC disconnect switch **15** on -Standard, -S and -SC model.

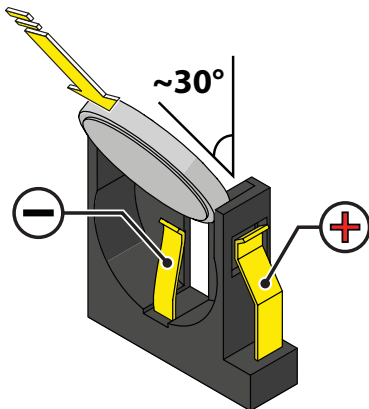

3. Disconnect the quick fit input connectors on -SC model.
4. Wait 30 minutes before open the wiring box front cover **04**.
5. Remove the buffer battery **61** to be replaced

6. Install the new battery, taking care to handle it with insulating gloves in order not to compromise the charge and respecting the polarity shown on the diagram on the communication and control board **30**

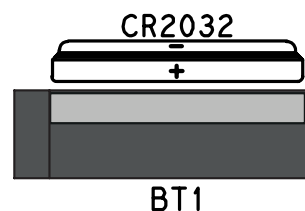

7. Reconnect all the input strings and start the inverter.

## Storage and dismantling

### Storage of an uninstalled inverter for long periods

If the inverters to be stored for a long period of time before installation, check that it is correctly packed.

The equipment must be stored in well-ventilated, indoor areas, in a non-corrosive environment that doesn't damage the inverter's components.

Have the inverter inspected before installation: interior components, covers and gaskets.

### Storage of an installed inverter for long periods of non-use

If an inverter in the field is to be left unused, confirm all external openings and connectors have water tight seals or cap. Securely close all locks. If it's in a humid environment, install dessicant in the interior since the inverter is not seeing heat cycles each day.

Restarting after a long period of non-use requires a thorough inspection of the inverter's interior, exterior and wiring to the PV field and grid (and removal of any dessicant). In some cases, oxidation and dust that has settled inside the equipment must be removed.

## Disposal

FIMER CANNOT be held responsible for disposal of the equipment (cables, batteries, etc.). The customer must dispose of these items, some of which be harmful to the environment, in accordance with the local regulations

Dispose of the various types of materials at facilities that are suitable for the purpose.

### Table: component composition

COMPONENT	CONSTRUCTION MATERIAL
Frame, brackets, supports .....	Arc-welded steel FE37
Casing or covers .....	Arc-welded steel FE37, aluminum
Gaskets and seals .....	Rubber / Teflon / Viton
Electrical cables .....	Copper / Rubber
Backup battery .....	Nickel / Lead/ Lithium

## Port and network services used by the inverter

### IP Network Services

Any network connected to the inverter must allow traffic to pass on the following ports. Network firewall rules (if present) must allow responses to the inverter over existing TCP connections.

Direction	Service/Port	Protocol	Description
In	ssh/22	Tcp	For local debugging by FIMER service personnel, the inverter utilizes encrypted SSH. To allow service personnel local access to the inverter.
Out	domain/53	Tcp/udp	The inverter must be able to resolve domain names, to ensure scalability and dynamic changes on the Internet (DNS). (required)
Out	https/443	Tcp	As an HTTP client, the inverter uses SSL/TLS protocol connections to Aurora Vision® servers for secure communication. The inverter uses this port for all services, including data transmission, firmware upgrade, configuration management, and remote command transmission. (required)
Out	dhcp/67, dhcp/68	Udp	If DHCP service is not available, static network information must be assigned to the inverter (preferred)
Out	ntp/123	Udp	The inverter uses this port for network time services (NTP). (preferred)
Out	modbus/502	Tcp	The inverter offer a Modbus TCP server connection on this port.
Out	dns-sd/5353	Udp	The inverter uses this protocol to resolve the local IP address.
Out	http/80	Tcp	As an HTTP client, the inverter uses this protocol to offer local connection.

## Network Hosts

The inverter will connect to the following hosts. Some servers owned by FIMER, and others are customer or ISP servers. Servers listed as owned by "Customer IT/ISP" must be configured in the inverter using either DHCP or as static network information.

Host	Purpose	Port	Owner/Manager
platform.auroravision.net	Data, configuration	TCP:443	FIMER
gw1.auroravision.net and/or apt.fatspaniel.net	Inverter firmware upgrade	TCP:443	FIMER
Site dependent	DHCP (optional)	UDP:67, UDP:68	Customer IT/ISP
Site dependent	DNS	UDP:53, TCP:53	Customer IT/ISP

## Inverter network configuration

The inverter requires a valid network configuration in order to operate. This information can either be provided by a DHCP server provided by the customers network (the default), or the inverter can be configured with static network information. Regardless of how the inverter is configured, the following information is required.

Configuration	Purpose
IP Address	Allows the inverter to take part in the local network. This does not need to be a public IP address. In most cases this is a private IP address.
Subnet mask	Used to determine if two computers are on the same network.
Gateway	The IP address of the computer which will forward network traffic from the local network to an external network
DNS Server	The IP address(es) of the computer(s) which resolve domain names.

## Contact us

[www.fimer.com](http://www.fimer.com)



For more information  
please contact  
your local FIMER  
representative or visit:

[fimer.com](http://fimer.com)

We reserve the right to make technical changes or modify the contents of this document without prior notice. With regard to purchase orders, the agreed particulars shall prevail. FIMER does not accept any responsibility whatsoever for potential errors or possible lack of information in this document.

We reserve all rights in this document and in the subject matter and illustrations contained therein. Any reproduction, disclosure to third parties or utilization of its contents – in whole or in parts – is forbidden without prior written consent of FIMER. Copyright© 2021 FIMER. All rights reserved.