

The FIMER logo consists of the word "FIMER" in a bold, white, sans-serif font, centered within a solid red rectangular background. To the right of the red rectangle is a smaller, light grey rectangular block.

**FIMER**

**Inverter for Life**



**USER MANUAL for SOLAR INVERTER:  
R5010TL – R10000TL**



## Inverter for Life

Via J.F. Kennedy  
20871 Vimercate (MB) Italy  
Phone: +39 039 98981  
Fax +39 039 6079334

**www.fimer.com**  
solar@fimer.com



INFOLINE  
Tel. +39-039-6079326

**Istruzioni Originali**

**Original instructions**

**Übersetzung der Originalbetriebsanleitung**

**Notice originale**

**Manual original**



# INDEX

1. GENERAL INFORMATION .....	5
1.1 Manufacturer's address .....	5
1.2 Information on electromagnetic compatibility.....	5
1.3 Information on the manual .....	5
1.4 Environmental impact declaration .....	5
2. INTRODUCTION .....	6
3. GENERAL INFORMATION .....	7
3.1 Symbols used in the manual.....	7
4. SAFETY INSTRUCTIONS AND OTHER WARNINGS .....	8
5. TECHNICAL SPECIFICATIONS OF THE INVERTER.....	16
6. DECLARATION OF CONFORMITY .....	17
7. INVERTER BLOCK DIAGRAM .....	18
8. DESCRIPTION OF OPERATING PRINCIPLE.....	20
8.1 Introduction.....	20
8.2 Start-up.....	21
8.3 Production .....	21
9. STORAGE .....	22
10. INSTALLATION AREA.....	22
11. PRELIMINARY OPERATIONS .....	22
11.1 Packaging Inspection .....	22
11.2 Handling.....	23
11.3 Positioning .....	24
12 PREPARATION OF THE ELECTRICAL SYSTEM.....	25
12.1 System protections .....	25
12.2 Connections of the photovoltaic array and the electricity grid .....	25
12.3 Connections for signals, remote contacts and EPO (Emergency Power Off) circuit .....	31
13. INITIAL START-UP.....	34
14. AUTOMATIC START .....	35
15. OPERATION.....	35
15.1 Home page .....	35
15.2 Fault signals .....	36
15.3 Measurements .....	36
15.4 Alarms.....	38
15.5 Inverter.....	39
15.6 Configuration .....	40
15.6.1 Communication.....	40
15.6.2 String Box .....	41
15.6.3 Datalogger.....	41
15.6.4 Settings.....	41
15.6.5 String Inverter .....	42
15.6.5.1 FIMER Series R addresses.....	42
15.6.5.2 FIMER Series C addresses.....	42
15.6.6 Thresholds.....	43
15.6.7 Alarms.....	43
15.6.8 Alarm Send .....	44
16. TURNING OFF .....	45
17. Maintenance .....	45
18. MECHANICAL DIMENSIONS .....	45
19. MACHINE CONNECTIONS.....	48
20. COOLING AIR FLOW AND CIRCULATION.....	52

ANNEX 1: Technical specifications of the AC and DC surge arresters .....	53
SPD on DC side .....	53
SPD on AC side .....	56
ANNEX 2: Notes on the design and dimensioning of MV / LV transformers.....	59
ANNEX 3: Preventive and periodic maintenance of central inverters .....	60
ANNEX 4: Troubleshooting .....	65
ANNEX 5: Norms and requirement for connecting the inverter to the national grid and parameter setting .....	70
Parameter Setting .....	70
Centralized control of the operation of the inverter .....	72
Limit of the power in the centralized logic .....	72
Trigger for setting the curve Q(V) in centralized logic .....	72
Reactive power requirement in centralized logic.....	72
Control in local logic.....	73
Setting of the connecting parameter.....	73
Limit of the feed-in power according to the grid frequency P(f).....	73
Generation of reactive power according to the grid voltage Q(V) .....	75
Generation of reactive power according to the grid power Q(P) .....	76
Reaction to the LVFRT fault of the grid.....	77

# 1. GENERAL INFORMATION

Document Title: **USER MANUAL for SOLAR INVERTER: R5010TL–  
R10000TL**

Document Classification: **User and Installation Manual  
ORIGINAL INSTRUCTIONS**

## **1.1 Manufacturer's address**

**FIMER S.p.A**

**Via J.F. Kennedy - 20871 Vimercate – (MB) - Italy**

**Tel. +39 039 98981 r.a. - Fax +39 039 6079334 - [www.FIMER.com](http://www.FIMER.com) - [solar@FIMER.com](mailto:solar@FIMER.com)**

## **1.2 Information on electromagnetic compatibility.**

### **Attention:**

This product can only be sold to qualified installers. To prevent disturbances, installation restrictions or additional measures may be necessary.

## **1.3 Information on the manual**

© Copyright – FIMER S.p.A. – All rights reserved

This publication is the exclusive property of FIMER. This manual is given to purchasers of our equipment and to instruct and inform end users. The technical contents, illustrations and anything else contained in this manual are to be treated as confidential and no part may be reproduced without specific authorisation by FIMER. Technicians and end users may not divulge the information contained herein or use this manual for purposes other than those strictly connected to the correct use of the equipment.

FIMER shall not assume any liability for any damages caused by its improper use, the same applies to people or companies involved in the preparation or production of this manual. The product specifications are subject to change without notice. The images are only indicative.

## **1.4 Environmental impact declaration**

The grid-connected solar inverters manufactured by FIMER offer lower consumption of raw materials and lower amounts of waste throughout their working life. In typical applications, these positive effects on the environment far outweigh the negative impacts of the manufacturing of the products and final disposal.

The packaging of the products is of a good quality and can be reused. All the products are placed inside sturdy cardboard and wooden boxes, which are themselves made with a high percentage of fibre and recycled materials. If not reused, the packaging can be recycled. Polyethylene used to make the protective film and bags for wrapping the products can be recycled for the same purpose. The packaging strategy adopted by FIMER is based on easily recyclable products with low environmental impact and, thanks to regular controls and analysis, aims at identifying new improvement opportunities in this area.



At the end of their life and operation, the inverters can be dismantled very easily by separating the main components which can then be recycled. Some parts of these devices are snap-locked to each other and therefore can be separated without the use of tools, while many other components are secured with normal screws and therefore can be easily disassembled with the use of common screwdrivers. In any case, virtually every part of the product is recyclable. Do not dispose of the device or its parts with household waste. In accordance with European Directive 2012/19/UE on electric and electronic waste and its application in national law (i.e. Italian Dls 14 March 2014 n° 49), used electronic devices must be collected separately and recovered ecologically. The device must be disposed of in compliance with the collection and disposal system adopted and authorised in your area. Failure to comply with this EU Directive may adversely affect the environment and human health!

## **2. INTRODUCTION**

Dear Customer,

Congratulations on choosing our photovoltaic inverter, whose characteristics of high technology and reliability coming from the design and quality control system make it a highly innovative and durable product.

This manual contains all the information necessary to install and use the product safely. It is recommended to carefully read its contents before connecting and operating the machine. Proper use of the product guarantees the reliability and quality of the system over time, which is indispensable to obtain excellent performances and outputs.

The contents of the manual will help you resolve most doubts and problems. Do not hesitate to contact your usual installer, distributor or sales representative if you experience problems during the use and installation which are not clearly described or documented in the manual. To obtain the latest information on the product or the latest version of the manual, please visit our website.

Keep this manual in a safe place near the machine for quick reference.







This manual is an integral part of the machine; in case of resale of the inverter, this manual should also be given to the purchaser.

The manual must always accompany the inverter each time it is moved.

Thanks again for choosing our solar inverter.

### 3. GENERAL INFORMATION

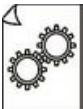
#### 3.1 Symbols used in the manual

	INFORMATION: It is recommended that the user carefully considers what is described and pays attention to the instructions contained in the manual.
	CAUTION or DANGER: The user is asked to pay the utmost attention to what is described in order to prevent the occurrence of situations that may cause serious damage or malfunctions to the equipment, as well as accidents, injuries or death to people.
	RISK OF ELECTRIC SHOCK: It is compulsory to follow the instructions to avert the danger of electric shock and electric discharges.
	PACKAGING INSTRUCTIONS
	INSTALLATION INSTRUCTIONS: Describes the installation procedure of the inverter.
	OPERATING INSTRUCTIONS: Describes the use of the inverter and its graphic display.
	DISPOSAL: Contains useful information for disposing of the inverter.

## 4. SAFETY INSTRUCTIONS AND OTHER WARNINGS

The failure to follow these instructions may have serious consequences, such as the destruction of the device, personal injury or death due to electrocution. Therefore, the following safety instructions must be read and understood before installation and use of the inverter. For any clarifications or additional information, contact the FIMER technical service.



### Upon receipt of the inverter:

- Once the inverter has been removed from its original packaging, visually inspect for damage that may have occurred during shipment. If damage is found, contact the dealer or manufacturer.



### Dangerous voltages:

- The solar inverter uses high voltages that may cause damage, even serious, to people.
- The conductors and components with dangerous voltages are segregated into special areas that can only be accessed by using tools not supplied with the inverter.
- The inverter must always be used with all the panels properly secured and with the front door closed.
- All maintenance and repairs that require access to the inside of the device can only be performed by FIMER technicians or by properly trained personnel.
- Before removing any panels of the machine (which can only be performed by FIMER personnel), it is absolutely necessary to open the switches on the direct current side (solar field) and on the alternating current side (mains) and wait at least 10 minutes to allow all the capacities inside the inverter to be completely discharged.
- Always make sure there are no dangerous voltages by measuring with a multimeter.





### Grounding:

- The inverter is a Class I device
- Due to EMC filters, the machine has a high dispersion current towards the ground (around 500mA in normal operating conditions and in the presence of undistorted and undisturbed mains power); therefore, it can only be operated with a fixed protection connected.
- Always connect the ground wire to the appropriate copper bar provided for this purpose and identified by the symbol .
- In case of disconnection of the inverter, disconnect the ground wire last.



### Plant:

- Always connect the inverter to the power grid and do not connect it to any other type of voltage or current generator other than the solar panels in order to prevent damage and breakage.
- Follow the directions and requirements given by the manufacturer of the panels that make up the photovoltaic generator, and by the electric grid company.
- Power up the inverter with the values specified in the technical specifications of the product and indicated in the device's rating values.
- Provide a circuit for the emergency shutdown of the machine (EPO circuit).



### Safety standards:

- In addition to the installation and operating operations, it is important to comply with the local security and safety regulations on accident prevention and environmental protection.
- Personnel who access the premises where the inverters are installed must always wear ear protection. These ear protections must be available in this area in an easily accessible and clearly visible position; the need for their use must be clearly highlighted by a special sign on the wall.



### **Safety and danger signs:**

All the safety and danger signs applied on the device:

- must be kept legible
- must not be damaged
- must not be removed
- must not be covered with stickers or writing



### **Introduction of objects:**

- Do not introduce objects into the ventilation holes and avoid contact with any type of liquid; only clean with a dry cloth. These precautions must also be observed when the machine is turned off.



### **Walk-on capability:**

- the upper panels of the inverters are not designed to support heavy loads. Never climb on the equipment, do not rest against it and do not use it as a support for additional devices (walkways, pipes, ventilation ducts etc...).



### **Cable section:**

- Make sure the cables entering and exiting the inverter are of the appropriate size. Also check the cables of the system.
- The connections, section of the cables used and the installation must comply with the regulations in force.



### **Initial start-up:**

- Never supply power to the apparatus before a site inspection is carried out by competent personnel expressly authorised by FIMER.



### **Subsequent start-ups:**

- Initiate the start-up procedure with all the switches open.



### Handling:

- The inverters are very heavy devices and should only be handled and moved by qualified personnel.
- Check the load-carrying capacity of the floor slabs and any “raised” floors on which the inverter will be placed.
- Do not store or carry the system on an angle and do not rest it on its side.



### Installation area:

- The device must be installed in a dedicated room.
- The heavy duty inverters, by their nature, are noisy and suitable for installing in industrial environments.  
Therefore, the installer must be responsible for positioning the equipment in an adequately insulated room and/or in a room away from places where people spend extended periods of time.
- The inverters cannot be installed in areas where unqualified personnel can freely circulate.
- The protection degree of the device is IP20: therefore, it is not suitable for outdoor use.
- The location where the inverter is installed must be equipped with appropriate extractor fans to ensure the necessary cooling of the machine and that the temperature of the room where the inverter is installed falls within the allowable temperature range (see the section relating to the technical specifications).  
If the required change of air is not observed, the temperature of the room where the inverter is installed will increase. This in turn will shorten the life of the inverter, reduce the output and, if the maximum temperature declared is exceeded, cause damage to the machine.
- Keep the distances reported in section 11.3 around the machine in order to guarantee sufficient cooling of the apparatus.
- Always check that, in addition to the air extractor fan, there is also an opening (equipped with mesh) to allow air to enter.
- Do not connect air cooling ducts directly to the machine. The fans inside the apparatus are not able to push air into the ducts (the prevalence is not sufficient). If ventilation ducts are required, contact the FIMER technical centre.
- The room must be closed on all sides and on the roof (it is absolutely forbidden to install the inverter in a simple shelter or in a room with no walls and/or with no doors that can be closed).
- The floor of the room must be made of concrete or similar materials.
- The floor must not be made of dirt or however, dusty.
- The room must be dry and not subject to flooding, even if only small.
- To ensure correct functioning of the apparatus, make sure the cooling air inlets and outlets are not blocked; if obstructed, the inverter will not be able to supply all the power available by the solar field and will have a shorter operating life.
- The apparatus is not suitable for bathrooms or other types of humid areas.

- The apparatus is not suitable for installing in common areas such as hallways, stairwells, etc.
- The inverter is not designed to be installed in environments subject to knocks or vibrations, for example, transportation by road, on tracks, on cables, air, sea and similar means (such as cranes, overhead travelling cranes, parts of machine tools subject to movement or vibration...).
- The inverter is designed to take into account a **pollution degree whose value is 2.**
- Do not install the inverter in environments where there is a dusty or explosive or corrosive or abrasive or saline atmosphere.
- Any installation not complying with these recommendations will lead to the immediate termination of the warranty and the cessation of any liability for any malfunctions and any resulting consequences.



### Positioning:

- Position the inverter away from heat sources.
- Avoid direct exposure to sunlight.
- Position the inverter on a base consisting of a stable flat surface that extends beyond the base of the product in all directions.
- Install the inverter in areas large enough to allow maintenance, opening of the doors, removal of the external and internal panels for allowing routine maintenance and repair in case of faults.
- Follow the values shown in the figures contained in this manual and the warnings reported in the “Installation” chapter.
- Any installation not complying with these recommendations will lead to the immediate termination of the warranty and the cessation of any liability for any malfunctions and any resulting consequences.



### Repairs:

- Never repair the inverter alone, but always contact the manufacturer or their authorised service centre.
- Any repair not authorised in writing and not directly managed by FIMER, besides being objectively dangerous, determines the immediate termination of the warranty and cessation of any liability for any malfunctions and resulting consequences.
- In case of repair, only use original spare parts, as there is no guarantee that any unoriginal parts will be able to withstand the stresses to which they are subjected during normal operation.
- Never make any changes and never install unauthorised devices inside the inverter.
- Never bypass the safety devices and have them reset by personnel specialised to perform the necessary repairs before restarting the apparatus.



### **Support and service:**

- Service must be requested when the apparatus has been damaged in any way such as in cases where liquid has penetrated, objects have fallen on top or inside the apparatus, when it has been exposed to rain or humidity (outside the specified values), when it does not operate properly, when there are evident changes in performance or when it has been dropped.
- Faults that may affect the safety of the machine and the entire system must be repaired before restarting the system.



### **Duration of the inverter:**

- The FIMER inverters are designed and built to guarantee a high MTBF. However, it should be noted that the MTBF is a statistical parameter with all the conceptual and practical limitations that this entails.
- Remember that the MTBF relates to a device that is properly ventilated, installed and maintained; in other words, it cannot account for conceptual or practical errors in the construction of the plant, for neglect or wilful misconduct.
- It should be pointed out that continuous operation of the machine at high temperatures will lead to the shortening of its expected life.
- The inverters discussed in this manual, due to their function, are devices only suitable for professional users and should not be used by inexperienced personnel.



### **Maintenance:**

- To ensure the effective and expected life expectancy of the apparatus, it is necessary to perform the maintenance described in this manual.
- Routine maintenance of the apparatus must be periodically performed by qualified service personnel (such as the installer of the PV), visually checking the status of the machine and its components internal to it and checking the tightening of the screws disconnectors, Bus DC and component output on the grid side, for more details refer to as set out in Appendix 3 of this manual.
- The extraordinary maintenance of equipment must always be carried out by authorized personnel by FIMER or its service center, and this is the only way to ensure original and new spare parts are always used and it is the only way to ensure that (according to maintenance contract) the inverter is constantly updated with any improvements made in the meantime (in accordance with state of the art). In particular, if unoriginal spare parts are used, which are not new or not in line with the state-of-the-art, the apparatus will be considered “modified” with the resulting legal and practical consequences.



### **Rating plate of the product:**

- The identification plate of the product reporting the code, serial number and technical data of the apparatus, can be accessed by opening the front door of the inverter (next to the sectioning organs).
- For any communications relating to the apparatus, report the serial number affixed on this identification plate.



### **Modifications to the apparatus:**

- Any modifications to the apparatus not explicitly and formally authorised by FIMER immediately leads to the termination of the warranty and the cessation of any liability for any malfunction and resulting consequences.



### **Signals available to the user:**

- All the signals given to the user via the relay contacts are completely isolated from dangerous voltages.
- The insulation between the various contacts is only suitable for voltages below 48Vac (60Vdc), these contacts must not be used to change mains voltages.



### **Packaging:**

- Any transport must be made with the inverters contained in the original packaging.
- In particular, machines returned for repair with inadequate packaging or transported in a horizontal position shall not be accepted or will not be recognised by the warranty.



### **Limitation of liability:**

- Under no circumstance shall FIMER be liable for any direct or indirect damages arising from the malfunctioning of the equipment (including damages for loss of earnings or profits), even assuming that FIMER had been informed of the possibility of these damages.
- The manufacturer assumes no liability for improper use or any use other than that for which the inverter was intended, including the failure to follow and perform the periodic maintenance operations, and which could cause damage or malfunction.
- The failure to respect the environmental operating conditions of the inverter and the installation requirements described in this manual may cause damage to the

equipment or to the system and is considered equal to the improper use of the inverter for which FIMER shall be exempt of any liability.



#### **Disposal:**

- WEEE stands for Waste of Electrical and Electronic Equipment (EEE), including all components, subassemblies, and any consumables that form an integral part of the product when a decision is made to discard it. The legislation provides for two main categories called Professional WEEE and Household WEEE.
- Professional WEEE refers to all waste of electric and electronic equipment destined for industrial use.
- The inverters described in this manual are professional products and therefore, should be considered as professional WEEE at the time of their disposal.
- At the time of writing of this instruction manual the application of the legislation was not yet final, therefore please contact the distributor and/or manufacturer for information on the disposal or, alternatively, bring the equipment to a collection point for recycling the electric and electronic equipment.



#### **Electric shock and surges:**

- The inverter is equipped with a standard Class 2 arrester on the DC input line and on the AC output line.
- This arrester protects the inverter, but particularly in case of connections to the long solar field, is not able to protect the panels.
- We strongly advise the installation of string boxes equipped with their own surge protection device, suitable for FV plant.

## 5. TECHNICAL SPECIFICATIONS OF THE INVERTER

Models	R5010TL	R10000TL
<b>DC Input - PV Module</b>		
MPPT voltage range ( $V_{DC}$ )	675 – 1.000 V	675 – 1.000 V
Absolute max DC voltage ( $V_{DC}$ )	1.100 V	1.100 V
DC-voltage ripple (%)	<3%	<3%
Maximum input current ( $A_{DC}$ )	800 A	1.600 A
DC control mode	Rapid and efficient MPPT control	Rapid and efficient MPPT control
Number of MPPT	1	1
Reverse Polarity Protection	•	•
DC input connection	Integrated DC Switch	Integrated DC Switch
Overvoltage Protection	SPD varistor device Class II (Opt. Class I+II)	SPD varistor device Class II (Opt. Class I+II)
<b>AC Output grid</b>		
Max Power (kW) (Note 1)	512* kW @ 25°C 500 kW @ 50°C	1.091* kW @ 25°C 1.025kW @ 50°C
Max Apparent Power Smax (kVA)	512* kVA @ 25°C 500 kVA @ 50°C	1.091* kVA @ 25°C 1.025 kVA @ 50°C
Maximum Current ( $A_{AC}$ ) (Note 1)	785* A @ 25°C 740 A @ 50°C	1.575* A @ 25°C 1.480 A @ 50°C
Max unbalance current	< 2%	< 2%
AC output Voltage ( $V_{AC}$ )	400V <sub>RMS</sub> ±10%	400V <sub>RMS</sub> ±10%
Nr. Phase	3-phase (L1 – L2 – L3 – PE)	3-phase (L1 – L2 – L3 – PE)
Frequency (Hz)	50/60 Hz	50/60 Hz
Aux. power supply ( $V_{AC}$ - $I_{AC}$ )	230V ±10% - 16A (L-N)	230V ±10% - 16A (L-N)
Auxiliary control supply (V)	230V ±10% - 10A (L-N)	230V ±10% - 10A (L-N)
Distortion factor (THDi) (Note 2)	<3%	<3%
Power Factor (Note 3)	From 0 to 1 inductive or capacitive	From 0 to 1 inductive or capacitive
Galvanic insulation	No (transformerless)	No (transformerless)
AC input connection	Magnetothermic circuit breaker	Magnetothermic circuit breaker
<b>General Data</b>		
Maximum efficiency	98.90%	98.90%
European efficiency	98.62%	98.62%
Static MPPT efficiency	> 99.9 %	> 99.9 %
Dynamic MPPT efficiency	> 99.8 %	> 99.8 %
Night consumption (W)	< 60 W	< 60 W
Weight (kg)	1.300 kg	1.450 kg
Protection degree	IP20 (Opt.31)	IP20 (Opt.31)
Cooling	By using fans speed controlled by temperature	By using fans speed controlled by temperature
Dimensions (W x D x H)	1.400x825x2.237 mm	1.750x825x2.237 mm
Noise level (dBA)	< 70 dBA	< 70 dBA
Operating temperature (°C) (Note 4)	-10° C +50° C	-10° C +50° C
Storage temperature (°C)	-20° C +60° C	-20° C +60° C
Humidity (Not condensing) (%)	0 ÷ 95%	0 ÷ 95%
Height above the sea (without derating) (Note 5)	1.000 m	1.000 m
Air Flow	2400 m <sup>3</sup> /h	4.850 m <sup>3</sup> /h
Overvoltage Category	II	II
Color	RAL 9006	RAL 9006

\* : Overpower @25°C is optional. If not required the maximum power @25 °C is the same of @50 °C

Note 1: Power factor ( $\cos\phi$ )= 1 and Vac nominal

Note 2: THD is lower than 3% for inverter power greater than 25%

Note 3: P-Q capability is semicircular with radius equal to  $S_{max}$  for all MPPT range

Note 4: From 45°C to 50° (or optional from 50° to 55°C) derating of power

Note 5: above 1000m derating of the Maximum Operating Temperature of 0.4 °C per 100 m up to 3000 m a.s.l.

above 2000m derating of the Absolute Maximum DC Voltage of 1.3 % per 100 m up to 3000 m a.s.l.

above 2000m derating of the Maximum MPPT Voltage of 1.2 % per 100 m up to 3000 m a.s.l.

(contact Factory for details)

Note: Each inverter must be connected separately to its own LT/MT transformer or it has to be connected to a separate LT secondary input of the LT/MT transformer. Two or more inverters cannot be connected in parallel to the same LT secondary input of the LT/MT transformer.



## 6. DECLARATION OF CONFORMITY



**Inverter for Life**

Uffici : Via J.F. Kennedy  
20871 Vimercate (MB) Italy  
Phone: +39 039 98981  
Fax: +39 039 6079334

web site: [www.fimer.com](http://www.fimer.com)  
e-mail: [info@fimer.com](mailto:info@fimer.com)

INFOLINE  
tel. +39 039 6079326

SOLAR TECHNICAL SERVICE  
[service.solar@fimer.com](mailto:service.solar@fimer.com)



DICHIARAZIONE DI CONFORMITÀ CE	DECLARAÇÃO DE CONFORMIDADE CE	ÖVERENSSTEMMELSESERKÜERING CE
CE DECLARATION OF CONFORMITY	FÖRSÄKRAN OM ÖVERENSSTEMMELSE CE	YHDENMUKAISUUSVAKUUTUS CE
KONFORMITÄTSEKRLÄRUNG CE	VERKLARING VAN CONFORMITEIT CE	UYGUNLUK BİLDİRİMİ CE
DÉCLARATION DE CONFORMITÉ CE	BEKREFTELSE OM ÖVERENSSTEMMELSE CE	إعلان مطابقة للمواصفات الأوروبية CE
DECLARACIÓN DE CONFORMIDAD CE		

Si dichiara che l'apparecchio tipo  
We hereby state that the machine type  
Wir erklären, dass das Gerät Typ  
On déclare que la machine type  
Declara que el aparato tipo  
Declara-se que a máquina tipo  
Vi försäkrar att maskinen av typ  
Verklaard wordt dat het apparaat type  
Vi bekræftelser, at maskinen type  
Vi erklærer, at maskinen type  
Todistamme etta laite mallia  
Yandaki makine modellerinin

نصرح بأن الجهاز نوع

SOLAR  
INVERTER  
MODEL

R10000TL  
R5010TL

è conforme alle direttive  
is in compliance with the directives  
den Richtlinien entspricht  
est conforme aux directives  
es conforme a las directivas  
é conforme as directivas  
ar i överensstammelse med direktiven  
overeenkomstig de richtlijnen  
er i överensstammelse med direktivene  
er i överensstammelse med direktivene  
on yhdenmukainen direktiivissa  
yandaki direktiflere ve

مطابق للتوجيهات

2014/35/EU (LVD)

2014/30/EU (EMC)

2011/65/EU (RoHS)

è conforme alle norme  
is in compliance with the rules  
den Normen entspricht  
est conforme aux normes  
es conforme a las normas  
é conforme as normas  
ar i överensstammelse med direktiven  
overeenkomstig de richtlijnen  
er i överensstammelse med direktivene  
er i överensstammelse med direktivene  
on yhdenmukainen direktiivissa  
yandaki normlara uygun olduğunu  
bildiririz

ومطابق للمقاييس

EN62109-1:2010  
EN62109-2:2011  
EN61000-3-11:2001  
EN61000-3-12:2011  
EN61000-6-2:2005  
EN61000-6-3:2007  
EN61000-6-4:2007  
CEI016 - 2014-09  
CEI016:V1 2014-12  
CEI016:V2 2016-07

VIMERCATE (MB)

10-04-2018

AMBROGIO F. CARZANIGA

CHAIRMAN

Ogni intervento o modifica non autorizzati dalla FIMER faranno decadere la validità di questa dichiarazione.  
Any tampering or change unauthorized by FIMER shall immediately invalidate this statement.  
Eingriffe und Änderungen ohne die Genehmigung von FIMER machen die vorliegende Erklärung ungültig.  
Toute opération ou modification non autorisées par FIMER feront déchoir la validité de cette déclaration.  
Qualquer intervención o modificación no autorizadas por FIMER, anularán la validez de esta declaración.  
Qualquer intervenção ou modificação que não seja autorizada pela FIMER anulará a validade desta declaração.  
Denna försäkran upphör att gälla vid eventuella ingrepp eller ändringar som ej är godkända av FIMER.  
Iedere niet door FIMER geautoriseerde ingreep of wijziging doet de geldigheid van deze verklaring vervallen.  
Denne bekræftelse bortfaller ved evt. indgæb eller ændringer, som ikke er godkendt af FIMER.  
Denne erklæring bortfalder ved evt. indgæb eller ændringer, der ikke er godkendt af FIMER.  
Jokainen valiintulo tai muutos ei valtuutettu FIMER rappliditaa k'fseisen lausunnon pitävyyden.  
FIMER'in onayı olmaksızın yapılacak her türlü kurcalama ve değişiklik yukarıdaki bildirim geçersiz kılar.

أي عمل أو تعديل غير مرخص من قبل شركة FIMER يبطل فوراً مفعول هذه الوثيقة.

## 7. INVERTER BLOCK DIAGRAM

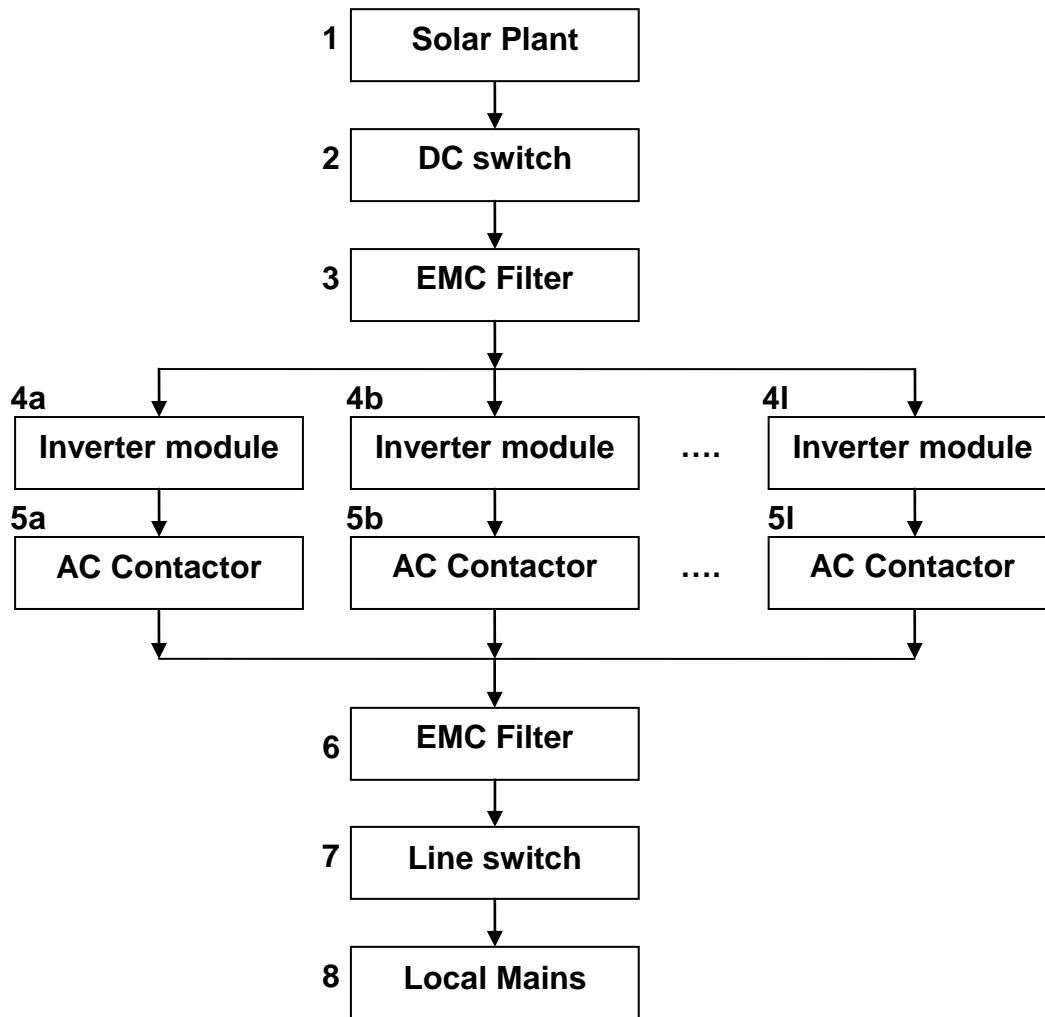
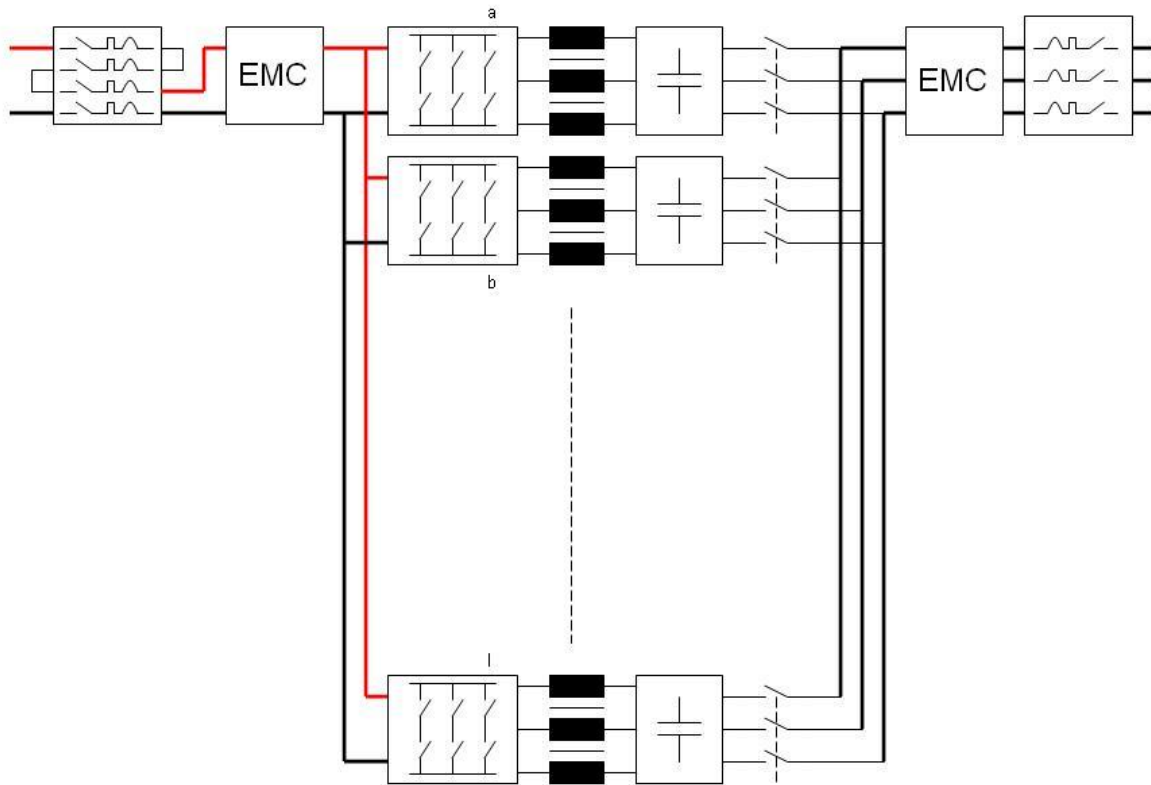

**Fig. 1**

1	solar field	5a, b ...l	module contactors
2	input switch	6	low-pass power filter
3	filter for electromagnetic compatibility	7	line switch
4a, b ...l	10 inverter modules	8	Low voltage local mains (LV winding of the LV-MV transformer)

N.B.: The block diagram is related to the R10000TL inverter;  
 the R5010TL inverter only requires 5 inverter IGBT stack modules; and relative contactors;  
 the R10000TL inverter requires 10 inverter IGBT stack modules; and relative contactors;

## ELECTRIC BLOCK DIAGRAM



N.B.: The block diagram of the upper figure is related to the R10000TL inverter;  
the R5010TL inverter only requires 5 inverter IGBT stack modules; and relative contactors, inductors and capacitors;  
the R10000TL inverter requires 10 inverter IGBT stack modules; and relative contactors, inductors and capacitors;

## **8. DESCRIPTION OF OPERATING PRINCIPLE**

### **8.1 Introduction**

The R15010TL and R10000TL inverters, as all the other ones of the transformerless central family, are suitable for connecting photovoltaic systems to public medium-voltage grids for the production of electricity. They are not equipped with isolation transformers between the solar field and grid because this function is performed by a special LV-MV transformer housed in an appropriate facility.

These inverters have a sophisticated maximum power point tracking system (MPPT: Maximum Power Point Tracking) that allows constantly optimising the operating point in relation to the irradiation conditions, to the characteristics of the solar panels and to their temperature.

The modular design of the inverter allows obtaining a particularly high production yield (output), even in conditions of low irradiance (diffused lighting, at sunrise and sunset), high reliability (MTBF), very short repair times (MTTR) and a need for very few spare parts.

The adoption of an innovative modulation system (IPCCM - Improved Predictive Current Control Modulation) not only guarantees a perfectly sinusoidal current waveform, but above all allows obtaining very high conversion efficiency.

The inverter is controlled by a multi-microprocessor in which a supervisor processor tracks the optimum point and operating coordinates of the various modules in order to maximise, in every operating condition, the efficiency of the system.

Other processors rely on the operation of each module by following the instructions coming from the supervisor (slave modules).

Another two microprocessors are responsible for displaying the state of the machine on a colour touch-screen display located on the front of the apparatus, and for managing the commands and remote diagnostics.

As for the components used, in order to maximise reliability and duration of the life of the apparatus, the electrolytic capacitors were completely removed from the control circuits and, above all, from the power circuits.

In particular, the electrolytic capacitors positioned in parallel to the solar field have been replaced by components in metallised polypropylene.

The fans were also selected from components with variable speed to maximum the expected life.

In order to ensure minimum repair times, all the components of the inverter, including the magnetic components, can be replaced from the front; this means there is no need to access the machine from the rear.

## **8.2 Start-up**

At night, the inverter periodically checks to see if voltage is present on the solar field (stand-by mode). During stand-by mode, the consumption of the inverter is limited to about 60W.

When the supervisor detects that the voltage on the solar field is such to permit a start-up attempt (greater than 850V) the supervisor starts an initial inverter module without attempting to connect to the grid.

If the voltage on the solar field is maintained at an acceptable value, the supervisor proceeds in the start-up sequence until the grid contactor of the module is closed and the production can be started.

Vice versa, if the voltage on the solar field drops (i.e. it is not even able to supply the power to operate the inverter), the supervisor stops the start-up procedure and waits for a reasonable period before repeating the attempt.

The start-up module of the inverter is not always the same, but all the modules are initiated cyclically in order to avoid long periods of inactivity in case of days with low radiation; this eliminates the formation of condensation on all inactive modules.

## **8.3 Production**

The inverter starts its production once it has been connected to the grid.

During production, the supervisor adjusts the voltage and current on the solar field in order to obtain the best production output (MPPT).

The efficiency of the system is further improved by managing the start-up of the modules in a sequential manner.

The power ranges for obtaining the maximum yield with the operation of one or more modules are memorised in a special database present inside the supervisor.

Therefore, with increasing power output, the supervisor will only run one module until it reaches a value where the output would be higher with two modules running.

On reaching the point where it would be better to have two modules running, a second module is initiated, thus obtaining the best performance possible.

The situation remains unchanged until the supervisor detects that the power output is such to allow a change in configuration.

This change will involve returning to the operation with only one module in case of a reduction in power, or in the initiation of a third module in case of an increase in power.

The cycle is repeated until enough modules are activated to obtain the maximum yield point which, in case of a solar field with full radiation, coincides with the activation of all the available modules.

As the radiation decreases, the modules are gradually turned off and disconnected.

At night, with only one module running, when the voltage on the solar field falls below the minimum operating voltage, the inverter is disconnected from the grid and goes into stand-by mode.

In order to maximise efficiency, the fans of the apparatus do not run at a constant speed, but at a variable speed depending on the current that circulates in the circuits and the ambient temperature.

This will also optimise the life of the fans that basically are the only moving parts of the inverter.

## 9. STORAGE

If the inverter is not installed immediately, it must be stored in its original packaging and protected against humidity and weather conditions.

The storage room must meet the following requirements:

Ambient temperature:  $-25^{\circ}\text{C} \div +60^{\circ}\text{C}$

Relative humidity: 95% max

The recommended storage temperature is between  $+5^{\circ}\text{C}$  and  $+40^{\circ}\text{C}$

## 10. INSTALLATION AREA

Before proceeding with installation, carefully read the section "SAFETY INSTRUCTIONS AND OTHER INFORMATION." In particular, the points relating to "Installation Area", "Positioning", and "Ventilation".

Check that the ambient temperature with the inverter running conforms to:

- Operating Temperature:  $-10^{\circ}\text{C} \div 50^{\circ}\text{C}$
- Maximum temperature for 8 hours per day:  $45^{\circ}\text{C}$
- Average temperature for 24 hours:  $35^{\circ}\text{C}$

Please note: the average temperature recommended for the life of the inverter is between  $10^{\circ}\text{C}$  and  $35^{\circ}\text{C}$ .

## 11. PRELIMINARY OPERATIONS

### 11.1 *Packaging Inspection*

On receiving the inverter, check that the packaging has not been damaged during transport.

Check that none of the anti-tip devices positioned on the packaging have turned red, otherwise, follow the instructions reported on the packaging.

Take care when removing the packaging to avoid scratching the cabinet of the inverter.

The equipment must be handled with care, any bumps and falls can damage it.

Check that the apparatus is intact without any dents; also check that all the ventilation slots are not deformed, so as to guarantee the declared degree of protection.

If the equipment is damaged DO NOT CONNECT IT and contact the supplier immediately.

## 11.2 Handling

The inverter is normally supplied on a special platform. For handling and moving, use a pallet or forklift.

When using a forklift, widen the forks until they line up with the appropriate lifting points located on the bottom of the machine.

Alternatively, **paying the utmost attention**, a pallet can be used by inserting the forks in the centre of the machine or at the proper side as shown in below attached picture.

Caution: this means the cabinet is lifted from the centre which can make it unstable, therefore only move it for short distances, on a smooth floor with the aid of a person on each side to keep the machine stable.

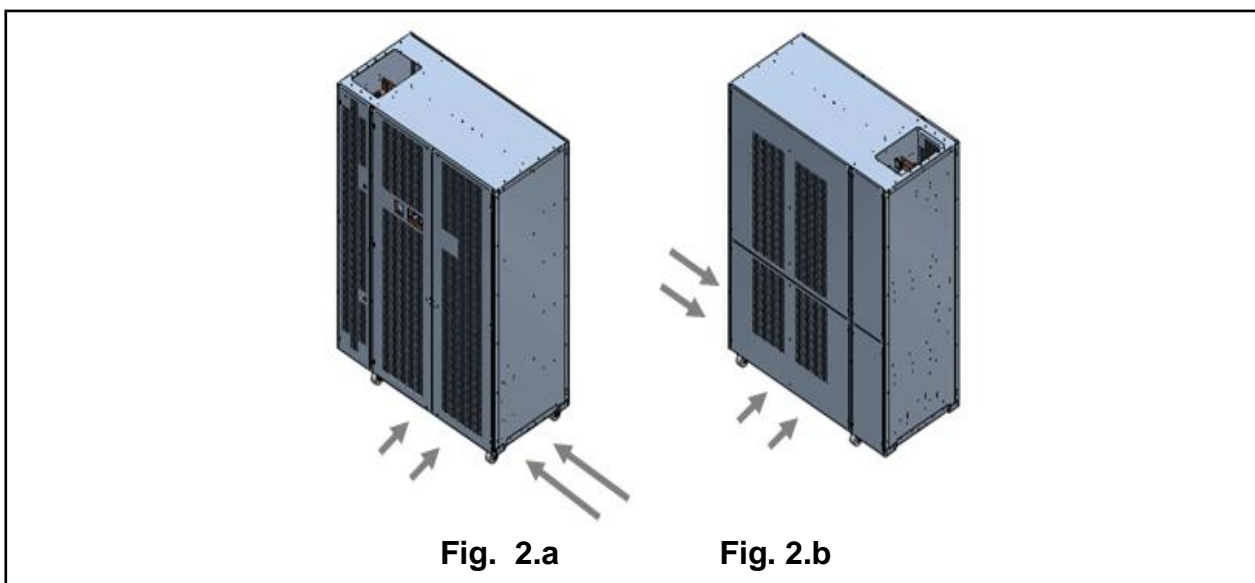

Picture related to inverter model: R10000TL

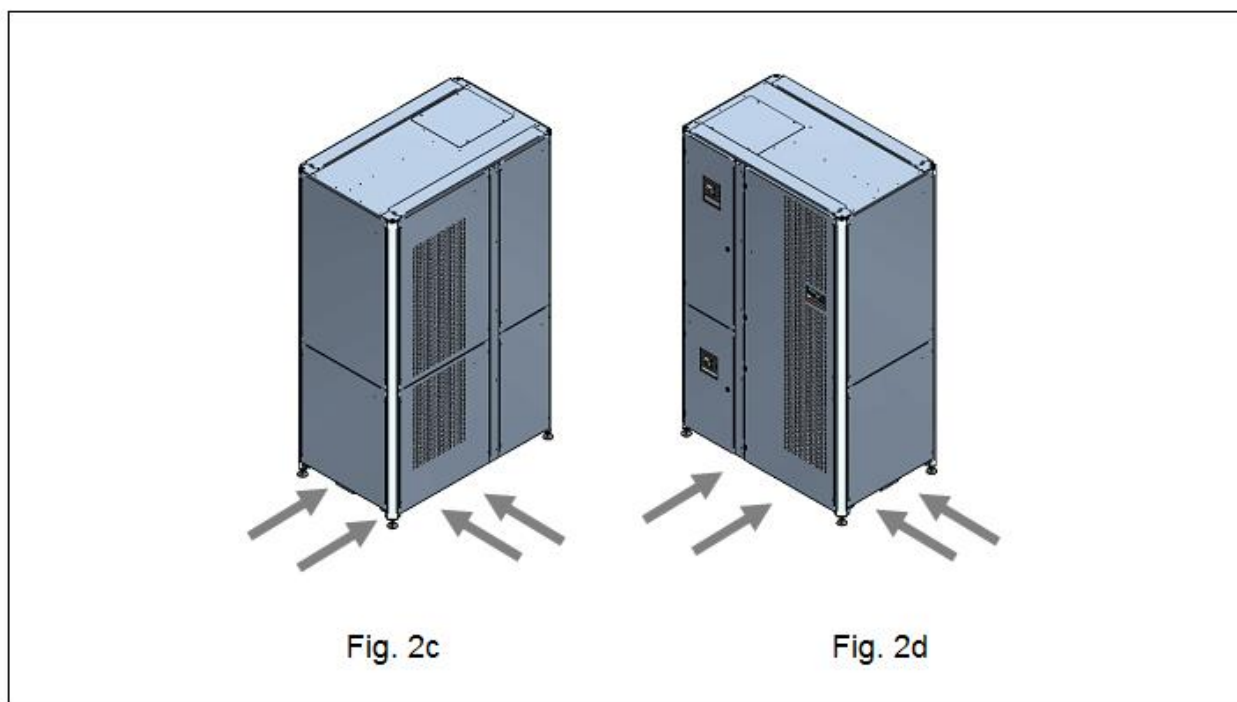

Picture related to inverter model: R5010TL

### 11.3 Positioning

The cooling air enters the inverter from the top and through the grills located on the front of the door, and exits from the back of the machine.

Follow these recommendations when positioning the apparatus:

- There must be at least one meter of free space in front of the equipment to allow for any maintenance.
- Make sure there is a distance of at least 50cm between the roof of the machine and the ceiling and 30cm between the back and the wall in order to allow a correct flow of air coming from the fans (see Figure 3).
- DC cables enter the machine from the bottom of the cabinet. The power and signal cables must be connected from the front.
- AC cables enter the machine from the top of the cabinet. The power and signal cables must be connected from the top.
- Multiple cabinets can be joined together side by side.

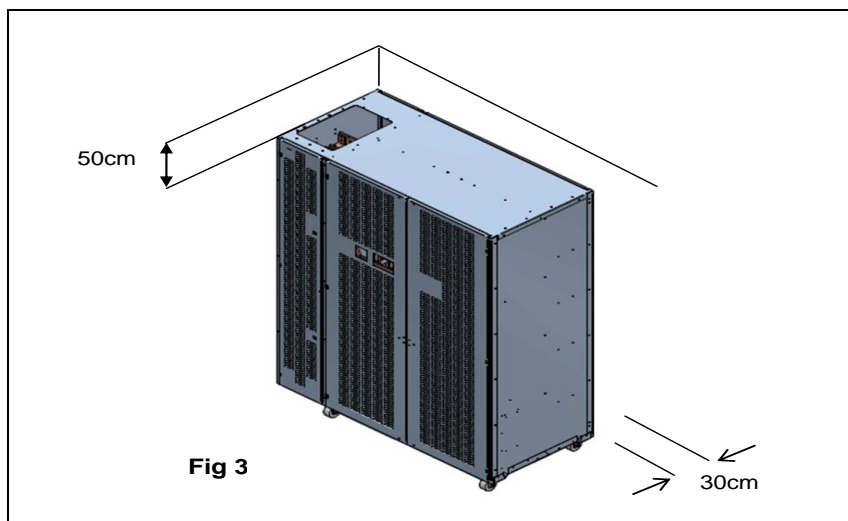

Picture related to inverter model: R10000TL

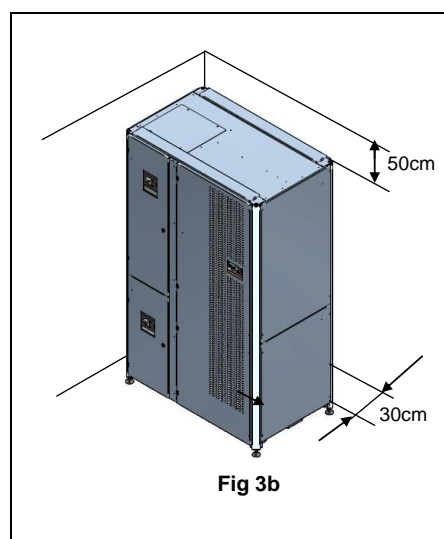

Picture related to inverter model: R5010TL



## 12 PREPARATION OF THE ELECTRICAL SYSTEM

### 12.1 System protections

The cables of the system must be properly sized to carry the maximum currents reported in the technical specifications.

In particular, the connection to the AC system is of a 3-pole type (no neutral).

A single-phase 230Vac (10A max) connection is also required for supplying power to the control logics board and display of the converter (we suggest to use a preferential supply line by UPS); a single-phase 230Vac (16A max) connection is also required for supplying power cooling fans.

#### AC output

The AC output line of the inverter has an automatic circuit breaker (whose current size is equal to 1600A for R10000TL and 1250A for R5010TL) with a breaking capacity equal to 50kA.

This breaker cannot protect the line connected to the inverter from any faults. Therefore, an appropriate protection must be installed upstream, which must be sized according to the currents in play and to the characteristics of the cable installed.

*Contribution to the short circuit current of the system: This theoretically equals the maximum current indicated in the rating data. In the short interim before shutdown (max. 200msec), the inverter provides a contribution to the short circuit current equal to the inverter's maximum rated current (see the technical specifications). This value is absolutely negligible compared to the system's normal short circuit currents.*

#### DC input

The DC input line of the has disconnecting switch whose current size is 1600A for R10000TL and 1250A for R5010TL.

### 12.2 Connections of the photovoltaic array and the electricity grid

The operations described in this chapter can only be performed by qualified personnel.

The first connection to be made is the one of the ground conductor to the bar indicated by the symbol:



The size of section of cables for wiring the GND must be equal to half of size section of a single phase of the inverter.

Connect only one cable terminal to each single point of connection of the GND copper bar.

For the connection use the M8 cable terminal by using that has to be fixed with a screw and nut using split spring washer to ensure a seal and secure the appropriate hole provided on the earth bar.



#### **DO NOT OPERATE THE INVERTER WITHOUT THE GROUND CONNECTION!**

Before making the connection, open all the switches of the machine and check that the inverter and the lines to be connected are completely disconnected from the power sources: photovoltaic array and AC mains network.

In particular, ensure that:

- the line coming from the photovoltaic array is disconnected;
- the switches of the converter of the IDC and IAC inverters are in the open position;
- there are no dangerous voltages (DC and AC) by measuring with a multimeter.

The AC network to which the inverter is connected must be a three-phase network (no neutral).

The connection system is an IT-type system. The solar inverter contains a device for monitoring the insulation resistance of the poles of the PV generator with respect to ground. If there is a loss of insulation on the photovoltaic side, the inverter generates an alarm.

The cables must be connected as shown in the figure below where are explained all the details of the wiring connection (Note: following pictures are referred to an inverter with 6 IGBT stack module; anyway the left connecting column related to the wiring of the DC and AC cable in input to the inverter are the same for all the models):

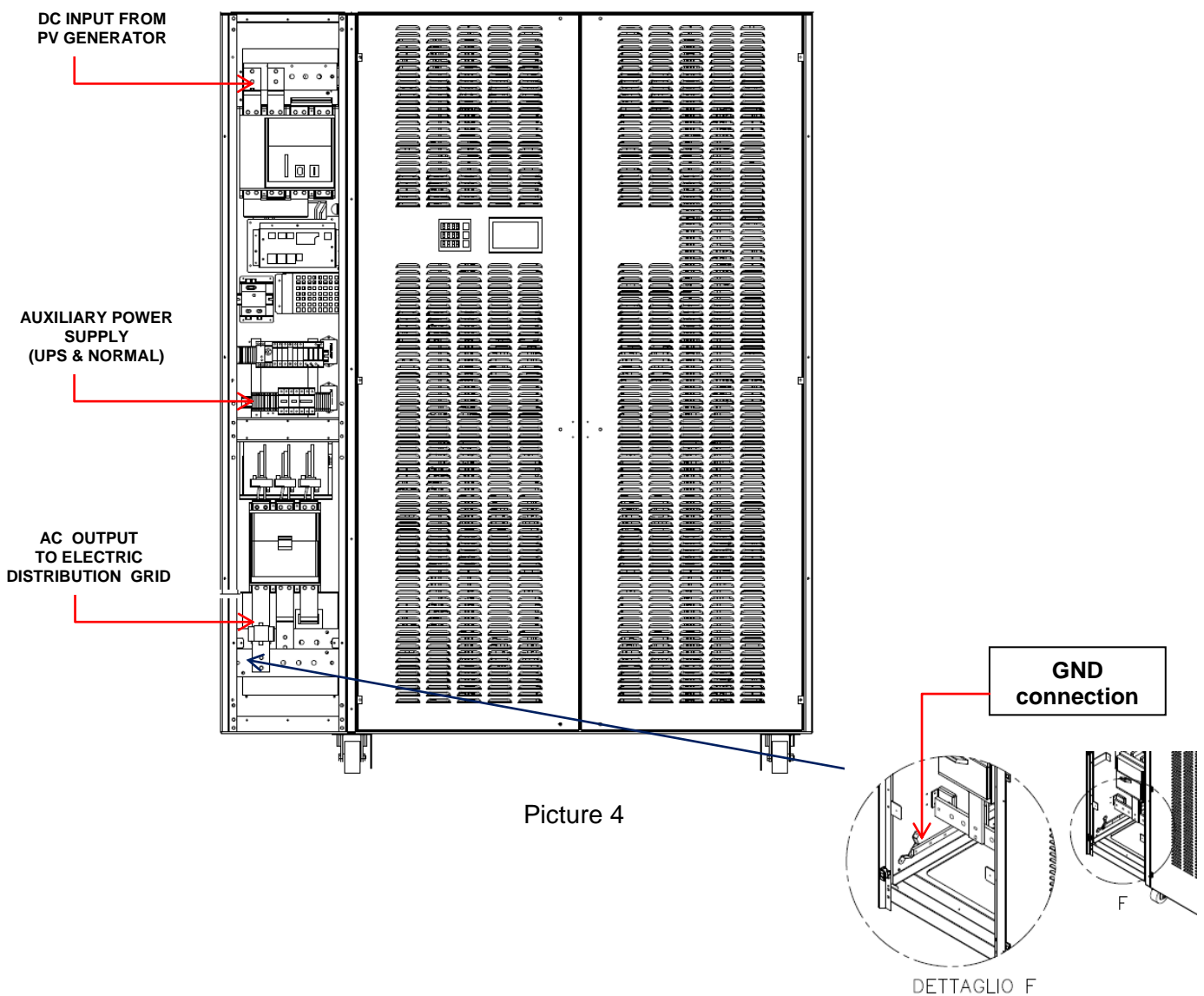

Picture 4

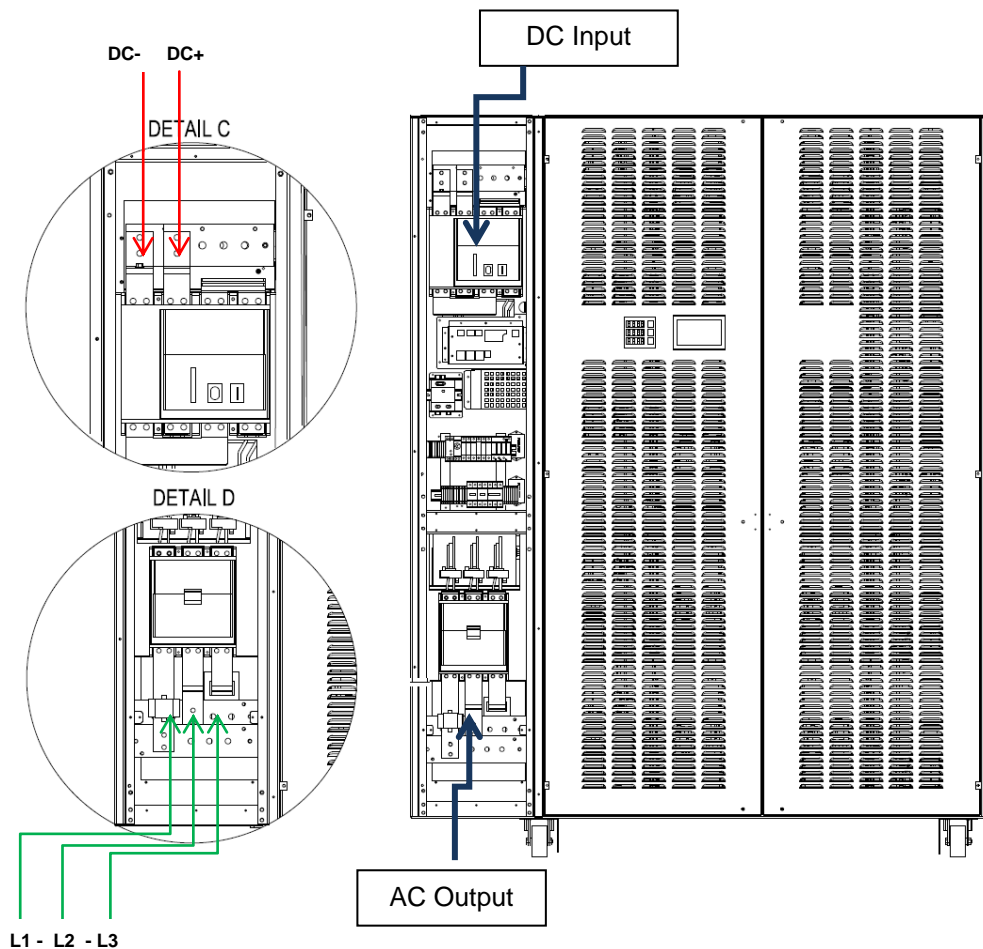

Picture 5

### PV GENERATOR SIDE

Connect the cables coming from the solar field to the  $I_{DC}$  switch as shown in Picture 4 and 5. ALWAYS CHECK FOR PROPER POLARITY OF THE SOLAR FIELD (the inverter is protected against reverse polarity of the photovoltaic array, but cannot run with the polarities inverted).

### AC MAINS NETWORK SIDE

The AC network to which the inverter is connected must be a three-phase network (no neutral).

### CONNECTION OF GRID AND PV CABLES

The photovoltaic cables or grid cables must comply with the indications reported in the Picture 4 and 5.

Pay attention when connecting the phases of the grid cables and make sure to follow the correct cyclic direction.

The inverter is protected against reverse phase sequence and cannot function if connected incorrectly. This will result in the "Phase Sequence" alarm being generated and the machine will not be able to start.



## PHOTOVOLTAIC SIDE SWITCH

The inverter contains an ABB switch:

T7D/PV-E 1600 4p 1500VDC disconnecting switch for R1000TL and T7D/PV-E 1250 4p 1500VDC for R5010TL.

Molded case switch-disconnectors up to 1500V DC in compliance with IEC 60947-3

### Electrical characteristics

Tmax PV switch-disconnectors in compliance with the IEC60947-3	T4D/PV-E	T5D/PV-E	T7D/PV-E <sup>1)</sup>
Rated service current in category DC22 A, Ie	(A) 250	500	1250-1600
Number of poles	(No.) 4	4	4
Rated service voltage, Ue	1500V DC	1500V DC	1500V DC
Rated impulse withstand voltage, Uimp	(kV) 8	8	8
Rated insulation voltage, Ui	(V) 1500V DC	1500V DC	1500V DC
Test voltage at industrial frequency for 1 minute	(V) 3500	3500	3500
Rated short-circuit making capacity, switch-disconnector only, Icm	(kA) 3	6	19.2
Rated short-time withstand current for 1s, Icw	(kA) 3	6	19.2
Versions	F	F	F
Standard terminals	F	F	F
Mechanical life	(No. Operations) 7500	7500	20000
Electrical life (operations @ 1500V DC)	(No. Operations) 1000*	1000*	500*
Basic dimensions	W (mm/in)	140/5.52	280/11.02
	D (mm/in)	103.5/4.07	178/7.01
	H (mm/in)	205/8.07	268/10.55
Weight (with standard terminals only)	(kg/lbs) 3.05/6.72	3,15/9.15	14/30.86

1) installation in vertical position only

\* openings with SOR or UVR

## OVERALL DIMENSIONS AND CONNECTIONS WITH GRID AND PV SWITCHES

According to IEC 60947-3

### T7D/PV-E

Configurations without jumpers (cables)

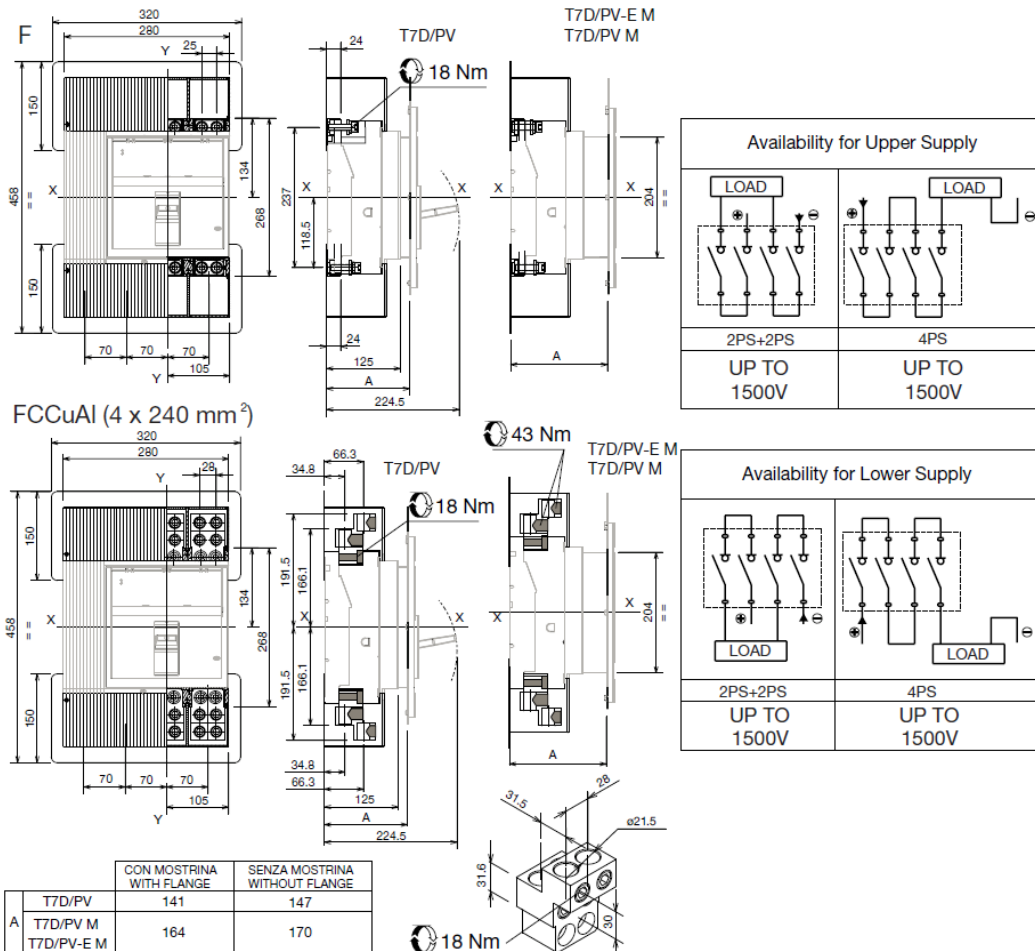

### INSTRUCTION FOR CONNECTING AUXILIARY SUPPLY (UPS and NORMAL)

The connection of the auxiliary power supply for power the control board and the fans of the inverter are realized by connecting cables to these terminals :

- **XA19 e XA20:** Normal line for power cooling fans of the inverter (the switch Q3 in Figure 6 is the one related to fans)
- **XA17 e XA18:** Preferred Supply by UPS for power the electronic board and the control circuit of the inverter (the switch Q4 in Figure 6 is the one related to this function)

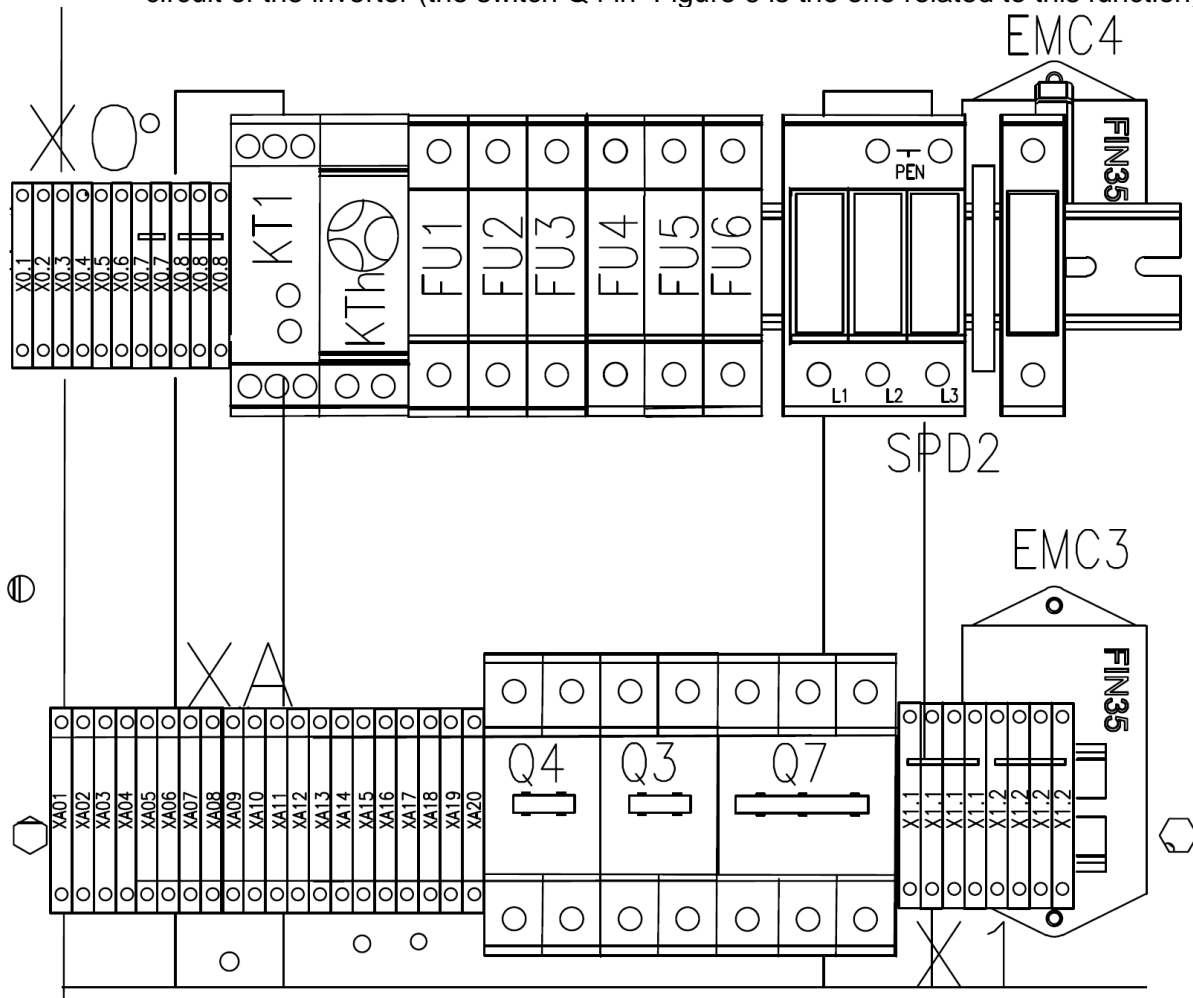

#### LEGENDA OF TERMINALS:

- XA19 – XA20 : Normal Power Supply Line
- XA17 – XA18 : Preferred Power Supply Line (by UPS)
- XA15 – XA16 : INSULATION FAULT DIGITAL INPUT ( STOP INVERTER)
- XA13 – XA14 : Inverter switched on
- XA11 – XA12 : DC SWITCH STATE CONTACT
- XA09 – XA10 : AC RELEASE COIL (DISCONNECT THE INVERTER FROM THE AC SOURCE if the command is CLOSED)
- XA07 – XA08 : RESERVED for PPC (START / STOP INVERTER if the command is CLOSED / OPEN)
- XA05 – XA06 : RESERVED for PPC (Digital Input for enable/disable the max. value of power feed into the grid)
- XA03 – XA04 : RESERVED for PPC (Analog Input correspondent to the max. value of power feed into the grid)
- XA01 – XA02 : DC RELEASE COIL (DISCONNECT THE INVERTER FROM THE DC SOURCE if the command is CLOSED)
- X0.1 / X0.2 / X0.3 / : A+ / B- / COM SIGNALS OF RS485 INPUT COMMUNICATION PORT (MODBUS RTU PROTOCOL)
- X0.4 / X0.5 / X0.6 / : A+ / B- / COM SIGNALS OF RS485 OUTPUT COMMUNICATION PORT (MODBUS RTU PROTOCOL)

Figure 6

### 12.3 Connections for signals, remote contacts and EPO (Emergency Power Off) circuit

To access the interface board, open the front door and identify the connectors shown in Figure 7.

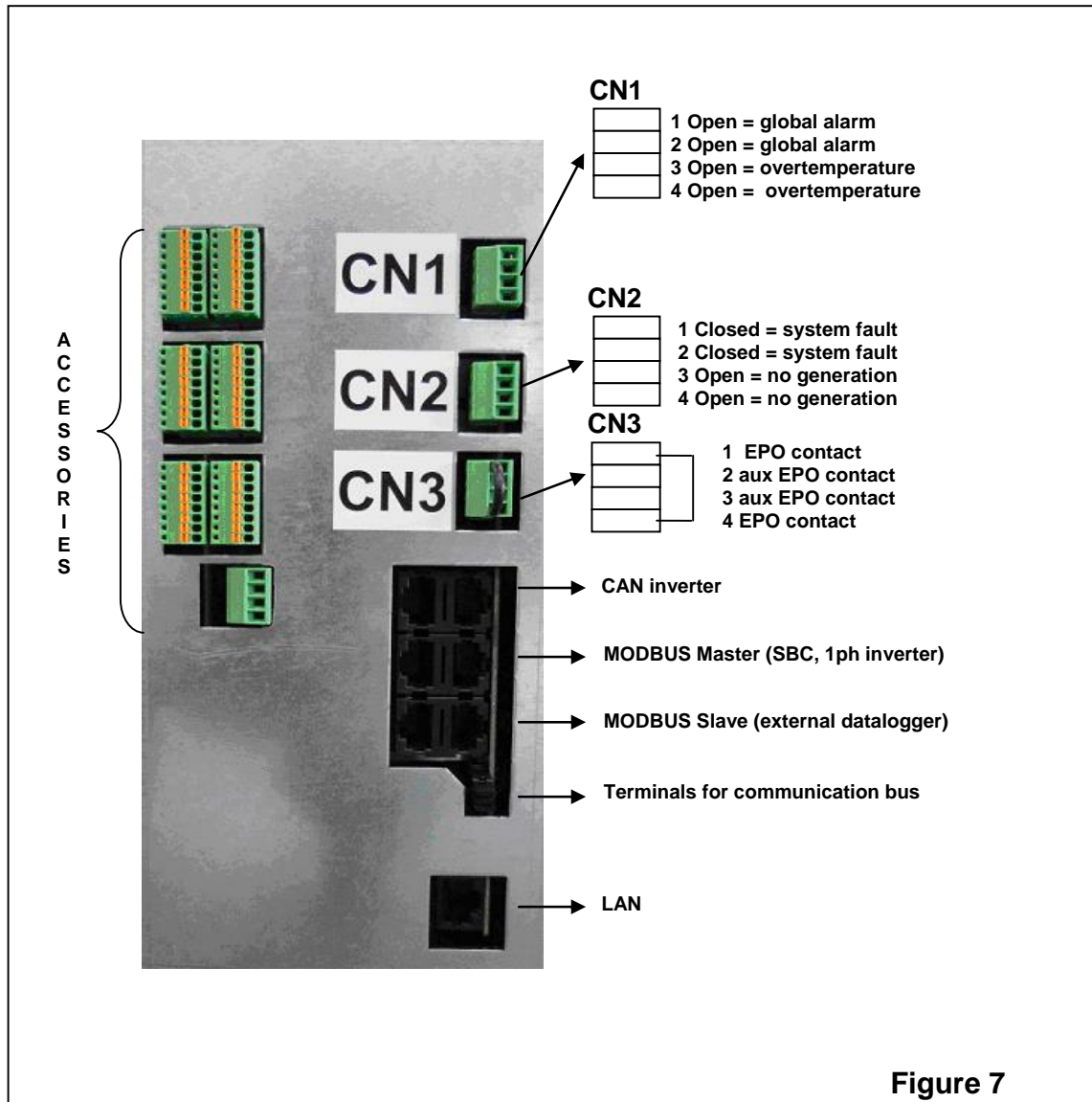

#### CN1 Connector

- The opening of the contact positioned between terminals 1 and 2 of CN1 signals a fault in the operation of the inverter. This contact also opens in case of complete power failure of the inverter.
- The closing of the contact between terminals 3 and 4 of CN1 signals an excessive rise in the ambient temperature

#### CN2 Connector

- The closing of the contact positioned between terminals 1 and 2 of CN2 signals a fault in the inverter.
- The opening of the contact positioned between terminals 3 and 4 of CN2 signals a situation of no production. This contact also opens in case of complete power failure of the inverter.

Caution: all the contacts have a maximum output of 0.5A and 24V

To make the connection to the terminals, extract the female connectors and join the ends to the signal cables. On completion of the operation, reposition the connectors.

Repeat the operation for the other signal cables.

### CN3 Connector (Connector for EPO circuit)

The opening of the jumper present on the connector positioned between terminals 1 and 4 of connector CN3 turns off the inverter.

The inverter is supplied by the manufacturer with the EPO (Emergency Power Off) terminals short circuited.

In the presence of a dangerous situation, this input can be used to turn off the inverter by simply pressing one button (normally closed).

The EPO command turns off and disconnects the inverter modules from the network, but does not open the connection to the photovoltaic array.

Therefore, dangerous voltages remain inside the machine due to the presence of the photovoltaic array voltage and the mains voltage on the contacts of the remote disconnection switches of the modules (contactors 7a, 7b..... 7l in the block diagram).

To restore the functioning of the machine, use the touch-screen display as described in section 13.

The system can be equipped with a second EPO button, or two buttons can be connected in series, or the following circuit can be created:

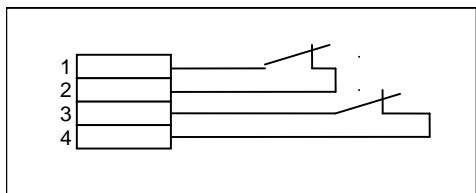

The emergency button is not supplied with the machine: the installer is responsible for ensuring that a suitable device is used (a self-hold device is recommended) which can also be used to release the switch of the solar field and line.

### CAN ports and MODBus

The CAN ports and MODBus are double socket and connected in parallel (pin to pin) between them to facilitate the creation of the bus. The termination jumper must be disconnected on all drives that are inside the bus data line, except that the first and / or last line of the data to which it belongs. Obviously, in the case of single inverter should be left closed its jumper. By connecting multiple inverters on a single bus MODBus rights LAN cables can be used to create bridges between them.

The pin ports MODBus is as follows (where in the following figure are shown the layout of a standard RJ45 connector male):

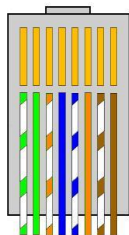

The signals of the communication bus are as described below:

#### Inverter Side

- Pin 4 A+ (BLUE)
- Pin 5 B- (WHITE-BLUE)
- Pin 7 COM (BROWN-WHITE)



### Expansion card of the interface card

The expansion card interface card is also present in the machine and the complete details of the possible connection of the radiation sensor (Sensor Box FIMER) is as described below:



TABELLA DI CONNESSIONE

CARD	SENSOR	FUNCTION
CN 17 PIN 4	BLACK	GND
CN 17 PIN 3	RED	5V
CN 16 PIN 1	ORANGE	IRRADIATION
CN 16 PIN 3	BROWN	TEMPERATURE

### 13. INITIAL START-UP

Once the above electrical connections have been made and the switch cover panel has been repositioned, the inverter can be started.

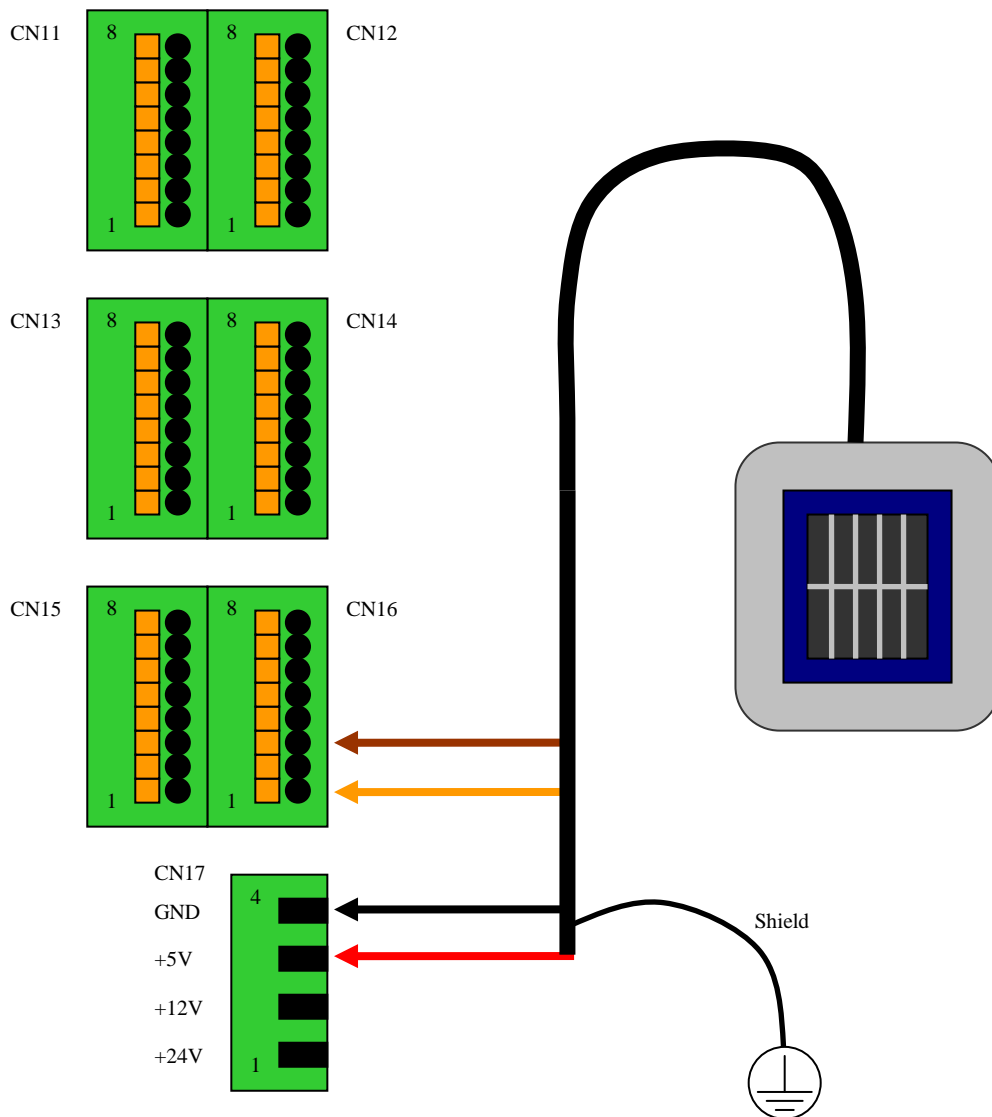
Follow these steps:

1. Open the door of the inverter to access the input and output switches;
2. Close any switches of the system;
3. Check that the DC voltage coming from the photovoltaic array falls within the range allowed by the inverter;
4. Close the IDC switch of Figure 4;
5. Close the IAC switch of Figure 4;
6. Wait for the following screen to appear on the front display of the apparatus (if the screen does not appear, stop the start-up procedure and request assistance);



### INVERTER FOR LIFE

7. At this point, the apparatus can be started;
8. Touch any point of the touch screen and the following screen appears:

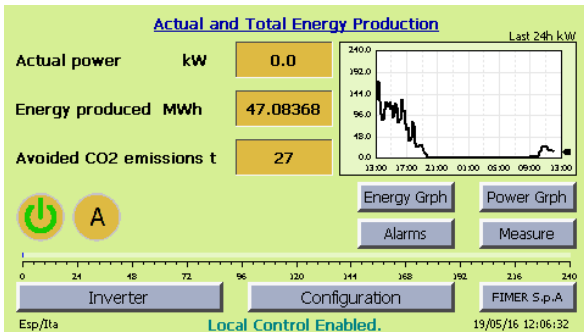

9. Touch the ON button 
10. Confirm the request
11. At this point, the inverter starts its production and the following screen appears:

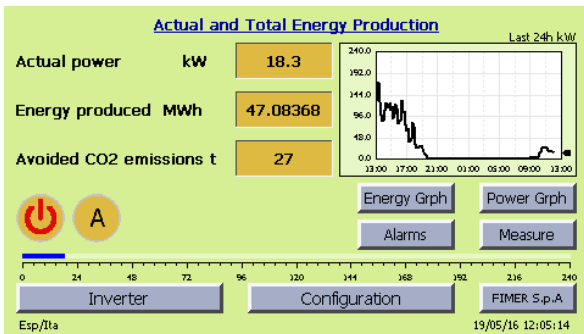

## 14. AUTOMATIC START

As described above, as soon as there is enough radiation, the inverter automatically starts without the need for any intervention.

Please note: the automatic start-up of the inverter does not turn on the display (the operation of the machine is deduced from the noise emitted during operation).

Simply touch the screen to turn on the display.

## 15. OPERATION

During operation, the user does not have to perform any operations.

The touch-screen display shows all the information relating to the operation of the machine.

### 15.1 Home page

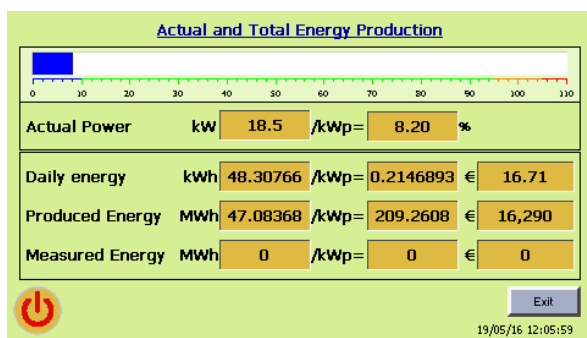
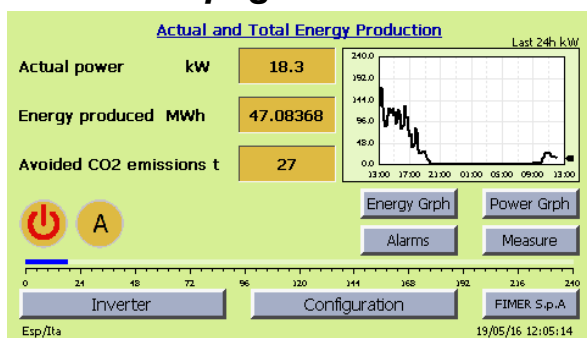

Description of the meaning of the elements displayed:

<b>Actual power</b>	Instantaneous active power delivered to the network (expressed in kW)
<b>Energy produced</b>	Total energy produced with activation of the inverter (expressed in MW/h) Pressing this area of the display opens a screen with more complete data, see below.
<b>Avoided emissions</b>	Tons of carbon dioxide equivalent to the energy produced
<b>Last 24 hours kW</b>	Trend of the instantaneous power in the last 24 hours
<b>ON/OFF button</b>	Switches the machine on and off
<b>A</b>	Automatic operating mode (Note 1)
<b>Energy Grph</b>	Displays pages about Energy production
<b>Power Grph</b>	Displays pages about Power curves
<b>Alarms</b>	Displays the state of the machine (see following sections)
<b>Measure</b>	Displays details of the machine measurements (see following sections)
<b>Inverter</b>	Allows passing to the inverter's management and verification mode (see following sections)
<b>Configuration</b>	Allows passing to the inverter's configuration mode (see following sections)
<b>FIMER S.p.A.</b>	Displays the address and telephone number of the FIMER service centre (see following sections)
<b>Esp/Ita</b>	Cyclically switches between Italian, English and Spanish language.

Note 1: the inverter must always be in automatic operating mode (the manual operating mode is only for service technicians).

## 15.2 Fault signals

If a fault occurs during operation, an acoustic signal is activated and the alarm icon appears on the current screen:



Click on the alarm icon to access the alarm summary page.  
(See section 15.4)

## 15.3 Measurements

Press the "Measure" button to open the screen summarising all the machine measurements.

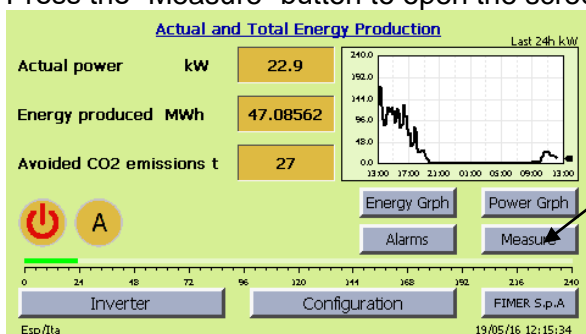

The following screen appears which contains the main electrical quantities of the apparatus.

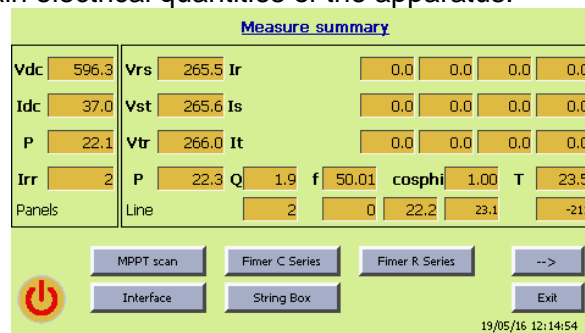
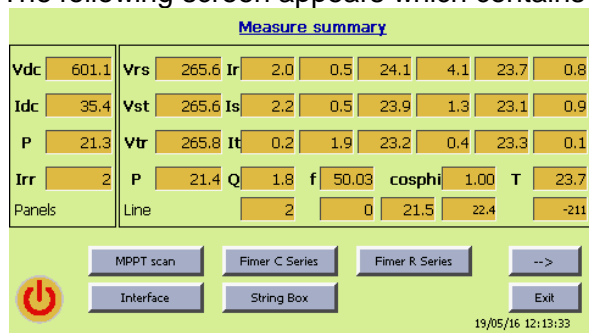

The right arrow allows alternating between the display showing the first 6 modules and the display showing the last 4 modules.

In particular:

Panels	
<b>Vdc</b>	Overall voltage of the internal DC bus
<b>Idc</b>	Total current of the solar field
<b>P</b>	Power extracted from the solar field
<b>Irr or Vpv</b>	Radiation (optional) or PV field voltage.
Grid	
<b>Vrs, Vst, Vtr</b>	Grid connected voltages
<b>Ir, Is, It</b>	Grid current fed by each module
<b>P</b>	Total active power.
<b>Q</b>	Reactive power fed into the grid
<b>f</b>	Grid frequency
<b>cosphi</b>	Cosphi measure
<b>T</b>	Temperature inside the inverter

The ON and OFF button is present on every screen (confirmation is requested to turn off the apparatus).

The “MPPT Scan” button allows, if the periodic MPPT scanning is enabled, to force the scan at this point in time.

*The MPPT scan function allows avoiding energy losses due to partial shading of the photovoltaic array.*

The “interface” button allows accessing the following screen:

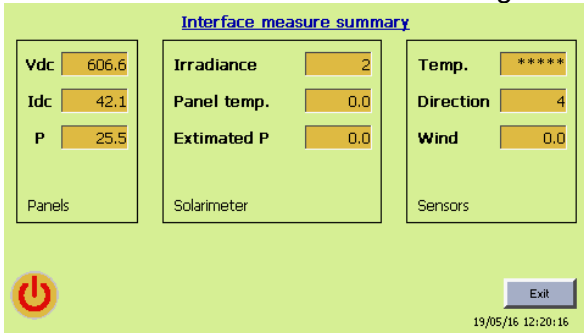

The “String Box” button allows accessing the following screen:

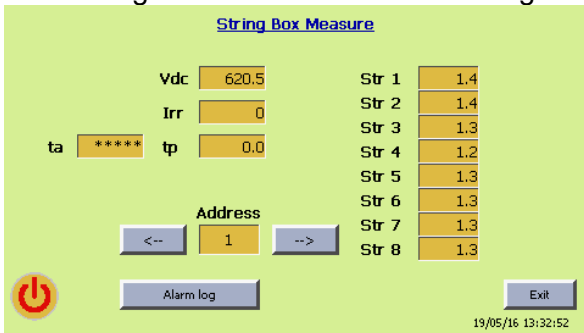

By using the arrows, all the current sensors installed in the string boxes can be selected. The values Str1....8 are the measurements of the actual current.

The “FIMER series R” and “FIMER series C” buttons allow accessing the following screens:

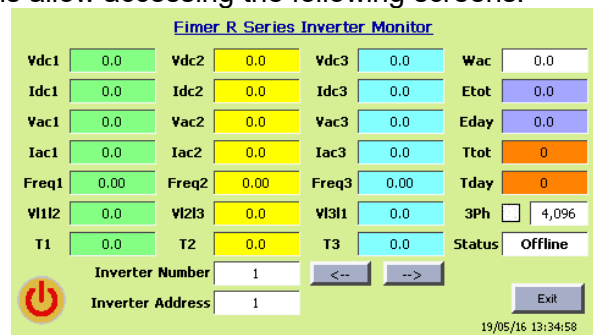
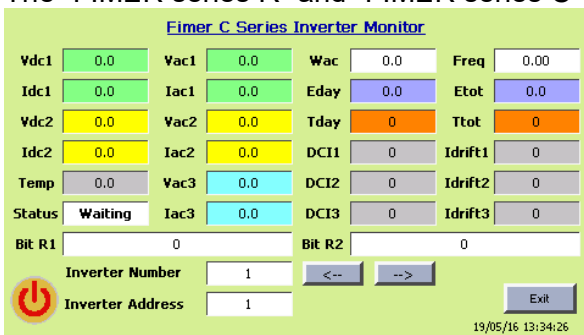

By using the arrows, all the inverters connected can be selected in order to view the actual measurements (which are sent to the “FIMERGuard” monitoring system).

Touch the "Exit" button to return to the home page.

## 15.4 Alarms

Touch the “Alarms” button (indicated by the arrow) to access the screen summarising all the signals and/or active alarms.

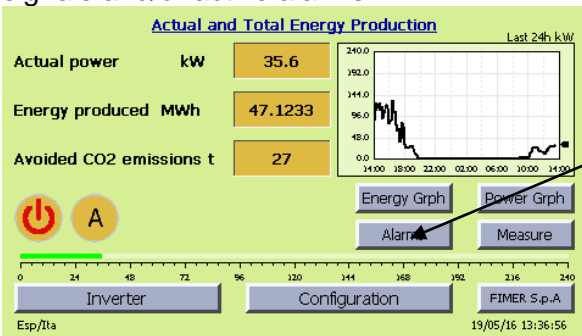

This screen can be accessed from any page by pressing the alarm icon



In both cases, the page reporting the active alarms appears:

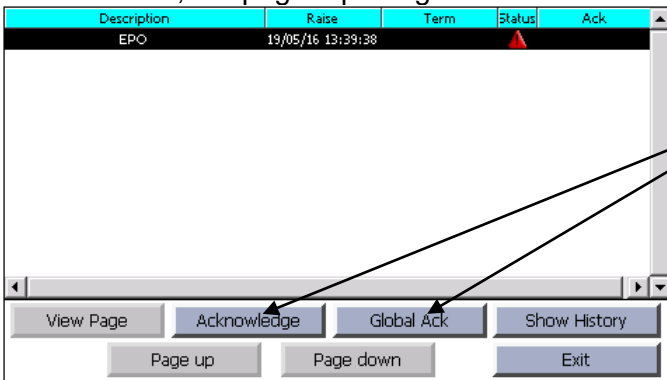

In this case, we have an active alarm that has not been silenced.

Press one of the recognition functions (indicated by the arrows) to move to the following page:

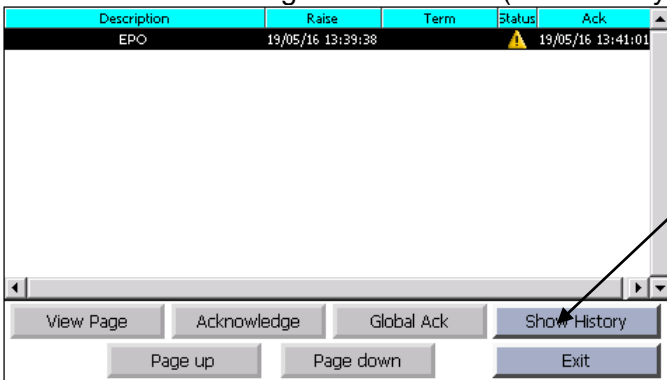

where the alarm icon has gone from red to yellow to indicate that the alarm has been silenced, but is still active.

Vice versa, if the condition that generated the alarm has disappeared in the meantime, the request for recognition will remove the alarm from the list.

To see all past and present alarms, press the “show history” button (indicated by the arrow), which will display the following screen:

Description	Raise	Term	Ack
EPO		19/05/16 13:42:07	
EPO			19/05/16 13:41:01
EPO	19/05/16 13:39:38		

Page Up Page down Save History Clean History Exit

Press the “Save Alarm History” button from this page to save the list displayed on a USB memory stick (operation reserved only to service technicians).

## 15.5 Inverter

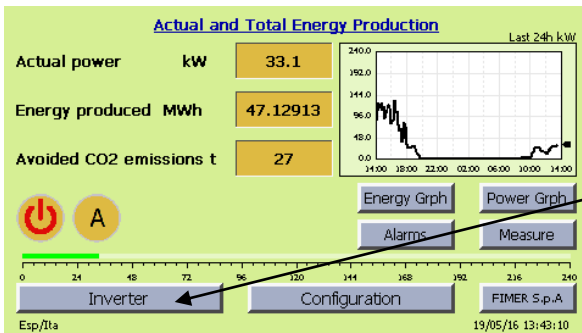

Press the “inverter” button (indicated by the arrow) to access the screen containing the calibration parameters of the inverter.

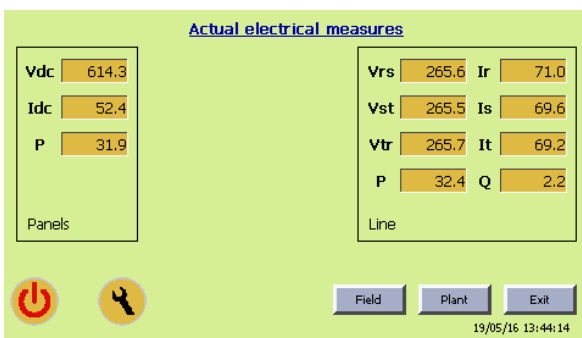

The measurements highlighted are the same as those described in the “Measurements” section. Authorised operators can access the calibration and configuration functions of the inverter via this screen: access to the relative menus is password protected.

## 15.6 Configuration

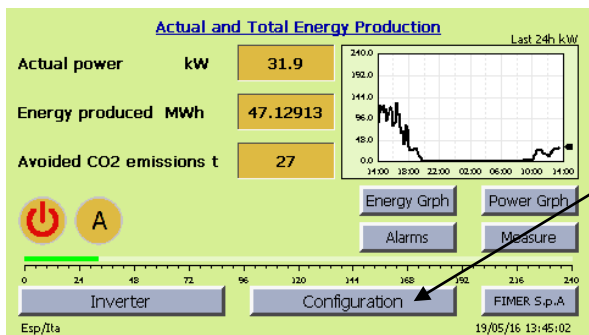

Press the “Configuration” button (indicated by the arrow) to access the screen for personalising the inverter.

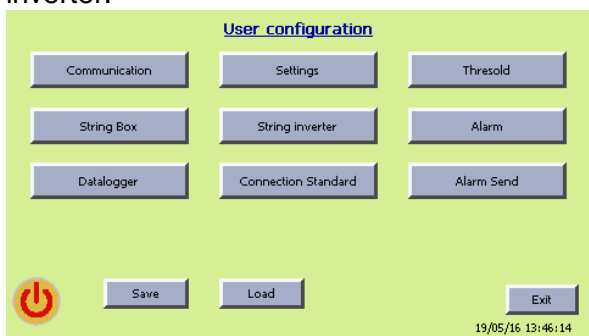

The following sections describe the screens corresponding to the buttons.

### 15.6.1 Communication

The screen allows configuring the MODBUS parameters for connecting to a third-party datalogger or to a display panel. “ModBus TCP Enable” flag enables a ModBus TCP server to allow data acquisition.

The protocol document for interrogating the inverter is available on request.

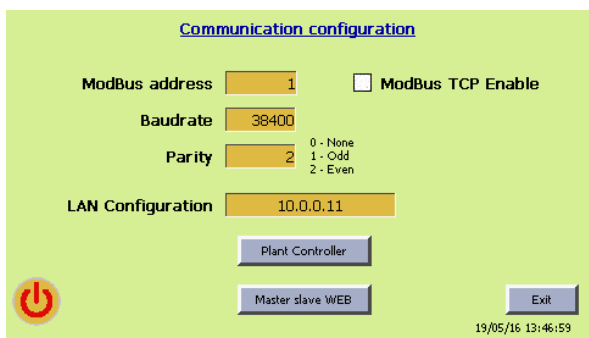

The LAN configuration can be changed. Press the box next to the words “LAN Setup” to close the application that manages the display for accessing the control panel of Windows CE. The “Network” function allows entering the network data necessary for making the functions of the inverter available through LAN/Internet.

At the end, close the control panel with the X located in the upper right hand corner of the screen and then press “Start Application” to go back to the inverter display page.

“Plant Controller” and “Master slave WEB” keys allows to enable and to configure respectively inverter remote control and a simple web server.



## 15.6.2 String Box

The two screens allow configuring the String Box.

Refer to the document “USER GUIDE FOR STRING BOX SBC FIMER” for the parameters and connections of the string boxes.

## 15.6.3 Datalogger

The screen allows entering the communication settings (email) for monitoring the inverter.

The “FIMERGuard” button allows automatically filling in the parameters to access FIMERGuard. The “Test” button runs a test on the reachability of the server and the functioning of the USB flash driver that stores the monitoring data, two separate windows show the results of the test. The “Send” button instantly sends the monitoring data.

## 15.6.4 Settings

**Impulses/kWh** allows setting the parameter of an energy meter outside the inverter to be used both as an additional measurement available in the inverter, and as data supplied to the FIMERGuard monitoring system.

**MPPT Scan** controls the frequency in minutes between one scan and another, the zero value disables the function.

**Alarm Temp** temperature threshold above which a “High Temperature” warning is triggered.

**Forced Ventilation** sets the percentage rotation fan speed when an overheating stop occurs.

**Time zone** allows defining and setting the time zone. Press the box next to the words “Time zone” to close the application that manages the display for accessing the control panel of Windows CE. The time zone can be changed using the “Date/Time” function.

At the end, close the control panel with the X located in the upper right hand corner of the screen and then press “Start Application” to go back to the inverter display page.

**Auto Update**, if checked, the clock is updated automatically by the FIMERGuard server. The “**Update**” button forces an immediate update of the clock.

### 15.6.5 String Inverter

Press the “String inverter” button to access the configuration sub-menu where series S and R string inverter for which you want to acquire data can be configured.

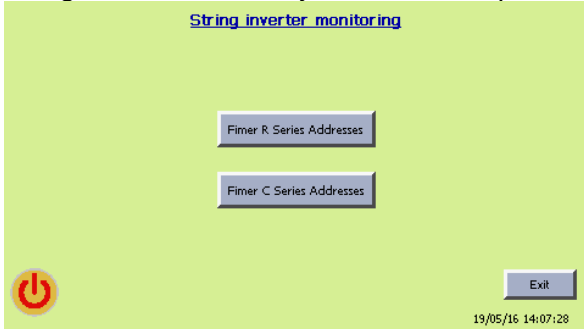

#### 15.6.5.1 FIMER Series R addresses

The screen allows entering the serial numbers of the Series R string inverters connected via Modbus for monitoring via FIMERGuard.

For the address, specify the second part of the serial number (xxxxx-yyyyy enter yyyyy), and then check the box on the side if dealing with a three-phase inverter.

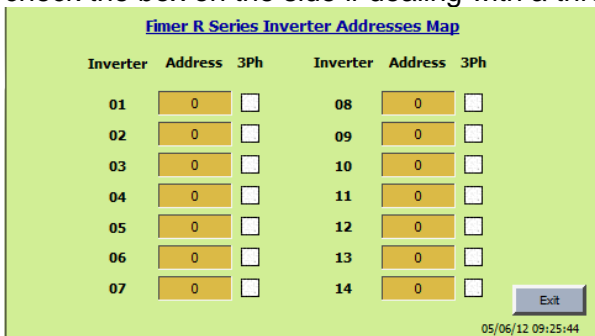

#### 15.6.5.2 FIMER Series C addresses

The screen allows entering the addresses of the Series C string inverters connected via Modbus for monitoring via FIMERGuard.

For the address, specify the personalised address using the special personalisation software for Series C inverters.

A zero value indicates an unused position.

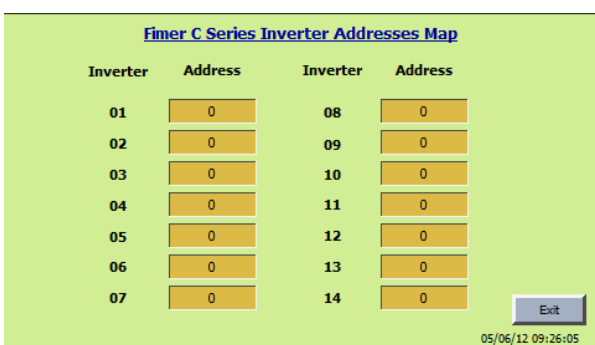

## 15.6.6 Thresholds

Threshold Configuration

W %   Expected power

tp, ta Δt low and high

kWp STC  W %/°C

Incentive €/kWh

Exit

19/05/16 14:14:39

The parameters indicate:

- W % maximum deviation between the actual power and the calculated power (data available only if a sensor box is present).
- Tp, ta maximum difference (high and low) between the temperature of the panels and the ambient temperature (only available if there is a sensor box and it can be disabled by keeping the values at zero)
- kWp STC rated power of the photovoltaic array connected to the inverter. The data is used to calculate the calculated power and to supply the power and energy measurements reported at the plant's peak output.
- W%/°C decrease in the available power relating to the temperature of the panels (which is reported in the datasheet of the panels).
- Incentive €/kWh

## 15.6.7 Alarms

This page allows setting the alarm functions.

Alarm Configuration

Stop when Insulation Loss

User alarm 1  0 - None  
1 - Alarm if closed  
2 - Alarm if open  
5 - Alarm if closed + stop  
6 - Alarm if open + stop

User alarm 2

Rele 1 logic  0 - Normal  
1 - Inverted

Rele 2 logic

Rele 3 logic

Rele 4 logic

Exit

19/05/16 14:16:34

“Stop when Insulation Loss” flag allows to stop the inverter if a pv field insulation loss condition is detected.

Alarms 1/2 allow setting the logics associated with the user alarm contacts present on the interface expansion board.

If the alarm is enabled and present, it will also be forwarded to FIMERGuard.

If the function selected also includes the Stop action, the inverter will be stopped for as long as the alarm persists.

Relay logics 1/2/3/4 allow changing the normal open and closed condition of the relays that signal the operating states of the inverter (contacts present on CN1 and CN2 of the interface).

## 15.6.8 Alarm Send

**Alarm Send Configuration**

From datalog@fimer-solar.com Fimer Guard

To datalog@fimer-solar.com

Smtip smtp.fimer-solar.com Auth

Subject Inverter name

Test Exit

05/06/12 09:29:06

The screen allows setting the parameters (email) for sending the alarm messages. The “FIMERGuard” button allows automatically setting the values required to report the alarms to FIMERGuard.

This function can be used independently from the monitoring software by entering the parameters provided by your internet provider. If necessary, the “Subject” field allows the immediate identification of the inverter if more than one is present.

Two emails will be sent for each alarm, one for the activation of the alarm (ON) and one at the end (OFF). The text message will contain the description of the alarm. The subject of the email will be: Alarm <serial number> <Subject>

## 16. TURNING OFF



To turn off the inverter, press this button from any screen:

You will be prompted to confirm your intention to shutdown the machine.

To secure the apparatus, open both the IDC and IAC switches (Figure 4) and wait 10 minutes to allow all the capacities contained in the apparatus to be discharged.

## 17. Maintenance

Replacement of machine parts is not expected for at least 10 years.

During this time, annual routine maintenance should be performed by checking the proper functioning and cleaning the apparatus, particularly the air inlets.

This maintenance interval is sufficient for a machine installed in a clean environment with a pollution degree not exceeding 2.

Operation in dusty or dirty environments may require more frequent maintenance.

The apparatus must not operate in humid environments with a saline, abrasive or explosive atmosphere.

After 10 years, extraordinary maintenance may be necessary with relative shutdown of the system for replacing some parts.

## 18. MECHANICAL DIMENSIONS

For the TL 1500V inverter the max mechanical dimensions are as follow described:

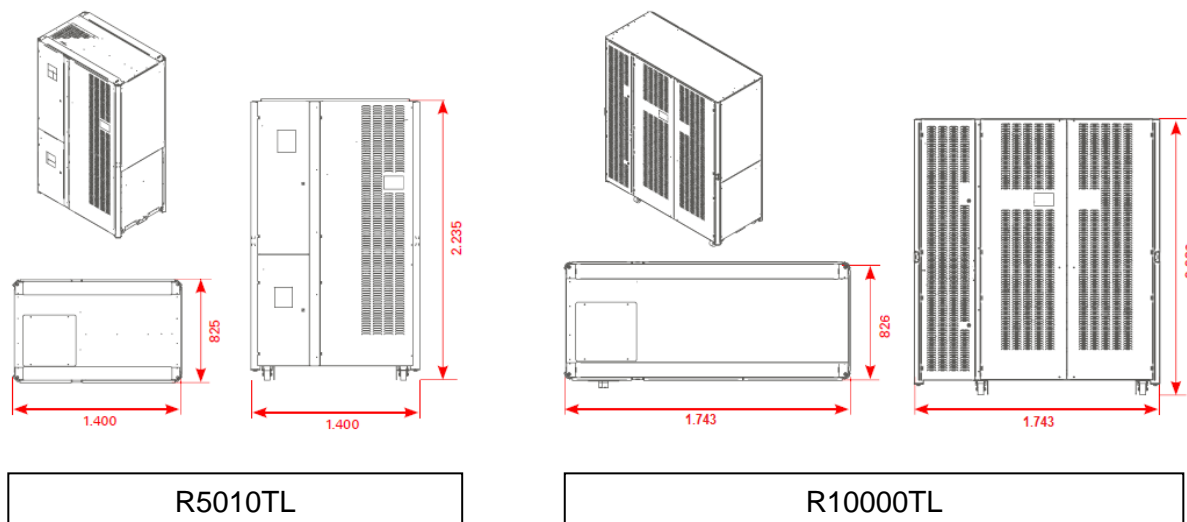

Concerning the inverter series R5010TL the details about mechanical dimensions are:

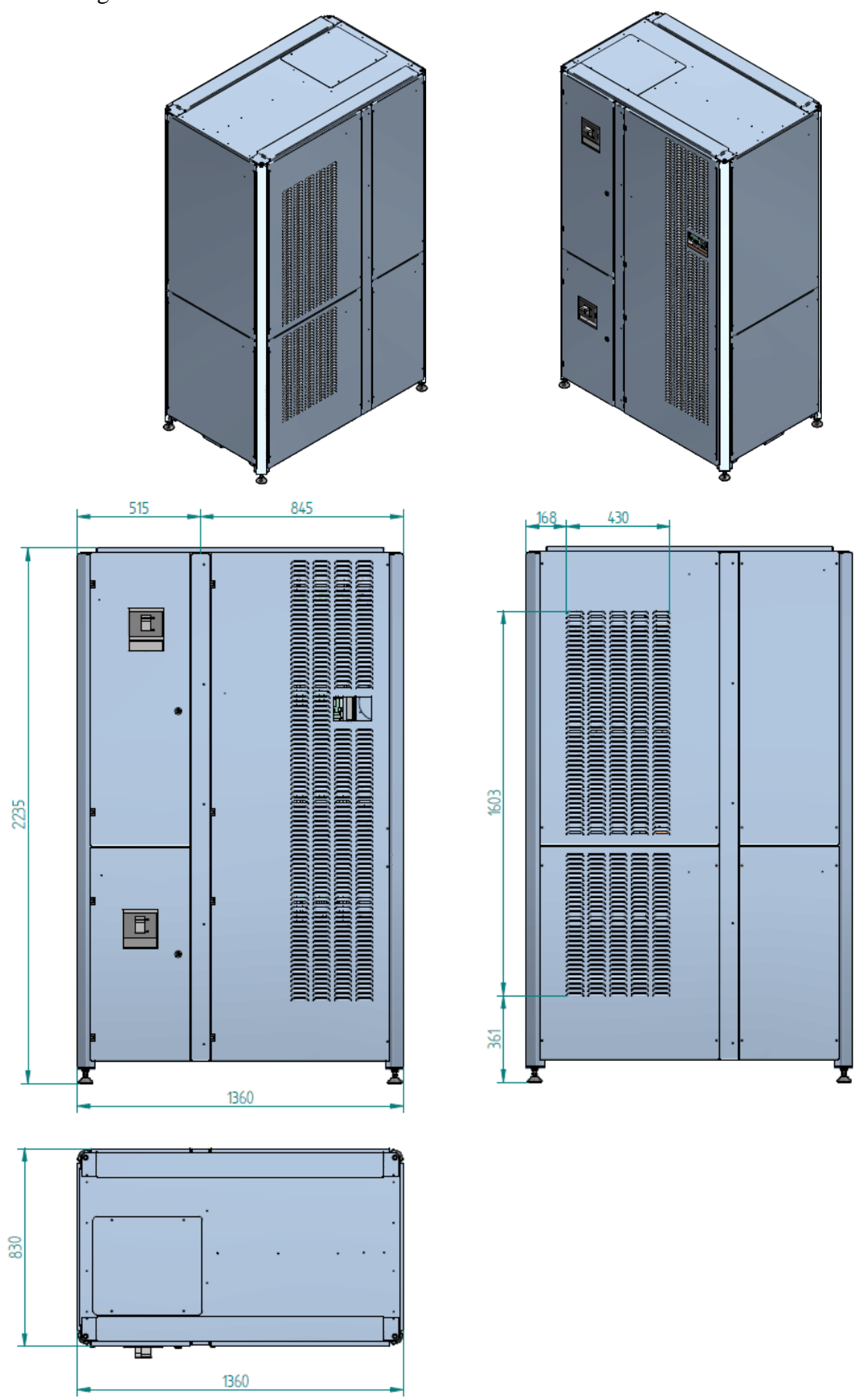

Concerning the inverter series R10000TL the details about mechanical dimensions are:

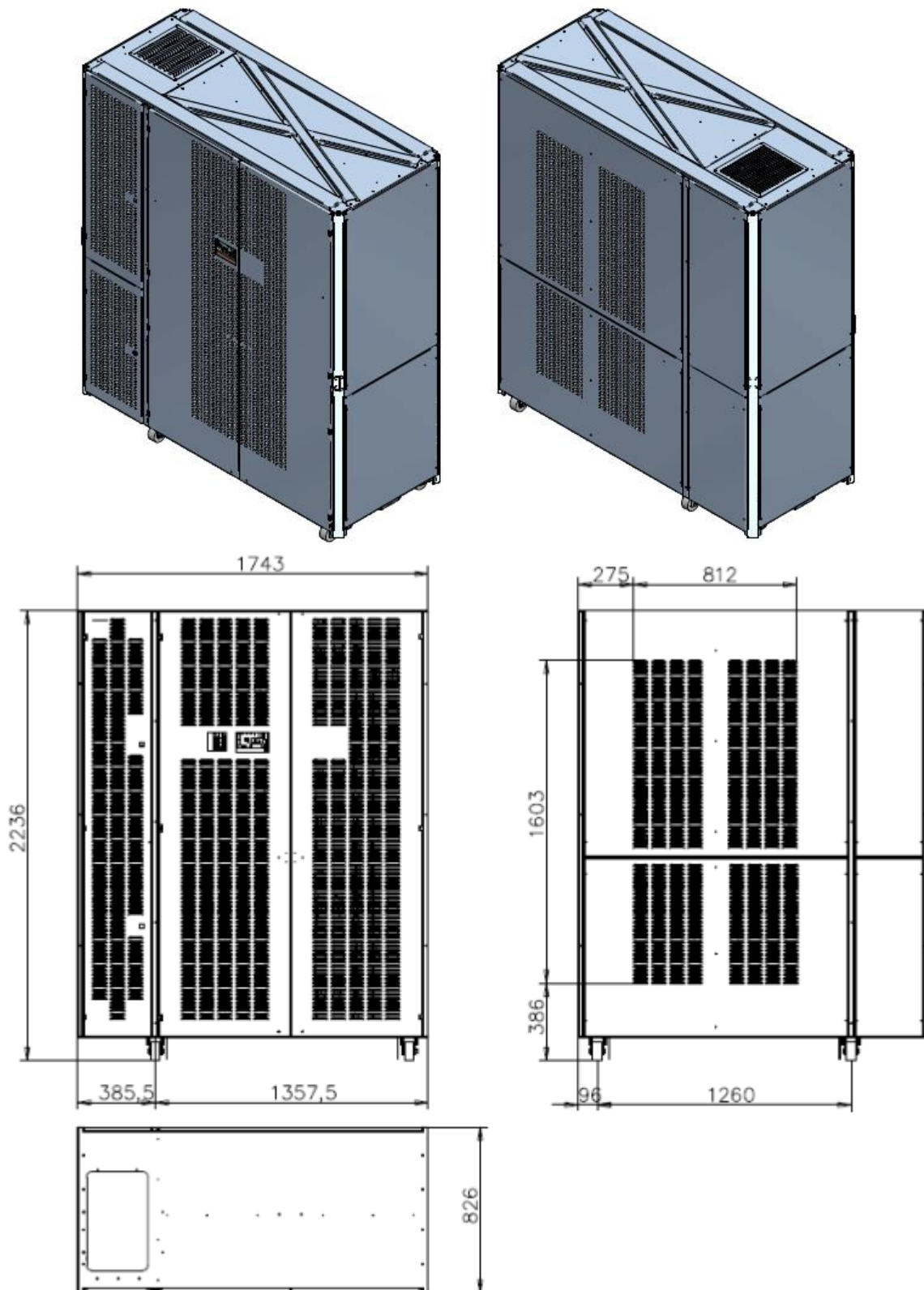

If the inverter is installed in a prefabricated cabinet (shelter-type), it is recommended to mechanically secure the inverters to the supporting structure. This can be done with the fastening screws of the eyebolts and the metal brackets.

# 19. MACHINE CONNECTIONS

The following figure shows the positions of the circuit breakers and / or switches both DC side and AC side. The customer does not occur to wire directly the cable on these switches, but on the copper bars which have up to four fixing holes. For the connection of both DC and AC cables use cable and the appropriate terminals (M12 terminal type) , for the ground wire cable use an appropriate terminals (M8 terminal type); these cables should be fixed with nut spring washer using split to ensure a seal and secure it to the appropriate hole provided on the earth bar

The following pictures describes the connection for all inverters because the connecting column is always the same:

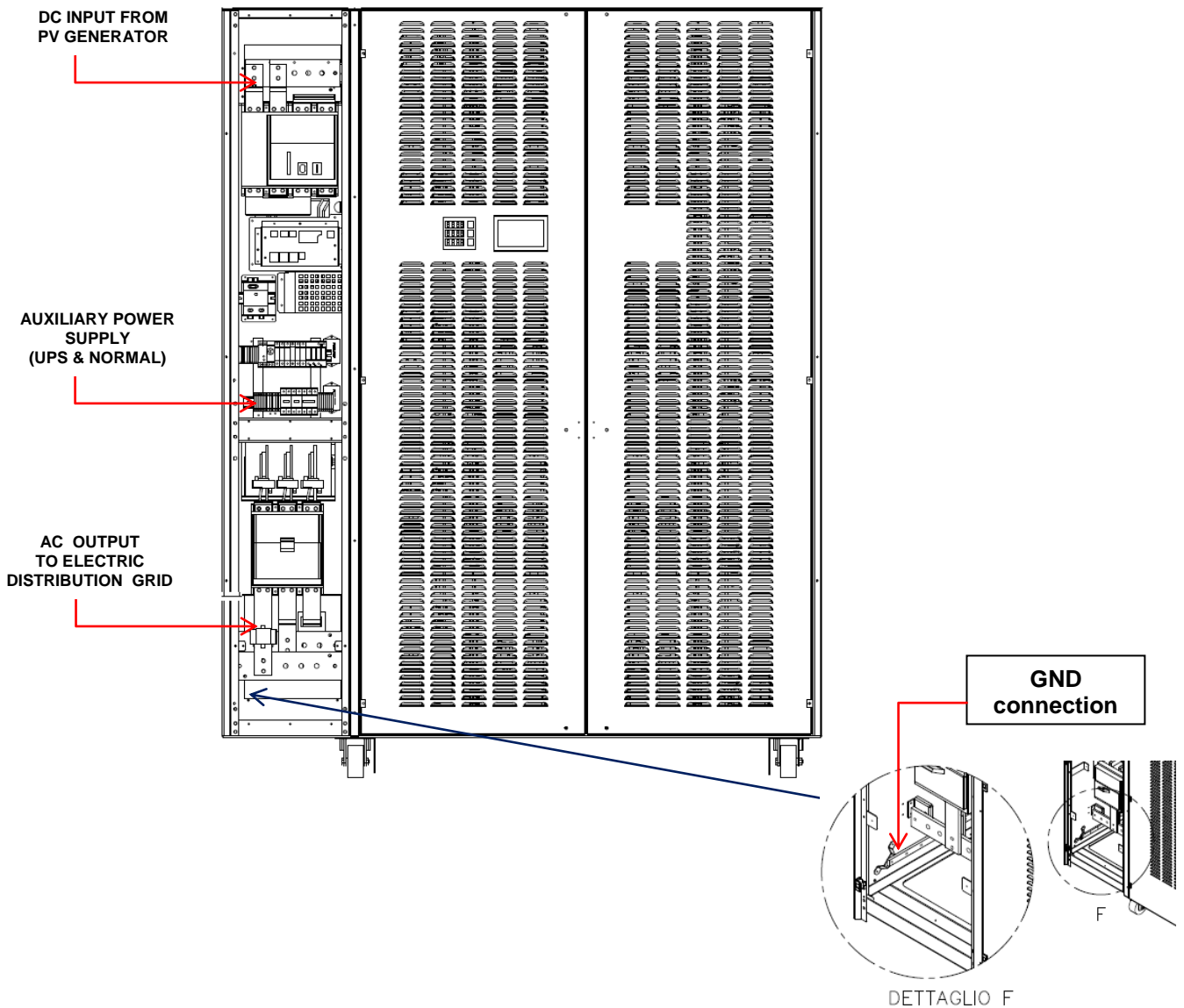



In the figure are listed the positions of the circuit breakers on both the DC and AC side. The bottom view also gives the information needed to predict any holes on the floor to lift the AC cables. The upper show how to plug the DC cables into the inverter.

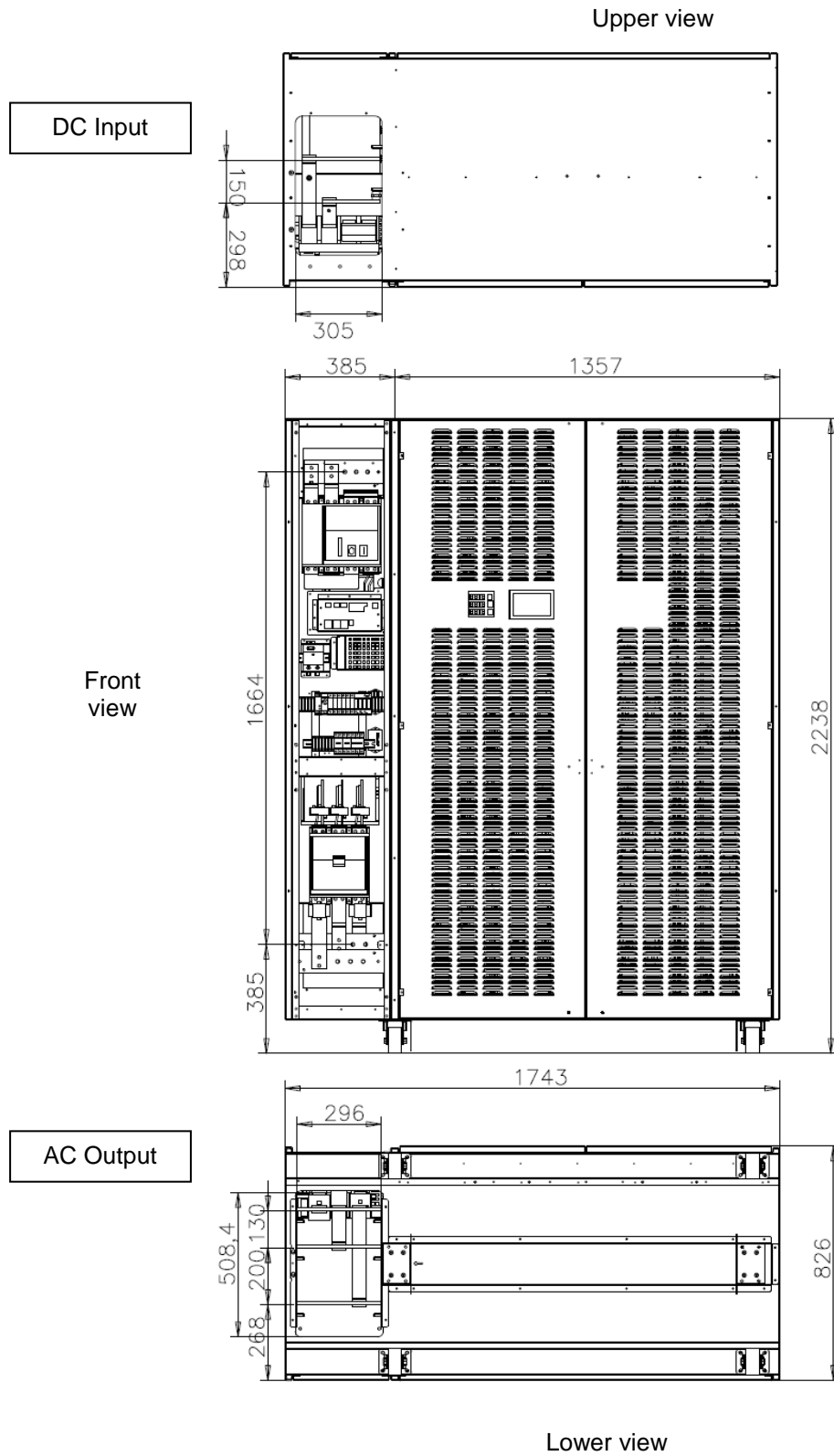

The following figure shows the details of DC and AC connections to the bars connecting the switches where has to be wired the cables.

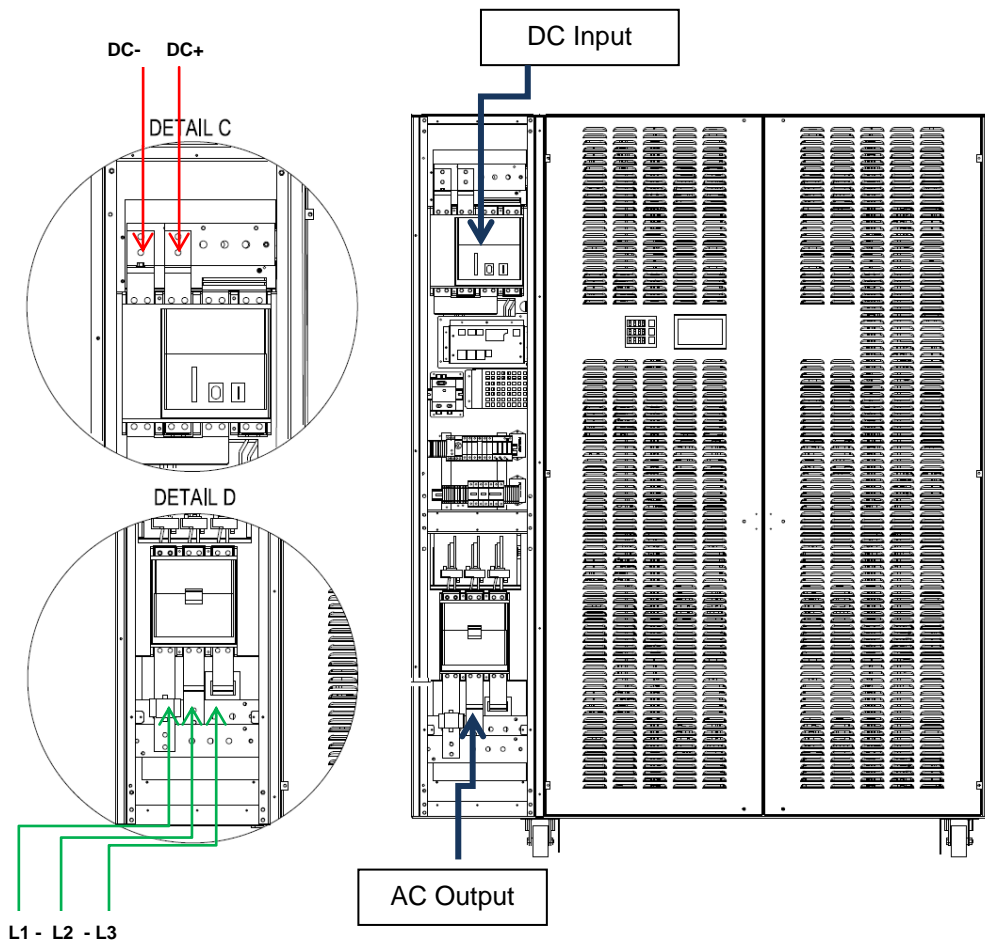

Notes:

1. The section of cable used to connect the ground wire to the FV converter must be at least equal to half of the sections of the cable used for the connection of the grid phases
2. Connect a single cable lugs to each of the terminals of the ground bar inside the inverter.
3. Connect a maximum of only two lugs per phase to the terminals of the bars connecting the PV inputs and outputs side AC

The following figure shows the details of the connections to the earth bar present inside the inverter.

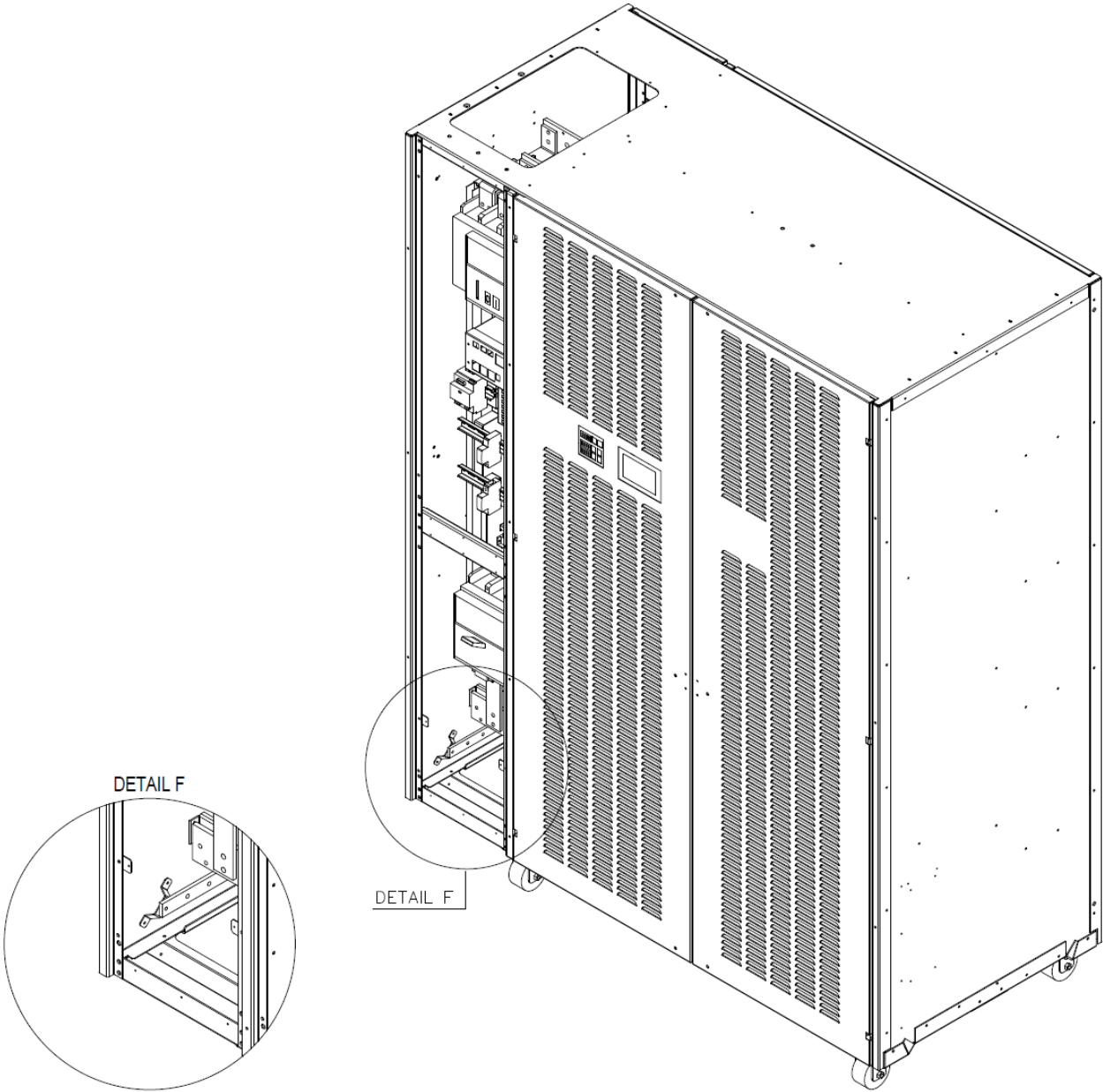

## 20. COOLING AIR FLOW AND CIRCULATION

In all FIMER central inverters without transformer for connection to MV Greed, the fresh air enters the inverter through the slits on the front doors of the equipment, the hot air exits through the vents instead of the rear wall of the inverter .

The air flow rate required to ensure the proper functioning of the inverter is indicated in the technical data of the individual converters (see Chapter 5 of this manual) and on the basis of these values it is therefore necessary that the air get in and get out in the room where the inverter is housed through the appropriate air inlet grille in order to meet the specifications of the inverter and ensure the proper operation of the machines; the air flow into the inverter is ensured by the presence of internal fans that work regulated in temperature, therefore the control electronics of the inverter increases the speed the fan in a manner directly proportional to the temperature measured inside the converter and the funs push the air from the front toward the rear of the inverter itself.

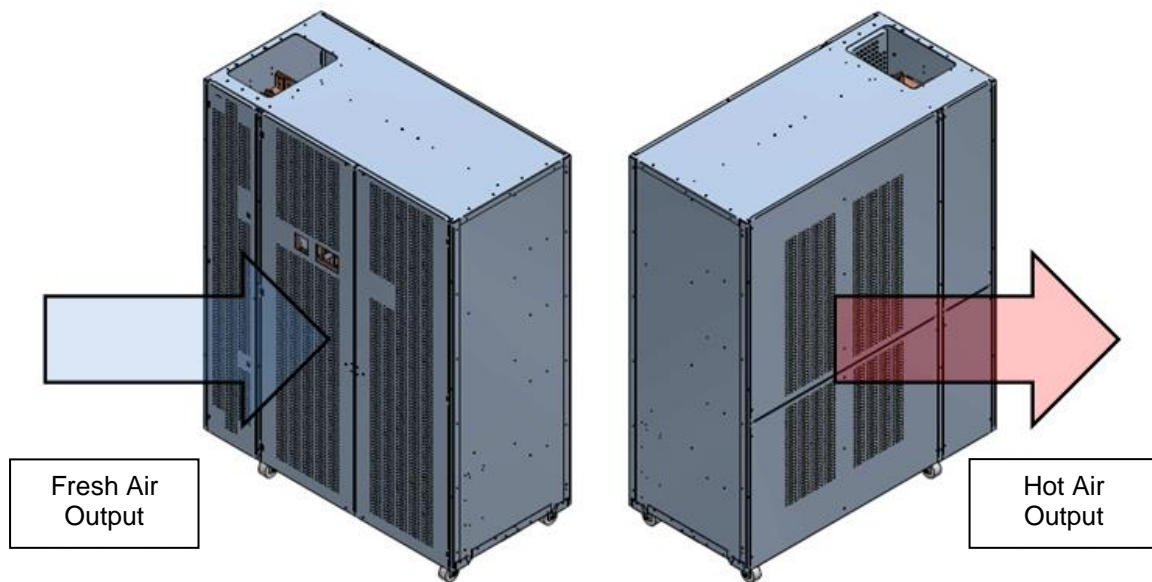

Based on the cooling air tour and on the cooling air flow described above it reiterates the need to ensure the distance from the ceiling and the wall of the room where the inverter is positioned as shown in Section 11.3 of this manual.

You may, however, subject to authorization by the inverter manufacturer and appropriate study by PV plant project engineer, provide for exceptions to the distances given in Section 11.3 through the implementation of appropriate passages or separation walls which prevent mixing the hot air and cold air and avoid the return of the hot air at the front of the inverter.

Only by operating in the manner just described and ensuring an air flow rate corresponding to the inverter in question it is able to ensure the perfect separation of the zone of fresh air from that for the hot air and the proper operation of the equipment.

# ANNEX 1: Technical specifications of the AC and DC surge arresters

## SPD on DC side

Class II surge arresters

### Type 2 surge arrester - VAL-MB-T2 1500DC-PV/2+V-FM - 2905646

Please be informed that the data shown in this PDF Document is generated from our Online Catalog. Please find the complete data in the user's documentation. Our General Terms of Use for Downloads are valid (<http://phoenixcontact.com/download>)



The figure shows the VAL-MB-T1/  
T2 1500DC-PV/2+V-FM version

Why buy this product



Key commercial data

Packing unit	1
GTIN	 4 046356 984195

Technical data

Dimensions

Height	120 mm
Width	71.2 mm
Depth	65.5 mm

Ambient conditions

Degree of protection	IP20 (only when all terminal points are used)
Ambient temperature (operation)	-40 °C ... 80 °C
Ambient temperature (storage/transport)	-40 °C ... 80 °C
Altitude	≤ 6000 m (amsl (above mean sea level))
Permissible humidity (operation)	5 % ... 95 %

General

Standards/specifications	EN 50539-11 2013
IEC test classification	PV T2
Number of ports	One
SPD failure behavior GRP	OCM (Open-circuit mode)
Connection configuration	Y configuration

06/04/2015 Page 1 / 4

# Type 2 surge arrester - VAL-MB-T2 1500DC-PV/2+V-FM - 2905646

## Technical data

### General

SPD design	Voltage-limiting type
Installation location	Inside
Accessibility	Accessible
Installation location of the disconnect device	Internal
Mode of protection	(L+) - (L-)
	(L+) - PE
	(L-) - PE
Mounting type	DIN rail: 35 mm
Color	traffic grey A RAL 7042
Housing material	PA 6.6
Pollution degree	2
Inflammability class according to UL 94	V-0
Type	Rail-mountable module, one-piece
Surge protection fault message	Optical, remote indicator contact

### Protective circuit DC voltage side (DC)

Maximum continuous operating voltage $U_{CPV}$	1500 V DC
Open circuit voltage $U_{OCSTC}$	$\leq 1250$ V DC
Short-circuit current rating $I_{SCPV}$	2000 A
Continuous operating current $I_{CPV}$	$< 55$ $\mu$ A
Rated load current $I_L$	50 A
Residual current $I_{FE}$	$\leq 55$ $\mu$ A DC
	$\leq 430$ $\mu$ A AC
Standby power consumption $P_c$	$\leq 85$ mVA
Nominal discharge current (8/20) $\mu$ s	20 kA
Maximum discharge current $I_{max}$ (8/20) $\mu$ s	40 kA
Total discharge current $I_{Total}$ (8/20) $\mu$ s	40 kA
Voltage protection level $U_p$	$\leq 4.5$ kV
Residual voltage $U_{res}$	$\leq 4.5$ kV (at $I_n$ )
	$\leq 3.3$ kV (at 3 kA)
	$\leq 3.6$ kV (at 6.25 kA)
	$\leq 3.8$ kV (at 10 kA)
	$\leq 4.2$ kV (at 15 kA)
	$\leq 5.4$ kV (at 40 kA)
Response time $t_A$	$\leq 25$ ns
Insulation resistance $R_{iso}$	$> 5$ G $\Omega$ (at 500 V DC)

### Indicator/remote signaling

Connection name	Remote fault indicator contact
Switching function	PDT contact
Operating voltage	5 V AC ... 250 V AC

## Technical data

### Indicator/remote signaling

	5 V DC ... 30 V DC
Operating current	5 mA AC ... 1.5 A AC
	5 mA DC ... 1 A DC
Connection method	Screw connection
Screw thread	M2
Tightening torque	0.25 Nm
Stripping length	7 mm
Conductor cross section flexible min.	0.14 mm <sup>2</sup>
Conductor cross section flexible max.	1.5 mm <sup>2</sup>
Conductor cross section solid min.	0.14 mm <sup>2</sup>
Conductor cross section solid max.	1.5 mm <sup>2</sup>
AWG conductor cross section	28 ... 16

### Connection data

Connection method	Screw connection
Conductor cross section flexible min.	2.5 mm <sup>2</sup>
Conductor cross section flexible max.	35 mm <sup>2</sup>
2 conductors with same cross section, stranded, ferrules without plastic sleeve, min.	2.5 mm <sup>2</sup>
2 conductors with same cross section, stranded, ferrules without plastic sleeve, max.	10 mm <sup>2</sup>
AWG conductor cross section	14 ... 2
Screw thread	M5
Tightening torque	3 Nm
Stripping length	16 mm
2 conductors with same cross section, stranded, ferrules without plastic sleeve, min.	2.5 mm <sup>2</sup>
2 conductors with same cross section, stranded, ferrules without plastic sleeve, max.	10 mm <sup>2</sup>

## Classifications

### eCl@ss

eCl@ss 5.1	27130801
eCl@ss 6.0	27130805

### ETIM

ETIM 3.0	EC000941
ETIM 4.0	EC000941

## Drawings

### Type 2 surge arrester - VAL-MB-T2 1500DC-PV/2+V-FM - 2905646

Circuit diagram

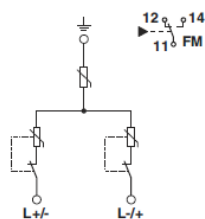

Dimensional drawing

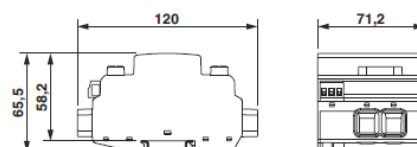

## SPD on AC side

### Type 2 surge protection device - VAL-MS 400/3+0/VF-FM/32 - 2909828

Please be informed that the data shown in this PDF Document is generated from our Online Catalog. Please find the complete data in the user's documentation. Our General Terms of Use for Downloads are valid (<http://phoenixcontact.com/download>)



Surge voltage arrester combination 3-channel, for mounting on NS 35/7.5, with remote indicator contact as PDT, voltage 400 V AC

#### Why buy this product

- ✓ For inverters and frequency inverters
- ✓ Can be used in 400 V IT systems

RoHS

#### Key Commercial Data

Packing unit	1
GTIN	 4 055626 383484
GTIN	4055626383484
Custom tariff number	85363010

#### Technical data

##### Dimensions

Height	98.7 mm
Width	71 mm
Depth	65.7 mm (incl. DIN rail 7.5 mm)
Horizontal pitch	4 Div.

##### Ambient conditions

Degree of protection	IP20 (only when all terminal points are used)
Ambient temperature (operation)	-40 °C ... 80 °C
Ambient temperature (storage/transport)	-40 °C ... 80 °C
Altitude	≤ 5000 m (amsl (above mean sea level))



## Technical data

### Ambient conditions

Permissible humidity (operation)	5 % ... 95 %
Shock (operation)	25g (Half-sine / 11 ms / 3x ±X, ±Y, ±Z)
Vibration (operation)	5g (10 ... 500 Hz / 2.5 h / X, Y, Z)

### General

IEC test classification	II
	T2
EN type	T2
Mode of protection	L-PE
	L-L
Mounting type	DIN rail: 35 mm
Color	jet black RAL 9005
Housing material	PA 6.6
	PBT
Degree of pollution	2
Flammability rating according to UL 94	V-0
Type	DIN rail module, two-section, divisible
Number of positions	4
Surge protection fault message	Optical, remote indicator contact

### Additional descriptions

Note	Burst test up to 4 kV passed according to DIN EN 61000-4-4.
	Insulates against repetitive pulses up to 1.5 kV.
	Only usable in IT Systems between L-PE, if the exposed-conductive-parts (bodies) of the equipment of the low-voltage installation is connected to the earthing arrangement of the transformer substation (interconnected earthing arrangement of the HV-transformer substation with the bodies of the LV-installation. $R_E = R_A$ accordance to IEC 60364-4-442 / VDE 0100-442 Fig. 44D / Example a).
	At altitudes > 2000 m (amsl), a lateral distance of 2 mm must be maintained between live and grounded parts.

### Protective circuit

Nominal voltage $U_N$	400 V AC (IT)
Nominal frequency $f_N$	50 Hz (60 Hz)
Maximum continuous voltage $U_C$	440 V AC
Rated load current $I_L$	80 A
Residual current $I_{PE}$	$\leq 5 \mu A$
Standby power consumption $P_C$	$\leq 600 \text{ mVA}$
Nominal discharge current $I_n$ (8/20) $\mu s$	20 kA

### Protective circuit

Maximum discharge current $I_{max}$ (8/20) $\mu s$	40 kA
Short-circuit current rating $I_{SCCR}$	25 kA
Voltage protection level $U_p$ (L-L)	$\leq 4$ kV
Voltage protection level $U_p$ (L-PE)	$\leq 3.5$ kV
Residual voltage $U_{res}$ (L-L)	$\leq 4$ kV (at $I_n$ )
Residual voltage $U_{res}$ (L-PE)	$\leq 2.3$ kV (at $I_n$ )
Response time $t_A$ (L-L)	$\leq 25$ ns
Response time $t_A$ (L-PE)	$\leq 100$ ns
Max. backup fuse with V-type through wiring	80 A (gG)
Max. backup fuse with branch wiring	100 A (gG)

### Indicator/remote signaling

Switching function	PDT contact
Operating voltage	5 V AC ... 250 V AC (Altitude $\leq 2000$ m amsl)
	5 V AC ... 150 V AC (Altitude $> 2000$ m amsl)
	30 V DC
Operating current	5 mA AC ... 750 mA AC
	1 A DC
Connection method	Plug-in/screw connection via COMBICON
Screw thread	M2
Tightening torque	0.25 Nm
Stripping length	7 mm
Conductor cross section flexible	0.14 mm <sup>2</sup> ... 1.5 mm <sup>2</sup>
Conductor cross section solid	0.14 mm <sup>2</sup> ... 1.5 mm <sup>2</sup>
Conductor cross section AWG	28 ... 16

### Connection data

Connection method	Screw connection
Screw thread	M5
Tightening torque	3 Nm (1,5 mm <sup>2</sup> ... 16 mm <sup>2</sup> )
	4.5 Nm (25 mm <sup>2</sup> ... 35 mm <sup>2</sup> )
Stripping length	16 mm
Conductor cross section flexible	1.5 mm <sup>2</sup> ... 25 mm <sup>2</sup>
Conductor cross section solid	1.5 mm <sup>2</sup> ... 35 mm <sup>2</sup>
Conductor cross section AWG	15 ... 2
Connection method	Fork-type cable lug
Conductor cross section flexible	1.5 mm <sup>2</sup> ... 16 mm <sup>2</sup>

### Standards and Regulations

Standards/regulations	IEC 61643-11 2011
	EN 61643-11 2012

### Drawings

Dimensional drawing

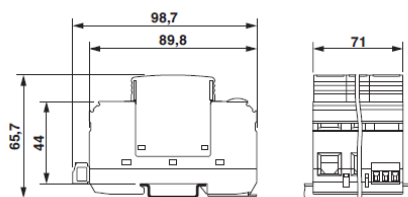

Circuit diagram

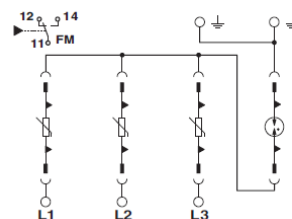

## ANNES 2: Notes on the design and dimensioning of MV / LV transformers.

Please note that using central inverters FIMER TL - series without transformer is necessary to use MV / LV transformers with multiple secondary connections (LV) to link to connect separately each of these inverters TL - series without transformer.

**Must always be present the screen between the MV winding of and that / those LV windings**

It requires that the secondary windings (LV connections) are not overlapping each other:

### Construction recommended:

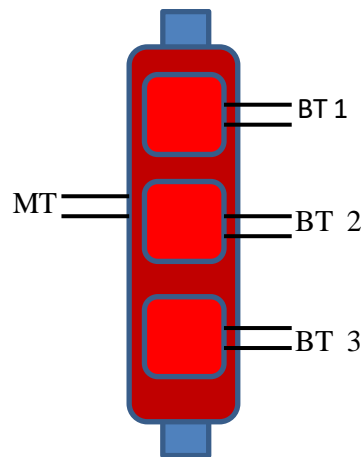

### Construction not recommended:

This configuration does not guarantee a real decoupling and interference between the inverters and may have to be used a possible additional capacitor bank which avoids any interference between the inverters

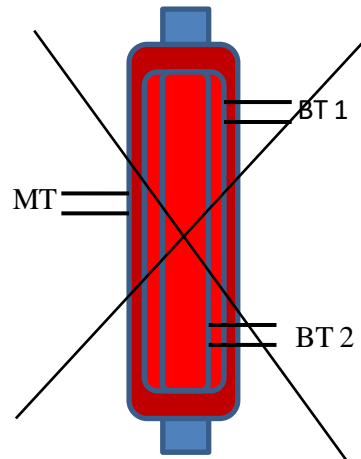

## **ANNEX 3: Preventive and periodic maintenance of central inverters**

FIMER recommend to their customers to comply with a correct and constant preventive maintenance of solar inverters, so that we can maximize the reliability of service and minimize repair costs not included.

Through proper preventive maintenance, the availability of solar inverters has lengthened the life cycle.

### **Preventive maintenance**

Preventive maintenance if has not been delegated to a separate and appropriate maintenance contract with the inverter manufacturer is usually borne by the client, to whom are entrusted all the operations of periodic verification. By qualified service personnel may be carried out of the routine operations that can assess the state of the drive, with a frequency of intervention that varies according to the environmental conditions in which the drive is installed. In Italy an average of two visits per year of preventive maintenance are recommended, including the controls of all the parts that make up the system including any replacement of consumables.

As regards the inverter Centralized FIMER, preventive maintenance includes the following procedures:







- Visual inspection of the inverter.
- Cleaning of the external structure with a focus on air path.
- Cleaning inside the inverter to remove dust, pollen and all kinds of dirt introduced in the equipment and that could damage the electronic cards or disrupt the operation of the fans.
- Verification of the working temperature of the converter in order to assess the proper ventilation of the room in which you installed the converter.
- Check suitability of the premises (excluding water infiltration, pollen or rodents).
- Check the safety devices of the converter.
- Check the connections are tightened to exclude loose wires that could cause overheating.
- Control any water infiltration or condensation.



At each periodic maintenance is recommended to simulate the separation of the mains supply: inverter / inverters must / will instantly shut down, up again after the return of the network signal.

**It is recommended to perform the inspection and maintenance only by personnel trained or qualified.**



We remind all operators authorized to carry out maintenance that before entering the converter be sure to be aware of the safety regulations specified in manual and control all of the personal protective equipment required by the manufacturer

	<i>When installing or servicing the drive in a yard with suspended materials handling wear helmet.</i>
	<i>Wear appropriate protective gloves before working on the drive.</i>
	<i>Wear appropriate shoes that can prevent accident to guard against falling heavy objects.</i>
	<i>In the event of prolonged exposure to noise wear hearing protection devices.</i>
	<i>Be careful! Before performing any maintenance, disconnect the inverter from the grid line and from the PV field.</i>
	<i>Be careful! Wear protective eye when performing any type of maintenance.</i>

OPERATION		DESCRIPTION	RESULT AND SIGNATURE	
			POSITIVE	NEGATIVE
		“Operations of periodic inspection of central inverter”		
1	<b>Ambient condition</b>	Verify that the general conditions of the environment are specified by the manufacturer to ensure the perfect and continuous operation of the drive.		
2	<b>General condition of the inverter</b>	Check the external condition of the inverter: cleaning, damage to the "case" and that the general conditions of maintenance are good.		
3	<b>Air flow</b>	Check the operation and efficiency of the ventilation device (test of the thermostat). Check that the inlet fresh air and hot air exhaust are not blocked.		
4	<b>Condition of filter for ventilation</b>	Check the status of any filters installed on the ventilation unit of the drive or the room where it is installed.		
5	<b>Infiltration</b>	Check for any signs of infiltration of liquid in the area around or on the converter and in the case restore the isolation of the local as soon as possible.		
6	<b>Manumission</b>	Verify that there are no signs of tampering or theft to the converter, so that they may have changed the specifications.		
7	<b>Display</b>	<b>Check the operation of Display: Status pixels, color and operation of the software of the inverter.</b>		
		<p><b>WARNING! To continue to inspect the inverter you should be qualified and licensed by FIMER S.p.A.</b></p> <p><b>Isolate the inverter from the grid and from the PV array by opening the VDC and VAC switch or breakers contained in the inverter cabinet.</b></p> <p><b>Wait 20min before entering any maintenance in the cabinet top. It is necessary to wait for the discharging of the capacitors before doing any other type of operation. In the form of precaution also open the switches on the DC side of the 2 ° Parallel Panel</b></p>		
8	<b>DC Switch</b>	Check the tightness of power connections and the isolation of individual connections.		
9	<b>Source Protection Device</b>	Check the integrity of the AC and DC side surge, visually checking the appropriate warning.		
10	<b>Fuse</b>	Check the integrity and the perfect condition of the fuses.		
11	<b>AC Switch</b>	Check the tightness of power connections and the isolation of individual connections of the AC main switch and of all the contactors inside the inverter.		
12	<b>Electronic cards</b>	Check the connection status of each board by disconnecting and reconnecting the Bus, Flat and connectors.		
13	<b>Inverter</b>	Visual inspection of the inverter and their ventilation if possible GENTLY blow with compressed air to clean dust from heat sinks, fans and inverter (before blowing ensure that there is no moisture in the air line of the compressor).		
		<p><b>Reconnect the drive to the grid and to the photovoltaic field to continue the testing procedure. Tests to follow can only be made under the presence of sunlight and electric grid.</b></p>		

14	<b>Functional test of modules and electronic cards</b>	Turning ON the power of the inverter in manual mode at minimum power allowed by the size of the inverter installed. Verify that all fans, modules and electronic boards work properly without working alarm display and LED on the board.		
15	<b>Restoration</b>	Turn off the inverter and close the front panels		
16	<b>Operating test of the inverter</b>	Start up the inverter in automatic mode.		

## PV Inverter

PV Inverter datasheet    Year _____    SN MEGASTATION _____    datasheet consecutive no. _____ PV inverter: (Routine maintenance requires to put the system out of service and will only concern the parts of the plant directly served by them)					
N.B. Refer to the manufacturers' datasheets, if existing or available. Operations are performed after visual and / or instrumental inspection.		Maximum frequency	Performed on	Signature	Measures taken or suggested
1	<b>INVERTER</b> – Checks / interventions: Check the external part of the inverter: cleanliness, any damage to the case, and good conditions of maintenance	Yearly			
2	<b>INVERTER</b> – Checks / interventions: Check plate data	Yearly			
3	<b>INVERTER</b> – Checks / interventions: Check the operation and efficiency of the ventilation device by performing functional tests and reading temperature on the display. Check that the fresh air inlet and hot air exhaust are not blocked	Yearly			
4	<b>INVERTER</b> – Checks / interventions: Check for signs of infiltration of liquids or condensation in or around the inverter and restore room insulation as necessary as soon as possible; prevent pollen or rodent infiltration	Yearly			
5	<b>INVERTER</b> – Checks / interventions: Verify that there are no signs of tampering or damage on the inverter, which may have altered the technical specifications	Yearly			
6	<b>INVERTER</b> – Checks / interventions: Clean the inside of the inverter to remove traces of dust, pollen and all kinds of dirt introduced in the equipment and that may damage electronic boards or disrupt the operation of the fans	Yearly			
7	<b>INVERTER</b> – Checks / interventions: Check the inverter safety devices	Yearly			
8	<b>INVERTER</b> – Checks / interventions: Check the tightness of power connections and the isolation of individual connections	Yearly			
9	<b>INVERTER</b> – Checks / interventions: Check the integrity of the existing arresters by visually checking the appropriate indicator	Yearly			
10	<b>INVERTER</b> – Checks / interventions: Check the integrity and perfect condition of fuses	Yearly			
11	<b>INVERTER</b> – Checks / interventions: Check the operation of the display: state of pixels, colour and operation of inverter management software	Yearly			
12	<b>INVERTER</b> – Checks / interventions: Check the connections of circuit breakers and contactors of individual modules and the perfect isolation of each connection	Yearly			
13	<b>INVERTER</b> – Checks / interventions: Check the connection status of each board by checking the correct fastening of the cable connectors and Flat cables	Yearly			
14	<b>INVERTER</b> – Checks / interventions: Visual inspection of the inverters and their ventilation: if possible GENTLY blow with compressed air to remove dust from heat sinks, fans, and power modules (before blowing make sure that there is no condensation in the air line of the compressor)	Yearly			
15					
<b>NOTES:</b>					<b>Maintenance technician signature</b>



## ANNEX 4: Troubleshooting

ALARM CODE		DESCRIPTION	POSSIBLE SOLUTION
1	AD Trim Zero KO	Trouble in the reading of tension	Check all the wires connections on the electronic cards of the modules. If the problems persist contact the FIMER Service.
2	Alim KO 24V	No 24Vdc from the DC pack	Check the status of the auxiliary switches VAUX( they must to be closed ) or the presence of the auxiliary line supplied from the auxiliary transformer ***
3	User alarm 1	Programmable input alarm: it informs about a fault coming from an external device	Check the status of the device connected at the input or the connection with the expansion electronic card.
4	User alarm 2	Programmable input alarm: it informs about a fault coming from an external device	Check the status of the device connected at the input or the connection with the expansion electronic card.
5	Monitoring production alarm	Warning of low productivity : value compared with the estimated production obtained through the radiation sensor	Verify the string currents and the cleaning of the PV modules
6	Dangerous current	Dangerous current measured in the strings boxes	One of the strings has reached a dangerous value of current. Check the string currents values for identify which is the one with the over current problem.
7	No calibration	Missing motherboard calibration	Contact the FIMER Service
8	No configuration	Missing motherboard configuration	Contact the FIMER Service
9	EPO - emergency	Alarm Emergency Power Off : contact CN3 open ( emergency shoot down )	If connected with the inverter verify the Emergency Power Off otherwise check the bridge on the connection CN3 of the inverter
10	Ventilator module xxx ( fan )	Alarm of the ventilator: the fan doesn't work or the motherboard's input is broken and it can be driven..	Control the status of the fan: with module in running the fan must be in activity

ALARM CODE		DESCRIPTION	POSSIBLE SOLUTION
11	Tension close to the limit	The tension relieved is close to the limit set	Check the values the three phases: if they are close to the limit also when the inverter is off it must to control the transformer, if the phases values are close to the limit only when the inverter is running, please contact the FIMER service
12	Service degraded	A module has not activated after at least three tries. The module has been disengaged	If the problem persist contact the FIMER service
13	DC lost of insulation	Lost of insulation has been felt from the inverter. The "grounding kit" fuse is burned because a current over his limit.	Control the grounding kit fuse and replace it in case the it is burned. In case the new fuse burn just after the new replacement, contact the FIMER service.
14	Modxxx AD Auto Zero KO	The module motherboard has a problem in the zeroing of the parameters	Check all the wires connections on the electronic cards of the modules. It the problems persist contact the FIMER Service.
15	Modxxx Alim KO 24V	No 24Vdc from the module DC pack	Check the status of the auxiliary switches VAUX( they must to be closed ) or the presence of the auxiliary line supplied from the auxiliary transformer ***
16	Modxxx Condensator KO	The module motherboard has received a wrong tension value	Check all the wires connections on the electronic cards of the modules. It the problems persist contact the FIMER Service.
17	Modxx no calibration	Trouble with the module motherboard calibration	Contact the FIMER Service
18	Modxxx Assenza configurazione	No configuration of the modules	Contact the FIMER Service
19	Modxxx Eeprom Fault	Troubles with the motherboard Eprom	Contact the FIMER Service
20	Modxxx Overcurrent R	Over current in the first phase	Check the connections of the automatic breaker of the module in error but only in order to inform the FIMER service on his general statement. If everything it's fine restart the inverter for a second try, it could be possible that the overcurrent has been felt from the inverter for a temporary peak. If the problem will repeat inform the FIMER service

ALARM CODE		DESCRIPTION	POSSIBLE SOLUTION
21	Modxxx Overcurrent S	Over current in the second phase	Check the connections of the automatic breaker of the module in error but only in order to inform the FIMER service on his general statement. If everything it's fine restart the inverter for a second try, it could be possible that the overcurrent has been felt from the inverter for a temporary peak. If the problem will repeat inform the FIMER service
22	Modxxx Overcurrent T	Over current in the third phase	Check the connections of the automatic breaker of the module in error but only in order to inform the FIMER service on his general statement. If everything it's fine restart the inverter for a second try, it could be possible that the overcurrent has been felt from the inverter for a temporary peak. If the problem will repeat inform the FIMER service
23	Modxxx Overtemperature Mag1	Over temperature of the magnetic ( <u>transformer</u> - only if the inverter is equipped with it )	Check the connection named "J17" on the module motherboard ( not present on the inverter R15015TL or however in to the inverters transformerless ). If the cable coming from the temperature sensor ( the red one ) that is fitted in the magnetic is well connected, the problem could be of overtemperature. Contact the service FIMER
24	Modxxx Overtemperature Mag2	Over temperature of the magnetic ( inductance )	Check the connection named "J16" on the module motherboard. If the cable coming from the temperature sensor ( the grey one ) that is fitted in the magnetic inductor is well connected, the problem could be of overtemperature. Contact the service FIMER
25	Modxxx Overtension RS	Over tension measured between phases RS	Verify the value of the three phases: it must be around 550Vac. In case the values of the phases are fine, check the connections of the automatic breaker of the module in error but only in order to inform the FIMER service on his general statement. If everything it's fine restart the inverter for a second try, it could be possible that the overtension has been felt from the inverter for a temporary peak. If the problem will repeat inform the FIMER service

ALARM CODE		DESCRIPTION	POSSIBLE SOLUTION
26	Modxxx Overtension ST	Over tension measured between phases ST	Verify the value of the three phases: it must be around 550Vac. In case the values of the phases are fine, check the connections of the automatic breaker of the module in error but only in order to inform the FIMER service on his general statement. If everything it's fine restart the inverter for a second try, it could be possible that the overtension has been felt from the inverter for a temporary peak. If the problem will repeat inform the FIMER service
27	Modxxx Overtension TR	Over tension measured between phases TR	Verify the value of the three phases: it must be around 550Vac. In case the values of the phases are fine, check the connections of the automatic breaker of the module in error but only in order to inform the FIMER service on his general statement. If everything it's fine restart the inverter for a second try, it could be possible that the overtension has been felt from the inverter for a temporary peak. If the problem will repeat inform the FIMER service
28	Modxxx Overtension UDC	Over tension in the continue tension DC	Check the value of the tension VDC and if this is in the normal range ( around 850-1320 Vdc ) try a restart of the inverter. In case the alarm will happen again contact the FIMER service.
29	Modxxx Power OFF KO	Troubles in the driving of DC pack of the module	Verify the presence of the auxiliary line and/or the working of the DC pack of the module: in case both are ok, contact the FIMER service
30	Modxxx Rampa KO	The module cannot finish the start procedure: problem in the reading of values	Check all the wires connections on the electronic cards of the modules. If the problems persist after a restart, contact the FIMER Service.
31	Modxxx IGBT KO	The module doesn't start because problem in the IGBT drivers: general alarm	Check all the wires connections on the electronic cards of the modules. If the problems persist after a restart, contact the FIMER Service.
32	Modxxx lost of synchronism	Problem of connection between the Supervisor and the module motherboard	Check the connection between the modules electric card and the supervisor, the cable of which verify the connection is the flat one multicolour. If after the verify the problem persist, contact the FIMER service.

ALARM CODE		DESCRIPTION	POSSIBLE SOLUTION
33	Modxxx Over temperature	Limit temperature of the module	The IGBT module has reach the limit of temperature. Try a restart but if the problem persist, contact the FIMER service.
34	Modxxx undertension RS	Under tension measured between phases RS	Verify the value of the three phases: it must be around 550Vac. In case the values of the phases are fine, check the connections of the automatic breaker of the module in error but only in order to inform the FIMER service on his general statement. If everything it's fine restart the inverter for a second try, it could be possible that the undertension has been felt from the inverter for a temporary peak. If the problem will repeat inform the FIMER service
35	Modxxx under tension ST	Under tension measured between phases ST	Verify the value of the three phases: it must be around 550Vac. In case the values of the phases are fine, check the connections of the automatic breaker of the module in error but only in order to inform the FIMER service on his general statement. If everything it's fine restart the inverter for a second try, it could be possible that the undertension has been felt from the inverter for a temporary peak. If the problem will repeat inform the FIMER service
36	Modxxx under tension TR	Under tension measured between phases TR	Verify the value of the three phases: it must be around 550Vac. In case the values of the phases are fine, check the connections of the automatic breaker of the module in error but only in order to inform the FIMER service on his general statement. If everything it's fine restart the inverter for a second try, it could be possible that the undertension has been felt from the inverter for a temporary peak. If the problem will repeat inform the FIMER service

***Encodings reporting related to individual modules can be generated with different numbers to depending on the module on which the anomaly was detected. In case of warning with red symbol and acoustic alarm that is not possible to recognize (as described in the instructions for use), please contact the Service FIMER.***

## ANNEX 5: Norms and requirement for connecting the inverter to the national grid and parameter setting

This Appendix in object is intended to illustrate to a skilled person, in the possession of a request of the grid distributor, how to implement the requested services.

For a description of the meaning of the parameters and modes of operation, please refer to the official documentation valid for the market where the inverter has to be installed

(e.g. VDE-AR-N-4105:2011-08 for German market; CEI-021 and CEI016 for Italian Market, "Norma tehnică "Condiții tehnice de racordare la rețelele electrice de interes public pentru centralele electrice fotovoltaice" din 17.05.2013" for the Romanian market ).

### Parameter Setting

From the main page of the display of the inverter select the menu (Button) "Configuration" and then "Connection standard"

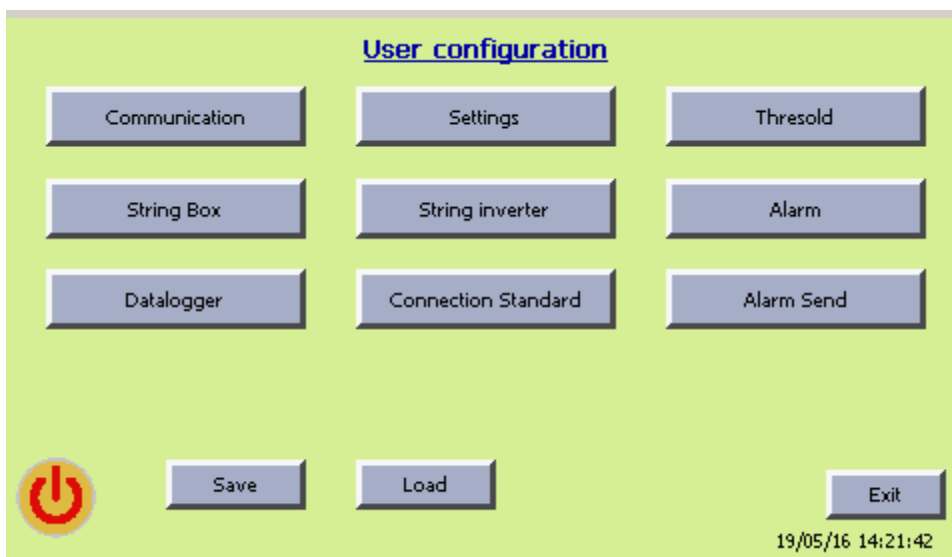
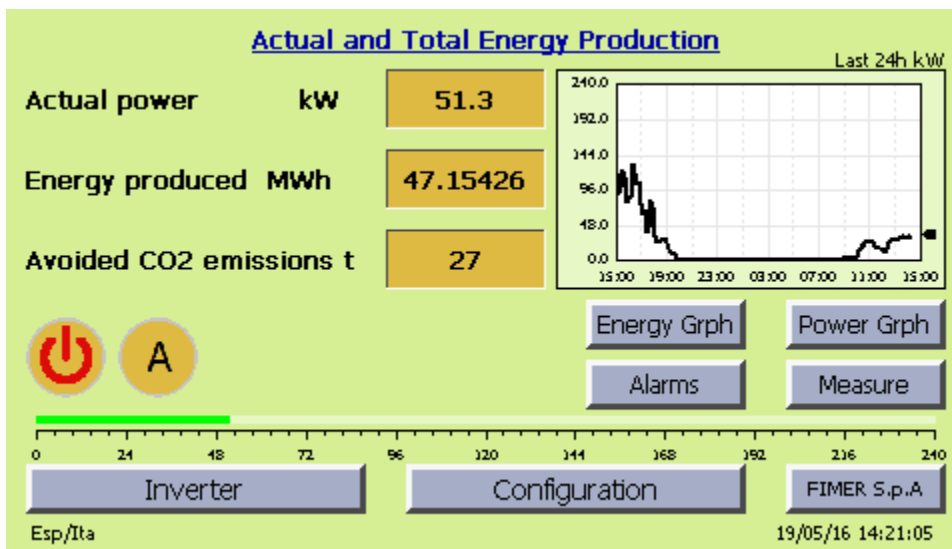

On the screen it will appear the page where are resumed all the different setting related to the grid services:

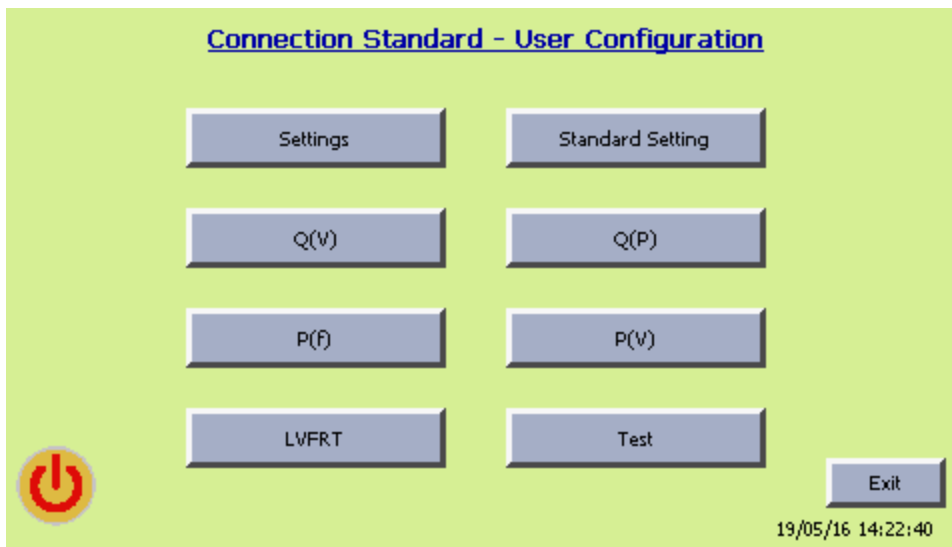

Into the page “Connection standard – Standard Setting” is possible to automatically set the default values valid for the different country where the inverter will be installed.

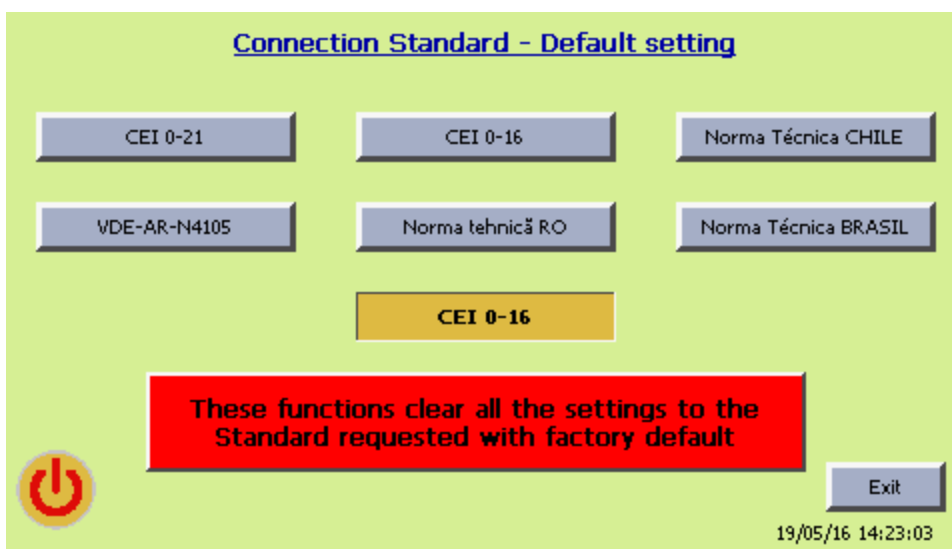

### **Centralized control of the operation of the inverter**

The inverter provides some parameters inside the MODBus protocol available via an RS485 port on the user interface card of the inverter. If a different connection mode (e.g. IEC 61850) will be required by the local distributor then it is under the responsibility of the installer to provide a gateway appropriately configured to perform the functionality in object. Remote commands must be periodically refreshed, because no commands or requests will be rescue permanently in the internal memory of the PV converter (after the shut down or reset of the inverter the default value are upload in the memory and logic of the converter).

#### **Limit of the power in the centralized logic**

The default value of the parameter, whose type is a 32-bit floating point, is -1(no limit) and is readable and writable.

The value equal to 100 corresponds to 100% of P<sub>n</sub>.

Modbus address of the parameter is 35

#### **Trigger for setting the curve Q(V) in centralized logic**

The default value of the parameter, whose type is an unsigned integer, is 0 and is readable and writable.

A value set to "1" enables the programmed feature.

Modbus address of the parameter is 40

#### **Reactive power requirement in centralized logic**

The default value of the parameter, whose type is a 32-bit floating point, is 0 and is readable and writable.

The value is expressed in kVAR and follows the "usual" convention (positive values correspond to a capacitive current injected into the grid by the inverter; the grid consider the inverter like an inductor from its point of view).

Modbus address of the parameter is 33



## Control in local logic

### Setting of the connecting parameter

L'inverter deve verificare la bontà della rete per il tempo indicato prima di connettersi, appena connesso deve erogare potenza con il gradiente indicato.

The inverter must monitor the quality of the grid for the time indicated in the proper setting label before connecting; just after the connection it needs to deliver power with the gradient shown

**Configuration Settings**

Nominal Voltage	260.00 Vn	<input type="checkbox"/> Y (star)
Frequency shift	0.00 Hz/s	
Nominal Power: Pn (kW)	216	216 Sn (kVA)
Connection Pwr Gradient	20 %Pn/min	<input type="checkbox"/> Always Active
Maximum/minimum waiting	60	30 s <input type="checkbox"/> Also Manual
Voltage limits	85	110 %Vn
Frequency limits	49.9	50.1 Hz
P over Q priority	<input type="checkbox"/> Q(x)	6 Minimum Modules
Capacitive = +Q (gen.)	<input type="checkbox"/> Qinc	2592 kVAr/min
PLim Ramp Up/Dw rate	0	0 kW/min

 Exit

19/05/16 14:27:59

### Limit of the feed-in power according to the grid frequency P(f)

This service is related to the stability of the frequency of the grid.

**P(f) Configuration**

Pfm, delay	1	1.000 ms	Pfw1	49.900 Hz
Pfh1	50.300 Hz		Pfw2	50.100 Hz
Pfh2	51.500 Hz		Pft	300 s
Pfl	47.500 Hz		Pfp1	20 %Pimax/min
Pfstat	2.40 %		Pfp2	5 %Pn/min

 Exit

19/05/16 14:28:51

Function	Parametar		Default	Unit	min	Max	Step
P(f)	Pfm	Mode: 0 disabled 1 enabled 2 VDE: it doesn't record them minimum value	0				
	Delay	Delay at start	0	msec	0	1000	50
	Pfh1	First threshold	50.3	Hz			0.005
	Pfh2	Second threshold	51.5	Hz			0.005
	Pfl		47.5	Hz			0.005
	Pfstat	Statism	2.4		2	5	0.005
	Pfw1	Back window value	49.95	Hz			0.005
	Pfw2	Back window value	50.05	Hz			0.005
	Pft	Waiting time in window	300	s			1
	Pfp1	Ramp: % of P before	20	%/min			0.005
	Pfp2	Rampa min: % of max	5	%/min			0.005

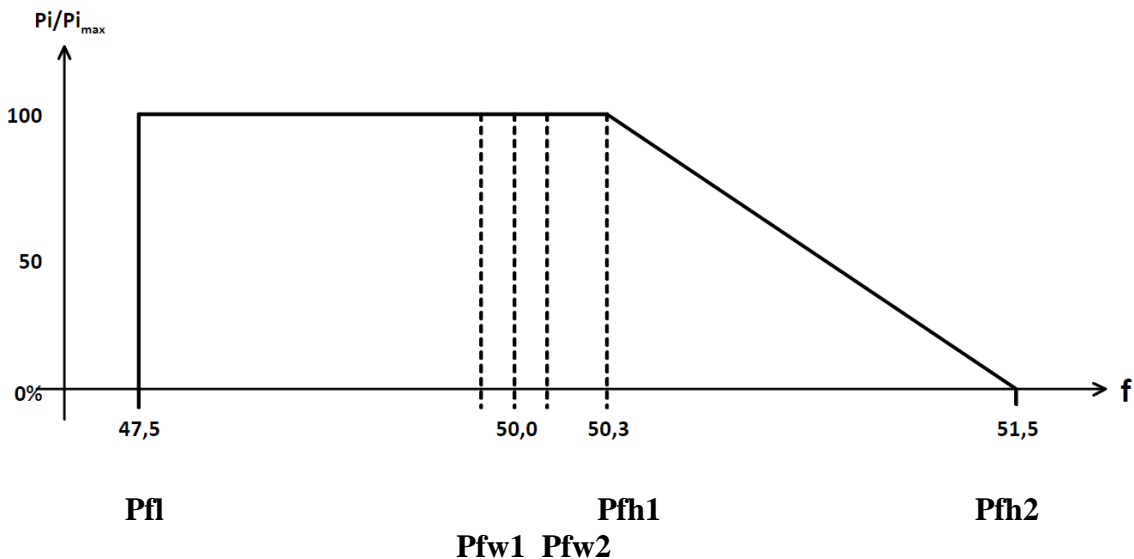

Warning: The parameters Pfh1, Pfh2 and Pfstat are related to each other. Changing Pfh1 or Pfh2 involves an automatic update of Pfstat. The value of Pfstat is not editable, but related to the slope of the curve between Pfh1 and Pfh2.

## Generation of reactive power according to the grid voltage Q(V)

This service is related to the stability of the voltage of the grid.

Q(V) Configuration

QVm, delay	0	3.000 ms	QV1i	92	%V/Vn
QVmin	90	%V/Vn	QV2i	90	%V/Vn
QVmax	110	%V/Vn	QVlk-in	20	%P/Pn
QV1s	108	%V/Vn	QVlk-out	5	%P/Pn
QV2s	110	%V/Vn	QVp1	46.3	%Q/Pn



19/05/16 14:30:01

Function	Parametar		Default	Unit	min	Max	Step
Q(V)	QVm	Mode: 0 disabled 1 lock-in - curve A 2 lock-in - curve B	0				
	Delay	Delay at start	3000	msec	0	30000	1000
	QVmin	Limit inferior then QV1i and QV2i	90	% V/Vn	0	100	0.005
	QVmax	Limit superior then QV1s and QV2s	110	% V/Vn	100	0	0.005
	QV1s			% V/Vn	100	QV2s	0.005
	QV2s			% V/Vn	QV1s	QVmax	0.005
	QV1i			% V/Vn	QV2i	100	0.005
	QV2i			% V/Vn	QVmin	QV1i	0.005
	QVlk-in		20	% P/Pn	10	100	0.005
	QVlk-out		5	% P/Pn		QVlk-in	0.005
QVp1	Qmax			%Q/Pn		0.48	

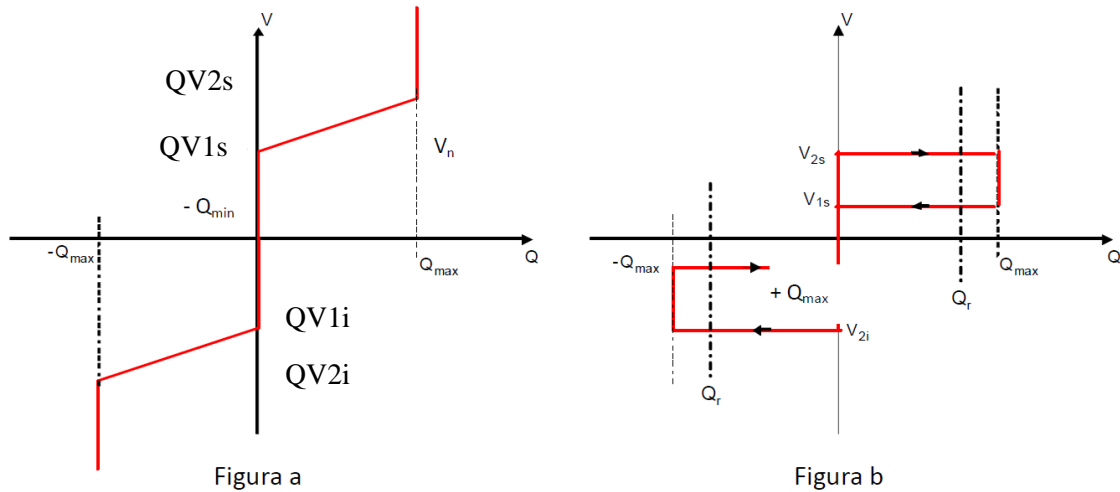

### Generation of reactive power according to the grid power Q(P)

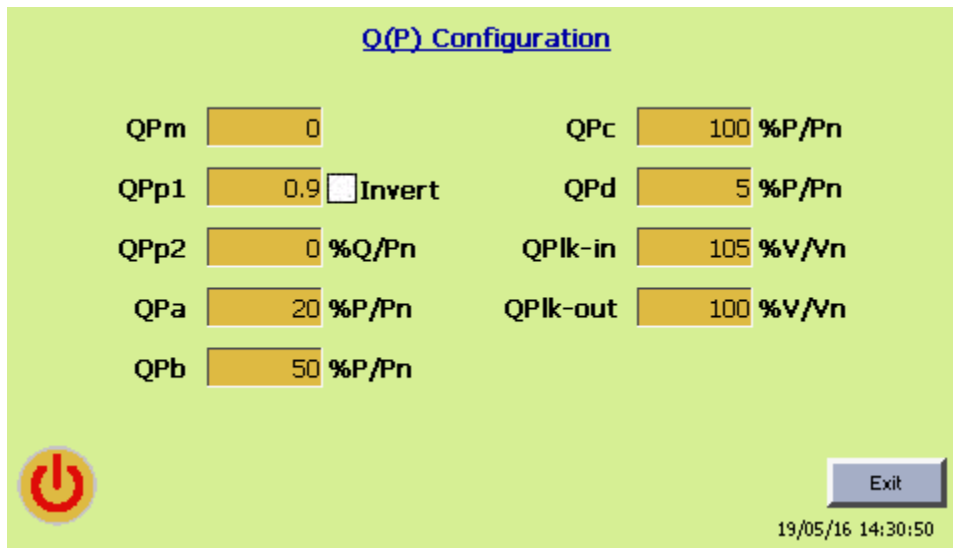

This service is related to the stability of the voltage of the grid.

Function	Parametar		Default	Unit	min	Max	Step
Q(P)	QPm	Mode: 0 disabled 1 fixed rectangular 2 fixed triangular 3 (command) rectangular 4 (command) triangular 5 lock-in - curve A 6 lock-in - curve B	0				
	QPp1	cosφ reactive triangular	1		-0.86	0.86	0.005
	QPp2	Reactive fixed rectangular	0	% Q/Pn	0	48	0.005
	QPa		20	% P/Pn			0.005
	QPb		50	% P/Pn			0.005
	QPc		100	% P/Pn			0.005
	QPd		5	% P/Pn			0.005
	QPlk-in		110	% V/Vn	100	110	0.005
QPlk-out		98	% V/Vn	90	100	0.005	

The "command" is described in the Trigger activation curve Q (V) in centralized logic.  
 The parameter QPp1 refers to the mode 2, 4, 5 and 6, the parameter QPp2 refers to modes 1 and 3. The other parameters are related to modes 5 and 6.  
 The parameters QPIk QPIk-in and-out can be set equal to disable the function of lock-in/out as required by VDE norm.

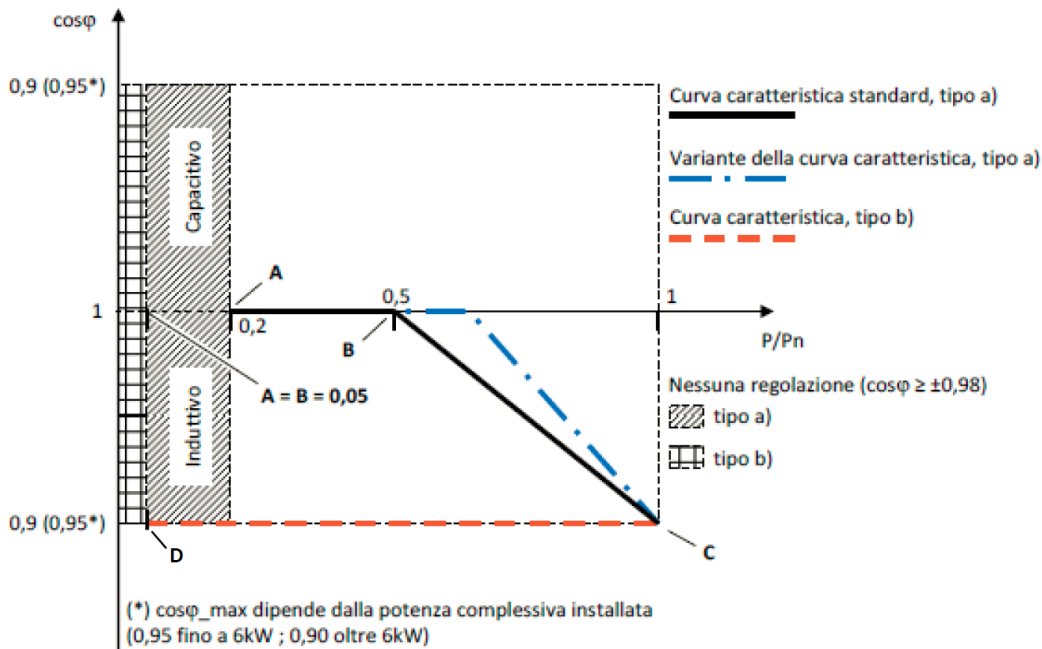

## Reaction to the LVFRT fault of the grid

Un-affection to the grid power fault

LVFRT Configuration

Lm	<input type="text" value="0"/>	Reactive Current Injection	
Lv0	<input type="text" value="0"/> %V/Vn	<input type="checkbox"/> Enable Injection	
Lv1	<input type="text" value="0"/> %V/Vn	<input type="checkbox"/> Reverse Injection	
Lv2	<input type="text" value="85"/> %V/Vn	<input type="checkbox"/> Include Single Phase	
Lv3	<input type="text" value="110"/> %V/Vn	Calc. Threshold	<input type="text" value="100"/> %V/Vn
Lt1	<input type="text" value="200"/> ms	Injection Ratio	<input type="text" value="2.000"/>
Lt2	<input type="text" value="1500"/> ms		

19/05/16 14:31:34

Function	Parametar		Default	Unit	min	Max	Step
LVFRT	Lm	Mode: 0 disabled 1 active	0				
	Lv1	Too much lower	40	%			0.005

		threshold					
	Lv2	Low threshold	85	%			0.005
	Lv3	High threshold	110	%			0.005
	Lt1	Max time under the too much lower threshold	200	ms			1
	Lt2	Max time under the low threshold	400	ms			1

Curve valid according to CEI 0-21

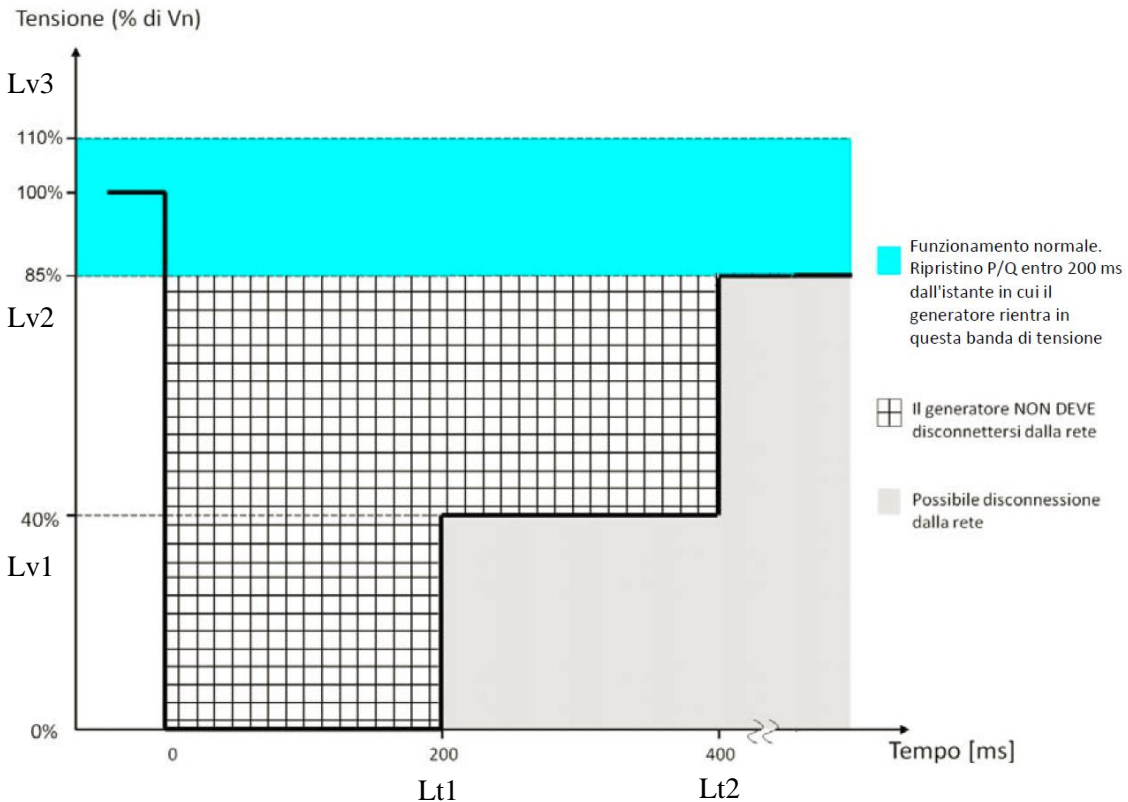

Curve valid according to CEI 0-16, VDE-AR-N-4105, Romanian Norm

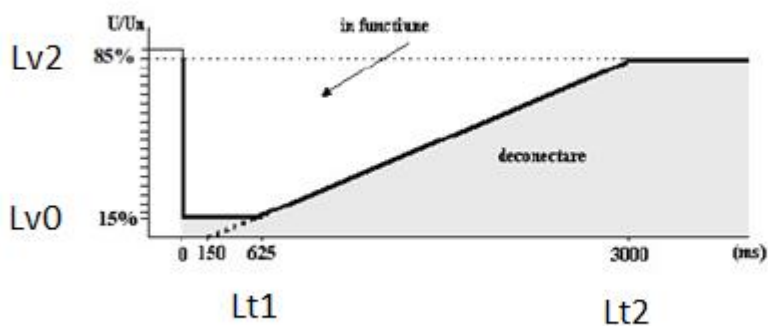

If the Romanian rule is set into inverter parameter, when you return to the area under the curve (gray area) the inverter will disconnect itself from the grid



Questo manuale ottempera agli obblighi del DLgs 14 marzo 2014, n. 49 sulla attuazione della direttiva 2012/19/UE sui rifiuti di apparecchiature elettriche ed elettroniche (RAEE)  
Per RAEE s'intendono i rifiuti di Apparecchiature Elettriche ed Elettroniche (AEE) incluse di tutti i componenti, i sottoinsiemi ed i materiali di consumo che sono parte integrante del prodotto nel momento in cui si assume la decisione di disfarsene.

La Legislazione prevede la suddivisione in 2 categorie principali chiamate RAEE PROFESSIONALI o RAEE DOMESTICI.

**Per lo smaltimento di un RAEE DOMESTICO**

L'utente detentore di un'apparecchiatura elettrica ed elettronica domestica, nel momento in cui decide di disfarsene, può:

- conferirla gratuitamente presso il Centro di Raccolta pubblico (CdR) del proprio Comune (la "piattaforma ecologica");
- consegnarla al negoziante (distributore) nel caso l'apparecchiatura venga sostituita, tramite l'acquisto di un nuovo prodotto con equivalenti funzioni, con una nuova; tale opportunità sarà praticabile solo quando entreranno in vigore le semplificazioni operative per i distributori.

**Per lo smaltimento di un RAEE PROFESSIONALE**

L'utilizzatore professionale, ovvero l'impresa o l'ente che decide di dismettere un'apparecchiatura elettrica ed elettronica deve preliminarmente effettuare una valutazione volta a: individuare se i RAEE, pur provenendo da un'attività commerciale, industriale, istituzionale e di altro tipo, possano essere considerati analoghi ai RAEE originati dai nuclei domestici e quindi procedere come descritto per lo smaltimento domestico.

Nel caso in cui, invece, non vi sia dubbio che l'apparecchio dismesso debba essere qualificato come "RAEE professionale", ovvero rifiuto derivante dall'attività lavorativa e non assimilabile a domestico, è possibile scegliere tra due opzioni:

- contestualmente alla sostituzione dell'apparecchiatura obsoleta con una nuova di equivalente funzione (1 contro 1), l'utilizzatore professionale può richiedere al Produttore dell'apparecchiatura nuova, attraverso l'aiuto del distributore, di gestire la dismissione del suo RAEE professionale;
- l'avvio al recupero secondo le procedure previste per tutti i rifiuti speciali e, di conseguenza, con oneri a carico del produttore del rifiuto.



This product contains electrical or electronic materials.

Fimer as producer of electric and electronic components is in compliance with the European directive 2012/19/UE following the italian DLGS 14 march 2014 N°49.

The presence of these materials may have, if not disposed properly, potential adverse affects on the environment. Presence of this label on the product means it must not be disposed in normal household waste and must be disposed separately.

As a consumer you are responsible for ensuring that this product is disposed properly.

If your supplier offers a disposal facility please use it or alternatively contact your local authority/council to find out how to properly dispose this product.



Dieses Produkt beinhaltet elektrische oder elektronische Materialien.

Fimer als Hersteller von elektrischen und elektronischen Komponenten befolgt die europäische Richtlinie 2012/19/UE nach dem italienischen DLGS 14. März 2014 Nr. 49.

Die Präsenz dieser Materialien konnte negativ die Umwelt beeinflussen, wenn diese nicht richtig entsorgt werden. Dieses Etikett auf dem Produkt bedeutet, es darf nicht im normalen Hausmüll entsorgt werden sondern muss es separat entsorgt werden.

Als Verbraucher sind Sie verantwortlich, dieses Produkt ordnungsgemäß zu entsorgen.

Wenn Ihr Lieferant bietet eine Entsorgungsanlage, bitte verwenden Sie diese oder kontaktieren Sie die Behörde / Gemeinde, um dieses Produkt richtig zu entsorgen.



Ce produit contiène électriques ou électroniques materiau

Fimer comme producteur de électriques et électroniques composants se conforme à la directive européenne 2012/19/UE selon le italien DLGS 14 mars 2014 N°49.

La présence de ces matériaux peut avoir, si non éliminés régulièrement, un effet nocif sur l'environnement.

La présence de ce marque sur le produit signifie que il n'a pas d'être éliminé dans une domestique conteneur et doit etre éliminé séparément.

Comme consommateur Vous etes responsable de l'élimination de ce produit.

Si Votre fournisseur offre un service d'élimination pouvez le utiliser ou pouvez contacter l'autorité locale pour trouver une solution pour éliminer ce produit.



Este producto contiene materiales eléctricos o electrónicos.

Fimer como productor de componentes eléctricos y electrónicos está en conformidad con la Directiva 2012/19/UE europeo siguiendo en italiano DLGS 14 de marzo 2014 N ° 49.

La presencia de estos materiales puede tener si no se eliminan adecuadamente cualquier posible efecto adverso sobre el medio ambiente.

La presencia de esta etiqueta en el producto significa que no se debe colocar en la basura doméstica y debe ser tratado separadamente.

Como consumidor, usted es responsable de asegurarse de que este producto se desecha correctamente.

Si el proveedor tiene una instalación de eliminación por favor, utilice o bien, póngase en contacto con el consejo de la institución / local para averiguar cómo desechar correctamente este producto.



## Inverter for Life

Via J.F. Kennedy  
20871 Vimercate (MB) Italy  
Phone: +39 039 98981  
Fax +39 039 6079334

**www.fimer.com**  
solar@fimer.com



INFOLINE  
Tel. +39-039-6079326



CERTIFICATI  
N°1617 ISO 9001  
N°1618 ISO 14001  
N°1619 BS OHSAS 18001

